

January 1996

Prosodic Morphology 1986

John J. McCarthy

University of Massachusetts, Amherst, jmccarthy@linguist.umass.edu

Alan Prince

Follow this and additional works at: http://scholarworks.umass.edu/linguist_faculty_pubs

 Part of the [Morphology Commons](#), [Near Eastern Languages and Societies Commons](#), and the [Phonetics and Phonology Commons](#)

Recommended Citation

McCarthy, John J. and Prince, Alan, "Prosodic Morphology 1986" (1996). *Linguistics Department Faculty Publication Series*. 13.
http://scholarworks.umass.edu/linguist_faculty_pubs/13

This Book is brought to you for free and open access by the Linguistics at ScholarWorks@UMass Amherst. It has been accepted for inclusion in Linguistics Department Faculty Publication Series by an authorized administrator of ScholarWorks@UMass Amherst. For more information, please contact scholarworks@library.umass.edu.

Prosodic Morphology 1986

John J. McCarthy

Department of Linguistics
University of Massachusetts, Amherst
jmccarthy@linguist.umass.edu

Alan S. Prince

Department of Linguistics & RuCCS
Rutgers University, New Brunswick
prince@ruccs.rutgers.edu

Final Revision: October 25, 1996

Acknowledgments (1986)

This document is excerpted from a longer work now in progress. The research reported here was first presented at the 3rd West Coast Conference on Formal Linguistics held at UCLA on March 29, 1985. Subsequent presentations were made to audiences at the University of Texas, Austin, Brown University, Harvard University, AT&T Bell Laboratories, the Second Seoul International Conference on Linguistics, the Max Planck Institute, and the authors' home institutions. We note with gratitude the contributions of Junko Itô and Armin Mester at various stages, and we thank the audience at the 3rd WCCFL (especially Bruce Hayes and Nick Clements) and our colleagues Lisa Selkirk and Moira Yip for their challenging questions.

Introduction (1996)

This work has circulated in manuscript form since October, 1986. Its basic contents were first presented at WCCFL 3 in spring, 1986 to an audience that was not devoid of convinced believers in the C and the V. It has been cited variously as McCarthy & Prince 1986, M&P forthcoming, and even (optimistically) M&P in press.

Many of the proposals made here have been revised, generalized, or superseded in subsequent work (see the bibliography below, p. 84), including a book ms. of nearly the same title by exactly the same authors. Junko Itô and Armin Mester have suggested to us that it might still be useful to make the 1986 manuscript available through an official venue. Pursuing their suggestion, we are putting the ms. out in final form as a technical report, with a proper and indeed augmented bibliography, with outright errors noted and corrected, and with some added commentary.

We have kept the text very much the same as in the original version. A few trivial mistakes have been corrected silently. More serious missteps are discussed in remarks like this one, interpolated among the paragraphs of the original text. We have also inserted a number of brief comments and pointers to later developments, particularly when they have extended (or put shut to) a theme raised in these pages. For convenience, these scholia are included in the table of contents, in the same distinctive typeface.

Preparation of this document was supported by the National Science Foundation (grant SBR-9420424) and Rutgers University. We owe a large debt to John Alderete and Jill Beckman, whose assistance was indispensable.

John McCarthy

Alan Prince

Table of Contents

1.	Introduction	1
1.1	Templatic Morphology within Prosodic Theory	1
	Counting Allomorphy	2
	The XXX Template	3
1.2	Outline of the Theory	5
	The Prosodic Categories	6
	Minimal Word	6
	More on the Minimal Word	7
	Foot Typology	7
	Foot Theory	8
	Mapping Principles	9
2.	Elaboration and Exemplification	10
2.1	Prefixation	10
	The Simple Syllable as Prefix Target	10
	Ilokano Reduplication	10
	Orokaiva Reduplication	12
	ONSET, Templates, & Alignment	13
	The Core Syllable as Prefix Target	13
	The Core Syllable	13
	Sanskrit Vowel-Initial Reduplication	15
	The Heavy Syllable as Prefix Target	16
	Mokilese	16
	Quantitative Transfer	17
	Ponapean: Heavy and Light σ as Prefixes	19
	More on Ponapean	19
	Ponapean I: Consonant-initial Stems	19
	Ponapean II: Vowel-Initial Stems	23
	Ponapean III: Conclusion	24
	Ponapean IV: Proleptic and Historical Note	24
	Minimal Word/Foot as Prefix	24
	Diyari Reduplication	25
	Lardil Phonology	25
	Reduplication in Yidiñ and Lardil	29
	Makassarese Reduplication	29
	Prosodic Reparsing	30
2.2	Suffixation	30
	The Minimal Word or Foot as Suffix Target	30
	Manam Stress	31
	The Syllable as Suffix Target	32
	Alignment in Suffixing Reduplication	32
	Kamaiurá Reduplication	34
2.3	Infixation	34
	Infixation via Extraprosodicity	35
	Prefix as Infix	35
	Infixing Reduplication	38
	VC Infixation	39
	Uradhi and Timugon Murut Reduplication	40
	Washo Reduplication	43
	Suffix as Infix	43
	Korean Reduplication	43
	Infixation via Affixation to a Prosodic Constituent	44
	Infixation by Affixation to Prosodic Constituent	45

2.4	Templatic Morphology	45
	Truncation	45
	More on Truncation	47
	<i>Zuuja-go</i>	48
	Templatic Well-formedness Requirements	50
	True Templatic Morphology	51
	Semitic	51
	More on Semitic Morphology	52
	Cupeño	54
	Other Templatic Morphology	55
3.	Other Issues in Templatic Structure	55
3.1	Syllable-internal Structure	56
	Moraic Theory	56
	Intrasyllabic Structure	57
	Tübatulabal Reduplication	58
	Language Games	60
3.2	Prespecification?	61
	Tone	63
	Fixed <i>i</i> in Yoruba Reduplication	63
	The Fixed High Vowel in Akan Reduplication	65
	Melodic Overwriting	68
3.3	Contour Segments	69
	Affricates	69
3.4	Phonological Consequences	71
	Compensatory Lengthening in Moraic Theory	72
4.	The Nature of the Mapping Relation	73
4.1	Melody Copying on the Same Tier	73
	Edge-in Association & Alignment	74
	Base/Reduplicant Identity	75
4.2	Melody Copying on a Different Tier	75
4.3	Synchronous Skeleta	77
	Overapplication, Transfer	77
4.4	Line Crossing	79
	Line-Crossing Theory	80
	Dorsey's Law	81
	Bibliography	84

1. Introduction

1.1 Templatic Morphology within Prosodic Theory

A central strategy for deriving words requires that a base accommodate to a target frame: the invariant that identifies a morpheme lies in its overall shape rather than in its phonemic composition. The reduplicative perfect prefix of Indo-European is always (C)V; its content is borrowed from the root. The causative/factitive ‘measure II’ of the Classical Arabic verb conforms to the pattern CVCCVC. Such descriptive observations lie at the heart of recent studies of reduplicative and root-and-pattern morphologies. Here we will inquire into the nature of the targets used in such systems: we will show that they must be defined in terms of the categories and rules of prosody, as provided by the theory of syllabification, stress, and accent. Our immediate goal is to provide a basis for nonconcatenative morphology; our broader goal is to circumscribe the modes of reference to structural information in phonology; and to characterize the class of structures that are authentically essential to phonological representation.

Basic findings in prosody place strong conditions of adequacy on template theory. It is worth examining the chief interactions, since we can immediately rule out many plausible-seeming approaches while establishing the general constraints within which template theory must work.

Consider first the role of **counting** in grammar. How long may a count run? General considerations of locality, now the common currency in all areas of linguistic thought, suggest that the answer is probably ‘up to two’: a rule may fix on one specified element and examine a structurally adjacent element and no other. For example, the ‘End Rule’ of Prince (1983) focuses on one edge of a domain and selects the element adjacent to that edge for some specified operation; similar cases can easily be multiplied.

What elements may be counted? It is a commonplace of phonology that rules count moras (μ), syllables (σ), or feet (F) but never segments. Many languages place a two-mora bound on the minimum size of major-category words; this follows from the prosodic hierarchy, if prosodic words must contain feet and feet can be no smaller than 2μ . Exactly this state of affairs is demonstrated for Estonian in Prince (1980); an interesting side-effect is that the rule of apocope apparent in the nominative singular is blocked when its output violates this condition:¹

(1) Estonian Word Minimality

a. /kana/	kana	*kan	‘chicken, nom.sg.’
b. /konna/	kon:n		‘pig, nom.sg.’
c. /tänav/	tänav		‘street, nom.sg.’

Final consonants are provably extrametrical, so that no form like *kan is admissible as a noun. In Kyoto (Kansai) Japanese, where the one allowed final consonant (N) is fully moraic, content words shaped CV are excluded: all historically monomoraic items have been lengthened (CV > CV:) to conform to the 2μ limit. A typical variation is reported for Caughnawaga Mohawk in Michelson (1981): verbs must be disyllabic, and undersized collocations of morphemes are expanded by epenthesis.

(2) Mohawk Word Minimality

a. /k + tats + s/	iktats	‘I offer’
b. /hs + yaʔks + s/	ihsyaʔks	‘you are cutting’

Crucially, Mohawk prosody is insensitive to the light/heavy distinction, so that F is minimally $[\sigma]$.²

¹ A similar point is made about apocope in Lardil by Wilkinson (1986).

² We might say $\mu=\sigma$ in such cases.

Counting restrictions often determine nonphonological allomorphy as well. In Dyirbal (Dixon 1972), by a kind of compensation, the ergative suffix is bimoraic *-ŋgu* with minimal (disyllabic) bases but monomoraic *-gu* with longer ones.

(3) Dyirbal Size-based Allomorphy

a. /yaʃa/	yaʃa-ŋgu	‘man’
b. /yamani/	yamani-gu	‘rainbow’

A short word contains a single F; a long word, something more.³ In English, comparative *-er* and superlative *-est* are pretty much restricted to minimal (monopod) words:

(4) English Size-based Allomorphy

a. redder	stupider	noblest
b. yellower	*obtuser	*augustest

Outside the realm of morphology proper, we find that the *to*-dative alternation in English is essentially limited to one-foot verbs (Grimshaw 1985): thus, ‘give/offer the men the ball’, but * ‘donate the men the ball’.

Counting Allomorphy

An analysis of syllable/mora-counting allomorphy in terms of prosodic circumscription is offered in McCarthy & Prince 1990a. A different account, based on prosodic subcategorization, is put forward in M&P 1993a: Chapt. 7. Other recent work includes Mester 1995 and Kager 1996ab.

No language process, however, is known to depend on the raw number of **segments** in a form: a robust finding, given the frequency and pervasiveness of counting restrictions. It should come as no surprise that templatic morphology can’t count segments either. If a reduplicative prefix target could be XXX — three segments, unadorned with prosodic structure — the following impossible type of system should be common:

(5) Hypothetical XXX Reduplication

a. badupi	→	BAD badupi
b. bladupi	→	BLA bladupi
c. adupi	→	ADU adupi

What’s prosodically incoherent here is the segmental equation of monomoraic BLA with bimoraic BAD and ADU.

It is striking, then, that current theories of template form are essentially segmental, allowing prosodic annotation as an option or alternative to be called on when necessary. The CV-theory of McCarthy (1981), taken up in Marantz (1982), has been generalized to the syllable-point theory of Lowenstamm & Kaye (1986) and the X-theory of Levin (1983), most extensively explored in Levin (1985). In the syllable-point theory, uncharacterized segmental skeletal nodes are seen as dependents of syllables. In the X-theory, in its various instantiations, a level of segmental structure, unmarked for the C/V distinction, is distinguished by higher-level prosodic structure. Although studies conducted within these theories have vastly increased our knowledge and understanding of templatic systems, their basic representational assumptions cannot stand. Templates by their nature count elements: CV- or X-theories must count segments, and must count many of them. Consider the template-of-templates that generates the various forms of the Classical Arabic verb:

³ Word-length distinctions are made on similar grounds in Biblical Hebrew (Dresher 1983), Japanese (M. Liberman, reported in Poser (1984b)), and Ponapean (see section 2.1). Other cases of counting allomorphy abound — Spanish (Harris 1979), Pukapukan (Chung 1978), Maaori (Biggs 1961) — all referring to syllables or moras.

(6) Segmental Skeleton for the Arabic Verb

a. (C) C V (X) C V C

N N

| |

b. (X) X X (X) X X X

By this, 7 segments must be counted. Our proposal (in section 2.4) will be that the template is $[\sigma \sigma]$, the familiar count to 2, with extrametricality allowing for the extra initial position. Within X-theory, the simplest and therefore most highly valued templates are purely segmental: indeed Levin (1985) proposes that the (impossible) template XXX is attested in Mokilese: below, we show that the actual template is $\sigma_{\mu\mu}$, a heavy syllable. The descriptive success of XXX is an artifact of the restricted syllable structure of this language.

The XXX Template

In fact, what Levin 1985 proposes is that the Mokilese template is $[XXX]_{\sigma}$, not bare XXX. (The erroneous attribution in the text is a result of consulting a low-quality photocopy of Levin 1985.) The point still holds, though. In segmentalism, XXX is the simplest and therefore most highly valued template, yet it is factually impossible. Moreover, even with a syllabic appurtenance, as in $[XXX]_{\sigma}$, it still characterizes a factually impossible situation of segment counting, in which there is an equivalence among the prosodically disjoint set CCV, CVV, CVC, and VCC.

Alone among students of the template, Hyman (1985) has rejected a segmental level of representation in favor of a weight structure that is essentially moraic. Our results, although largely complementary to his, bear significant resemblances to his work.

The fundamental goal of a template representation system must be to characterize the shape-invariant that unites the various allomorphs. Here prosody diverges notably from segmentalism. If we say that the template is $[\sigma]$, then all segmental sequences comprising a licit syllable of the language are in the equivalence class: {V, CV, CVC, CCVC}, for example, would be a typical set of realizations. Since no single segmental string is conserved, segmentalism must supplement the representational theory with principles that serve to equate strings in the set. Following Marantz (1982), segmental theories spell out the template as the longest observed realization (or even the union of the observed realizations, if distinct from the longest); when an insufficiency of melody leaves template slots empty, they are discarded. The distinction between the two approaches can be made clear with an example. In the Philippine language Ilokano, the progressive is formed by reduplicative prefixation, as shown below:

(7) Reduplication in Ilokano

a. /basa/	ag - BAS - basa	'be reading'
b. /adal/	ag - AD - adal	'be studying'
c. /takder/	ag - TAK - takder	'be standing'
d. /trabaho/	ag - TRAB- trabaho	'be working'

Segmentalism must analyze the prefix as CCVC, explicitly counting out the maximal monosyllable.⁴ We propose that the target is simply σ ; given a copy of the bare melody, it satisfies itself to the fullest extent allowed by the usual rules of the language.

(8)

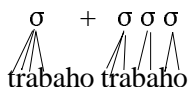

Notice that stem syllabification is inhibited by the usual onset priority considerations, hence [tra][ba]...; the prefix σ faces no such competition, hence [trab].

As example (7) illustrates, segmentalism is typically faced with an excess of underlying slots. There are well-known ways in which unfilled slots influence phonology and morphology (Selkirk 1981, Clements & Keyser 1983, Marlett & Stemberger 1983, Lowenstamm & Kaye 1986). It is a remarkable fact that empty templatic slots have never been convincingly detected outside their endo-theoretic role in melody association.⁵ We conclude that they do not exist.

In essence, segmentalism must hold that all template elements are optional until proven otherwise. It is thus in principle incapable of specifying, in the representation, that certain elements are obligatory, a common situation. We show below that the reduplicative prefix in Ponapean is a heavy syllable: segmentally, this means CVX, with the X required and the C optional. The additional conditions follow immediately from the syllabic characterization, since onsets are optional initially in the language and heavy syllables must of course have a postnuclear element. Nothing in the segmental theory guarantees this result.

One final observation seals the case against excess elements in templates. It is a stable empirical finding that templates imitate — up to extrametricality — the prosodic structure of the language at hand. There is no Arabic template CVCCCVC; correlatively, the syllabification of the language disallows triconsonantal clusters. Segmental theory, however, cannot derive this result. Since excess or stray elements are erased, they are free to occur, and indeed must occur in other circumstances. Were they present, even fleetingly, they could perturb melody association in easily discoverable ways. For example, the Arabic template CVCCVC, with which *CVCCCVC would be neutralized, requires special conditions to override left-to-right association; these could be stated to make a phony distinction between CC and *CCC, introducing an otherwise inexpressible contrast into the language. In this way a pseudo-contrast in the CV-domain, protected from surfacing by stray erasure, can be projected into the melodic domain, where it would survive to visibility. Section 2.4 contains further discussion of the Arabic case.

Within prosodic theory, where the actual shape-invariant can be identified, it is possible to assume a natural condition on template interpretation:

⁴ Notice that syllable theory proper doesn't even do this kind of extensive counting: most syllable length restrictions follow from pairwise sonority transition requirements; the rest from hierarchy. Discussion appears in section 3.1.

G.N. Clements has suggested to us (April, 1985, p.c.) that a descriptor C* could be used to refer to consonant sequences of unspecified length. The development of prosodic theory has eliminated such devices from phonological rules proper; it seems worthwhile to us to extend the result generally.

⁵ The one argument in the literature which crucially relies on unfilled template slots is Everett & Seki (1985); we deal with it below in section 2.2.

(9) Satisfaction Condition

All elements in a template are obligatorily satisfied.⁶

All three of the problems stemming from segmental shape specification are resolved:

- i. Under the Satisfaction Condition no excess material is ever present in the representation, giving us the easiest and least stipulative explanation for its unresponsiveness to phonological probing: nonexistence.
- ii. Patterns of obligatoriness and optionality will follow in general from independent characterization of the prosodic units, both universally and language-specifically. (This is merely a somewhat tardy extension of reasoning well-established in phonology, where such optionality-stipulating notations as ‘(...)’ and zero-subscript have faded in the face of accurate representation of prosody.)
- iii. The fact that the templates are bounded by a language’s prosody follows from their being literally built from that prosody.

The actual shape-invariant defining a templatic morpheme must be prosodic, then, rather than segmental. Even at this descriptive level it becomes clear when languages with moderately complex prosody are examined that prosodic categories must be admitted into template theory. ‘CVC’ seems a plausible enough prefix; but when the next language over (e.g. Ilokano instead of Agta), shows ‘CCVC’, correlated with the appearance of 2-consonant onsets, it becomes harder to avoid the correct generalization. The Classical Arabic templates appear relatively simple (though, as noted above, spelled segmentally they violate counting norms); turn to Modern Hebrew, with a rich range of syllable-initial clusters to include, and the stipulative character of segmental spell-out becomes apparent (McCarthy 1984c; section 2.4 below). Nash (1980, p.139) identifies the Warlpiri verbal reduplicative element as a foot, indeed as the ordinary stress-foot of that language, because it equates a single long-vowelled syllable to two short-vowelled syllables. In fact, the literature demonstrating the need for reference to prosodic structure in characterizing morphological structure is quite substantial; in addition to the works just cited it includes Archangeli (1983, 1984), Lowenstamm & Kaye (1986), Yip (1982, 1983), Steriade (1985), Levin (1983, 1985), and Marantz (1982). What these works share is a concern with showing the necessity for prosody in the template; but they also share the recognition of a segmental level of skeletal representation.

Template theory therefore includes prosody; considerations reviewed here from counting theory and from the expression of shape invariance show that it must include nothing else. The rest of this document constitutes a *demonstratio* (in the sense that brought Galileo before the Inquisition) of this result.

1.2 Outline of the Theory

Here we sketch the system of available categories and the principles of mapping that accommodate a base to a prosodically specified template.

⁶ Condition (9) is probably a special case of the general principle for interpreting structural descriptions throughout phonology. As the notion of strict adjacency at the appropriate level (tier, grid stratum) replaces string specification devices, it becomes likely that no language-specific stipulation of optionality is allowed in rules.

THE PROSODIC CATEGORIES

The following units of structure will be called on:

(10) The Prosodic Categories

Wd	‘prosodic word’
F	‘foot’
σ	‘syllable’
σ_{μ}	‘light (monomoraic) syllable’
$\sigma_{\mu\mu}$	‘heavy (bimoraic) syllable’
σ_c	‘core syllable’

These elements are well-established outside of morphology. The theory of phonology uncontroversially recognizes the categories ‘prosodic word’ (Wd) and ‘syllable’ (σ). Stress theory provides the categories ‘foot’ (F), ‘light syllable’, and ‘heavy syllable’. We adopt the traditional moraic terminology: light syllables (σ_{μ}) contain one mora, heavy syllables ($\sigma_{\mu\mu}$) two (v. Hyman (1985), Prince (1983) for recent discussion). Studies of syllabification proper have long recognized the centrality of the syllable CV, the ‘core syllable’ (σ_c). We interpret σ_c to include $\sigma = V$ in languages which allow optionality of onsets.⁷ The prosodic units are arranged hierarchically (v. Selkirk (1980ab) for the most explicit discussion of this point).

Special status is often accorded to the **minimal** version of a category; we therefore recognize as part of morphology a minimizing predicate ‘min’. In general, if X^n is a level-n prosodic category expanding into several categories X^{n-1} , then $\min(X^n) = [X^{n-1}]_{X^n}$. For example, a prosodic word is typically a sequence of feet; so $\min(Wd) = [F]_{Wd}$. Appropriate technical development, which we postpone, would simplify the descriptive vocabulary in favor of a more restricted set of categories interacting with the ‘min’ operator: σ_c can be identified as $\min \sigma$, and perhaps $\sigma_{\mu\mu}$ as $\min F$.

Minimal Word

Further formal development is found in M&P (1990a, 1991ab). One refinement that emerges in this work is the “loose” minimal word, which contains a foot plus an unfootable syllable, in a loose interpretation of the prosodic hierarchy (cf. M&P 1993a:Appendix, 1995a; Itô & Mester 1992; Hewitt 1992).

The category $\min Wd$ is particularly central; indeed, the many appearances of the category word in reduplicative and templatic systems all have the minimality requirement attached. There’s an interesting variation in interpretation of $\min Wd$ which shows that the min-operator can be composed with itself at least once: in 2.4.1 below, we show that $\min Wd$ may be any licit foot of the language, as in the Yup’ik proximal vocative, or it may be the minimal Foot which can yet be a word, that is to say a single syllable, as in the English hypocoristic: $\min \min Wd$.

⁷ There are various ways to guarantee this interpretation. In essentially the terms of Steriade (1982), one can say that the primary act of syllabification is to adjoin at most one C to a following V — the Onset Rule. This is Hyman’s (1985) conception of the creation of the elementary mora. This is distinct from, say, Kahn’s conception in which the primary move is to associate σ to V. Then σ_c indicates an application of this primary adjunction, which may fail to create CV if there’s no C to take.

More on the Minimal Word

The notion “minimal word” builds on earlier work by Prince 1980 and Broselow 1982. Subsequent literature on the minimal word in phonology includes: Akinlabi 1995; Buller, Buller, & Everett 1993; Dunlap 1991; Golston 1991; Hayes 1991/1995; Itô & Hankamer 1989; Kager 1993b, 1996a; Kiparsky 1992; McDonough 1990; Mester 1993; Myers 1987; Orgun & Inkelas 1992; Piggott 1992; Prince & Smolensky 1993; Wilkinson 1986. Work on the minimal word in morphology includes: Cho 1992; J. F. Cole 1990; Crowhurst 1991ab; Itô 1991; Itô, Kitagawa, & Mester 1992; Itô & Mester 1992, 1995; McCarthy & Prince 1991ab; Mester 1990, 1995; Ola 1995; Spring 1990ab; Tateishi 1989; Weeda 1992; Yip 1991. In M&P 1994ab, we argue that the minimal word has no actual status as a primitive template — instead, it is just the most harmonic form of PrWd under the metrical constraints PARSE-SYLL and ALL-FEET-RIGHT/LEFT

A final point. Nothing in our proposals hinges on any conception of the mora as a unit of intrasyllabic constituency beyond its essential role in measuring weight. Thus, although we adopt the notational expedient of adjoining, for example, the onset to the first mora of each syllable, this in no way bears on our results. Instead, the issue of appropriate intrasyllabic constituency is addressed on its own terms in section 3.1.

FOOT TYPOLOGY

The repertory of feet that we require will differ somewhat from that made familiar in the work of Halle-Vergnaud (1978) and Hayes (1980); in particular, we will need to recognize the foot $[\mu \mu]$. We will therefore propose and justify a modified universal typology, which is closer to the practice of McCarthy (1979) and Prince (1980), and which reflects the findings of Hayes (1985).

Our first assumption is that feet are maximally binary; ‘unbounded feet’ are nonprimitive, as demonstrated in Prince (1985). We distinguish between two fundamental foot-types on the basis of the quantitative relation between the two members: the balanced foot $[u u]$ and the asymmetrical foot $[v w]$ where $v < w$ (in practice, $[\sigma_\mu \sigma_{\mu\mu}]$). In his (1985) study of alternating patterns, Hayes found that in quantity sensitive (QS) systems heavy syllables are always foot-final; he points to the psychology of grouping temporal sequences as the cause. The asymmetrical foot must therefore be quantitatively iambic.

A second important finding of Hayes’s is that quantity-insensitive (QI) feet are overwhelmingly trochaic in labeling. Here again he points to the psychology of grouping: a sequence of objectively even pulses is typically parsed as trochaic (cf. 2/4 and 4/4 time). We therefore assume two prominence principles responsive to quantitative relations.

- (A) **Quantity/Prominence Homology.** for $a, b \in F$, if $a > b$ quantitatively then $a > b$ stresswise.
 (B) **Trochaic Default.** for $a, b \in F$, if $a = b$ quantitatively then $F = [s w]$.

In languages which do not recognize distinctions of quantity, only rule (B) applies; feet being of the balanced variety, they are necessarily trochaic. In languages distinguishing heavy and light syllables, the bracketing is as we predict: feet are $[\sigma_\mu \sigma_{\mu\mu}]$, $[\mu \mu]$, and when permitted $[\mu]$. The assignment of prominence shows some interesting variations. If (A) and (B) were the only principles involved, we would expect that quantity-sensitive systems would have both iambic and trochaic feet in them: iambic on the asymmetrical feet, trochaic on the balanced feet. Such systems are in fact attested: Cairene Arabic (McCarthy 1979) has exactly this pattern. But the most commonly encountered system has $[w s]$ prominence on all feet, regardless of their quantitative make-up. We propose that this is due to a requirement of uniformity which has more to do with the integrity of the system than with its phonetic bases. If a quantity-sensitive language is to have a single labeling rule, it must be $[w s]$, since Quantity/Prominence homology cannot be systematically denied. A third type of system enforces uniformity of labeling only within individual words: the example is Yidij (Hayes 1985). Words are bracketed into bisyllabic feet from left to right; then quantity sensitivity is invoked: long vowels are shortened in foot-initial

position, leaving only legitimate balanced or asymmetrical feet. Any word containing an asymmetrical foot has iambic rhythm throughout; words with only balanced feet are trochaic. We can express this typology of quantity sensitivity in this way:

(C) Uniformity Parameter

A language may require that all feet have the same labeling (i) everywhere (ii) within the word.

The three principles (A), (B), and (C) have somewhat different status. Principle (A) ‘Quantity/Prominence Homology’ is dominant: the familiar QS systems all observe it. Principle (C) ‘Uniformity’ is parasitic upon (A), and as a parameter of description, it may be turned off, as in Cairene. Principle (B) ‘Trochaic Default’ is typically a true default rule, subject to overrule by ‘Uniformity’.

The range of possible prosodic systems is generated by the various possible combinations of foot-types and prominence rules. There’s only one QI system, with the balanced foot $[\sigma \sigma]$, necessarily trochaic. Three major QS systems emerge:

- [I] using both feet $[\sigma_\mu \sigma_{\mu\mu}]$ and $[\mu \mu]$,
- [II] using only $[\sigma_\mu \sigma_{\mu\mu}]$,
- [III] using only $[\mu \mu]$.

System [I] is of course the usual QS alternating pattern, with a (possibly dominant) iambic component. System [II] is the ‘unbounded foot’ type and may be supplemented by the placement of a (balanced) foot at word-edge (Prince 1985). System [III] is found in Japanese (see Poser (1985 [1990]) and below) and may also be attested in Southern Paiute (Sapir 1930) and Weri (Boxwell & Boxwell 1966; Hayes 1980).

The Southern Paiute case deserves some discussion. The language is remarkable in having a stress rule that can evidently divide long vowels between feet. According to Sapir’s description, the stress pattern is generated by applying feet $[\mu \mu]$ left-to-right, where $\mu=V$ and long vowels are VV. In such word-shapes as CV-CVV-CV..., this results in syllable-splitting, giving $[CV-CV][V-CV]$. Although this is unusual, the truly odd thing from the present point of view is that the feet are iambic.

A further datum bears on the matter: R. Harms (1966) and K. Hale (p.c.) report that there is a surface difference between true long vowels and underlyingly heterosyllabic VV sequences ($<*VGV$): whereas the sequences may surface iambically stressed, the true long vowels always have phonetic stress on their initial mora. We take this to be the result of a rule erasing syllable-internal foot structure and assigning prosodic status to σ , which allows the normal prominence structure of the syllable to assert itself. In certain environments, such a rule will derive feet $[\sigma_\mu \sigma_{\mu\mu}]$. Consider the crucial example $[CV-CV][V-CV]$: adjusting σ -internal F-structure gives $[CV-CVV][CV]$. If this is right, the Southern Paiute system does indeed contain the crucially iambic foot $[\sigma_\mu \sigma_{\mu\mu}]$. At prominence assignment, uniformity may be invoked to guarantee iambic labeling.

An important consequence of this system is that iambic rhythm is crucially dependent upon the appearance of heavy syllables in a language. (Curiously, this does not follow from previous theories even if iambicity is directly linked to QS. For QS, as a property of rules rather than representations, can be defined in such a way that a given language has no candidates for heavy syllables: for example, suppose the quantity distinction is set at V/VV in a language without long vowels.) Iambic rhythm is phonetically proper only to asymmetrical feet; uniformity spreads it to balanced feet.

The revised typology argued for here provides exactly the feet we shall encounter in templatic systems: QI $[\sigma \sigma]$ and QS $[\sigma_\mu \sigma_{\mu\mu}]$ and $[\mu \mu]$.

Foot Theory

A similar foot theory was independently proposed by Hayes 1987. Subsequent developments of this theory include Prince 1991, Hayes 1991, 1995, Hewitt 1992, Kager 1992a, 1993ac, and Mester 1995.

MAPPING PRINCIPLES

Accommodation to a template is essentially the prosodic reparsing of a copy of the base. Under this rubric there are many variations consistent with the general prosodic hypothesis that we wish to establish: here we sketch one approach, deferring detailed discussion of alternatives (in part until section 4) on the grounds that choice between them, though of great empirical interest, is largely orthogonal to the main issue. In order to highlight the main line of argument — the prosodic character of template structures — we will for now refrain from radical revision of the mapping process.

We'll assume with Marantz (1982) that the entire segmental melody of the reduplication domain is copied; with Broselow & McCarthy (1983-4), that it is copied onto a new plane, although we will not carefully represent this where non-crucial.

We also assume that mapping of the segmental material into the template is directional: LR for prefixes, RL for suffixes, free choice for root-and-pattern systems. For reduplicative affixation, this presumably boils down to the fact that the affix occurs at an edge: prefixes reprosodize at the beginning, suffixes at the end of the domain (-copy). Call this edge-in reprosodization; we return to it below.

Current views require emendation, under any conception of template form, in their handling of template/melody mismatch. Free loss of melodic material under phoneme-driving leads to false predictions. Consider the prefix σ , commonly treated as CVC in languages where that is the maximal syllable. What happens when it attaches to a word of the form CV.VC? The Ilokano progressive provides an example:

- (11) “No-Skipping” in Ilokano Reduplication
 /dait/ ag-DA-da.it ‘sew/ be sewing’

When /i/ fails to map, persistence in the LR sweep should extend the search to the final /t/, predicting **ag-DAT-da.it*, a pattern of loss that appears to be impossible. The same effect is met with in the other direction — see the discussion of Manam in 4. The doctrine of persistence is motivated by actual losses observed in CV (that is, σ_c) reduplication. For example, Sanskrit *druv-* > *DU-druv-* ‘run’ shows that failure of a C (here, *r*) to map does not prevent association from continuing until the target is satisfied. The persistence doctrine vastly overgeneralizes from this one pattern. Aside from mapping to σ_c , there are no other cases where nonadjacent melody elements are rendered adjacent by directional mapping to template: loss occurs freely only when the mapping process is finished and the continuous substring left over disappears, as in *ag-TAK(der)-takder*, *ag-DA(it)-dait*, etc. Stem-template systems are similar, when they allow any loss from the root, e.g. Arabic quinqueliterals (McCarthy 1981).

A plausible account of this finding is that mapping must always be continuous, except that under compulsion the head of a constituent such as onset can be taken for the whole thing. We will put off explicit technical development, however, since competing theories offer no advantage in dealing with the problem, and simply assume that skipping of melody elements is impossible outside accommodation to σ_c . It is not implausible that the mapping operation actually defines σ_c : if the core syllable is removed from the vocabulary of prosodic constituents, it can be derived from the light syllable (σ_μ) by this idiosyncratic mode of mapping. As before, we postpone technical development of this possible simplification.⁸

A related issue also emerges from our results. The otherwise reduplication-specific principle of phoneme-driven association (Marantz 1982) turns out to be superfluous. With a prosodic theory of the skeleton, association is effectively skeletally-driven⁹ — it is edge-in reprosodization of the copied melody by the affixal skeleton. We develop this consequence of our theory explicitly in section 4.

⁸ It is possible, for example, that the mapping observed in σ_c is related to the notion “minimal affix”.

⁹ Davis (1986) proposes skeletally-driven association only for infixes; we regard it as universal.

Finally, we will follow Broselow & McCarthy (1983–4) in assuming that the domain of affixation may be delimited prosodically as well as morphologically. In particular, the notion *min Wd* may be called on to pick out a subsequence of the stem which can serve as a kind of pseudo-stem for purposes of affixation and associated processes. This notion of domain is important not only in certain types of infixing reduplication but in peripheral reduplication as well.

2. Elaboration and Exemplification

In this section, we look at three types of reduplication, prefixation, suffixation, and infixation, and then turn to nonreduplicative templatic morphology.

2.1 Prefixation

THE SIMPLE SYLLABLE AS PREFIX TARGET

A common form of reduplication prefixes to the base as much of its initial substring as can be put into a syllable of the language. The Ilokano progressive, cited above, provides a clear example (Bernabe et. al. 1971):

(12) Ilokano Progressive Reduplication

BASE	<i>ag + σ + BASE</i>	
a. /basa/	ag - BAS - basa	‘be reading’
b. /dait/	ag - DA - da.it	‘be studying’
c. /adal/	ag - AD - adal	‘be studying’
d. /takder/	ag - TAK - takder	‘be standing’
e. /trabaho/	ag - TRAB- trabaho	‘be working’

It has been emphasized in the literature that reduplication does not in general **copy** a prosodic constituent of the base (Moravcsik 1978); forms such as *ag.BAS.ba.sa* confirm the observation. What’s copied is the base’s segmental melody, as in Marantz (1982);¹⁰ the prefix σ then draws its content from that melody according to the syllabification rules of the language.

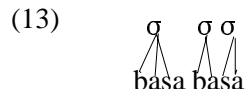

The difference between the prefix syllable *bas* and the stem-initial syllable *ba* is explained by the different prosodic requirements placed on the two domains. Since the stem must be through-syllabified, its syllable *ba* is limited by competition from the following syllable, which maximizes its own onset; the prefix syllable *bas*, being alone in its domain, is free to develop to the greatest extent allowed.

Ilokano Reduplication

The form of reduplication in Ilokano is in fact a **heavy** syllable, not a simple syllable. Hence, /dait/ reduplicates as *da:-da.ʔit* or, in some dialects, *dad-da.ʔit*. See Hayes & Abad 1989.

¹⁰ Refinements on melody copying are explored in section 4.3.

In Orokaiva (Healey, Isoroembo, & Chittleborough 1969), repetitive prefixation interacts in an interesting and typical way with syllabification constraints. These are the relevant data:

(14) Orokaiva Verbal Reduplication

a. waeke	WA-waeke	'shut'
b. hirike	HI-hirike	'open'
c. tiuke	TI-tiuke	'cut'
d. uhuke	U.H-uhuke	'blow'

Healey *et al.* describe reduplication as copying the “first CV or VC of stems’”. The language only allows syllables V, CV, and CVN; the N is homorganic to a following C and disappears word-finally in favor of vowel nasality. Codas, then, must be nasal and can only *share* place-of-articulation specification — they must be ‘linked’ in the sense of Steriade (1982); word-finally a nasal may be extrasyllabic. We interpret the coda requirement in the manner of Itô (1986) as a filter on syllable-final elements:

(15) Coda Condition



Condition (15) asserts that syllable-final consonants may not have a place of articulation (whence the fact that hypothetical word-final nasals are expressed only by vowel nasality); since the Geminate Constraint (Schein & Steriade 1986, Hayes 1986) will prevent it from analyzing a doubly linked place-matrix, blocking its application, it follows that an admissible syllable-final consonant will be place-linked to a following consonant.

The Coda Condition will rule out ever taking the prefix σ to include CVN, since the N will never be linked to the stem-initial consonant, which follows it syllabically.

The behavior of the σ -prefix establishes that the principles of lexical syllabification hold in the prefix+stem domain. An immediate consequence is the special treatment accorded to vowel-initial stems: in the LR sweep mapping phonemes into prosody, the first C of the copied melody finds a place as the onset of the stem-initial syllable.

(16)

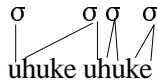

As is perhaps universal in lexical syllabification, a syllable will take an onset whenever it can.

The Orokaiva CV/VC pattern might suggest to the unwary that the prefix is XX, the long-sought-for example of segmental reduplication. As with the XXX affix discussed above, any descriptive success of XX is no more than a freak of the limited prosody at hand. The putative bisegmental affix can hardly be expected to make its appearance in a language where #CC and #VV are found. The σ -affix, on the other hand, is entirely free to occur, with its realizational variants determined by independent considerations. This particular realization — in which an application of the Onset Rule has resulted in apparent ‘extra’ copying — we will see to be of fundamental importance as we look at other languages. It characterizes not only the distribution of XX and its congeners, but also the otherwise inexpressible notion ‘maximal intersyllabic cluster’ and the typology of reduplicative suffixes.

Orokaiva Reduplication

The analysis of Orokaiva reduplication given in the text is unlikely to be correct. The theoretical point — that the template needn't be co-extensive with the observed reduplicant — is made equally well by the Oykangand example, immediately below, and the Mokilese *and-andip* pattern, on p. 16). But in examples like *uhuhuke*, it is almost certainly the case that the reduplicant is **infix**, after an initial onsetless syllable: *u-HU-huke*. This pattern of infixation is also seen in Uradhi, Timugon Murut, as on p. 36, as well as Sanskrit (p. 15) and many other languages. (The question then arises as to how an Oykangand-type analysis of Orokaiva is to be ruled out on principled grounds!) Optimality Theory sheds some light on this infixing pattern; see M&P 1993ab, 1994ab, and the remark on p. 40. On phenomena in Arrernte [“Aranda”] that are similar to those of Oykangand, involving an apparent “VC” unit, see Breen 1990, Henderson (to appear), Turner & Breen 1984, and Wilkins 1984, 1989.

Strikingly similar facts, which bear on the realization issue, are reported for Oykangand in Sommer (1981):¹¹

(17) Reduplication in Oykangand

a. /eder/	ED-eder	‘rain’
b. /algal/	ALG-algal	‘straight’
c. /igu-/	IG-igun	‘go’

Here the σ -affix creates a somewhat richer array of patterns because final consonants are allowed more freely:

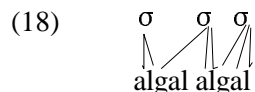

Oykangand words may not begin with consonants. Sommer has taken this to mean that Oykangand **syllables** must — contra naturam — be similarly restricted, at least underlyingly; he cites reduplication as presumptive evidence for the claim, proposing that it copies a ‘syllable’, i.e. VC*. Since such an operation is in all likelihood impossible, rather than merely unusual (as Sommer himself suggests), the reduplication evidence cannot support the syllabic claim. The present theory resolves the issue, providing an analysis which depends only on the universally-expected (and phonetically observable) syllabification of the language.

The evidence reviewed here shows that the ultimate shape of a reduplicated sequence is sensitive in subtle ways to the character of syllabification in a language. When syllabification across the prefix-stem boundary is permitted, as in Orokaiva and Oykangand, an extra consonant will be taken to fill an empty onset position. In Ilokano, by contrast, stem and prefixes form separate syllabification domains, and empty onsets are filled with epenthetic glottal stop: from /ag+σ+adal/, we get [a.gad.ʔadal]. Consequently no σ C-pattern is found. A like pattern, pervading all prefixes, reduplicative and nonreduplicative, is observed in Sundanese (Robins 1959).

¹¹ Sommer cites a pattern of internal reduplication for some polysyllabic stems:

a. /iyalme-/	iy-ALM-almey	‘play’
b. /anajumi-/	anaj-UM-umin	‘peek’

Without a more extensive account of Oykangand phonology and morphology, it's not entirely clear what to make of these examples. They do suggest, however, that prefixation might actually be to the minimal word rather than to the word proper: this would cover all the cases. See below, section 2.3. Sommer also cites the pair /oyelm/ ‘back again’ and *OYEL-oyelm* ‘straight back again’, which he notes is limited to this one word.

ONSET, Templates, & Alignment

The constraint ONSET is fundamental to OT syllable typology (Prince & Smolensky 1993). Through domination of constraints on the form of the reduplicant (that is, templatic constraints), it leads to the kind of “extra” copying seen in Oykangand and other examples below (Mokilese, p. 16, Tzeltal, p. 32, and Chamorro, p. 44). The templatic constraints involved here are those that pertain to the *alignment* of its edges — for instance, in Oykangand, the right edge of the reduplicant is misaligned with a syllable-edge, in *AL.G-algal*. See M&P (1993a: Chapt. 7, 1994ab, 1995a).

THE CORE SYLLABLE AS PREFIX TARGET

The most familiar and well-studied instances of core syllable (σ_c) reduplication are provided by Sanskrit and Greek (Steriade 1982, 1985), but the phenomenon is by no means restricted to Indo-European. Tagalog uses it to mark several morphological categories (Bowen 1969), for example the Recent Perfective:

(19) Core Syllable Reduplication in Tagalog

- | | |
|------------------|-----------------------------|
| a. ka-TA-trabaho | ‘just finished working’ |
| b. ka-I-ipon | ‘just saved’ |
| c. ka-GA-galit | ‘just got mad’ |
| d. ka-BO-bloout | ‘just gave a special treat’ |

Characteristic is the reduction of initial clusters to one element, a result that comes through mapping to σ_c , which tolerates no more than one onset consonant. The normal selection of the first consonant in a cluster, as we have noted, engages the notion of phoneme-driving and the theory of what elements may be skipped.

- (20)
-

The Core Syllable

Steriade 1988, expanding on the claims of the present work, proposes that the simple onset of the core-syllable template is to be related to a syllable-markedness parameter, and she implements this idea with a truncation rule applying to the copied material. In M&P 1993a, 1994ab, 1995a, universal constraints on syllable structure interact, under Optimality Theory, with constraints on exactness of copying, to produce the core-syllable phenomenon as well as other possible unmarked properties of the reduplicant, exactly paralleling the way syllable restrictions are imposed in ordinary (nonreduplicative) phonology. On this ‘Generalized Template’ theory of prosodic morphology, see also Gafos 1995, Rosenthal 1995, Urbanczyk 1995, 1996ab.

The Sanskrit verb reduplicates in 5 of its forms, 4 according to the pattern σ_c : the present, the aorist, the perfect, and the desiderative. In every case the simplification of initial cluster proceeds in the same way: the least sonorous member is preserved. Steriade (1982) is able to derive this with LR mapping on the assumption that onsets are of strictly rising sonority; if copying takes only syllabified material, then extrasyllabic elements such as initial /s/ in *s*-obstruent clusters will not appear on the prefix: thus *tsar* > *TA-tsar*, but *sthaa* > *TA-sthaa*.¹² Choice of vocalism in the prefix varies from category to category, and involves considerable phonological

¹² Alternative accounts are made possible by the present theory. Suppose for example that mapping is not really LR but rather head-to-head on prosodic constituents. Then the head — least sonorous member — of the onset cluster would be chosen, regardless of the extrasyllabicity situation. An account along these lines must assume that the representation analyzed by the prefix contains prosodic information.

complexity irrelevant to present concerns (v. Steriade (1985) for discussion). However, the behavior of vowel-initial roots is of some interest. They appear to be poorly represented in all categories except the perfect, where the following rules hold (Whitney 1889, section 783):

(21) Perfect Reduplication in Sanskrit V-initial Roots

- | | | | |
|----|---|---|----------------|
| a. | $\sigma_c + \sqrt{a}C$ | $\rightarrow a+aC > a:C$ | |
| b. | $\sigma_c + \sqrt{i}C$ | $\rightarrow i+iC > i:C$ | (weak grade) |
| | | $\rightarrow i+aiC > iyaiC \Rightarrow iye:C$ | (strong grade) |
| c. | $\sigma_c + \sqrt{u}C$ | $\rightarrow u+uC > u:C$ | (weak grade) |
| | | $\rightarrow u+auC > uvauC \Rightarrow uvo:C$ | (strong grade) |
| d. | \sqrt{VCC}, \sqrt{VVC} do not usually form reduplicated perfects. | | |

Since the postvocalic C is not taken as an onset, as it is in Orokaiva and Oykangand, we must conclude that syllabification is not allowed across the prefix-root boundary, at least at the relevant level of the lexical phonology. Evidence that this is true comes from the behavior of the high-vowel roots (21b,c). Steriade (1985) points out that ‘the general rule of Glide Formation fails to apply to such forms: intermediate *u-áuca* does not become *váuca*, surface **voca*.’ She offers an account in terms of rule ordering and the Strict Cycle. But if Glide Formation is a process of filling an empty onset, then it cannot apply across a boundary that is a barrier to onset formation. The surface forms are derived as in Steriade’s analysis, by the application of postcyclic Glide Insertion and vowel fusion (Whitney, section 126).

Most of the relatively small number of vowel initial forms attested from outside the categories (21a,b,c) show a remarkable variation on the normal pattern:

(22) Other V-Initial Forms in Sanskrit

- | | | | |
|----|---------------------|---------------------------|--------|
| a. | \sqrt{iir} | iir-IR-é | (pf.) |
| b. | \sqrt{am} | aam-AM-at ¹³ | (aor.) |
| c. | \sqrt{aap} | aap-IP-an | (aor.) |
| d. | \sqrt{arp} | arp-IP-am | (aor.) |
| e. | \sqrt{edh} | ed-IDH-isa | (des.) |
| f. | $\sqrt{a\check{c}}$ | a\check{c}-I\check{c}-isa | (des.) |

Although the form *aamamat* (a+am-am+at) suggests syllabification into the prefix, the other forms are inconsistent with this. The vocalism in (22c,d,f), with /a/ reduplicating as /i/, is normal for aorist and desiderative; cf. aor. *a+ti-tras+am*, des. *bi-badh+isa* (Whitney, sections 858, 1029). Furthermore, it is always the second instance of the root which is segmentally reduced, as in *arp-IP+am*. What additional data is available from grammatical sources follows this pattern without exception:

¹³ Lengthening of the initial vowel is due to the ‘temporal augment’ /a+/.

(23) V-initial Aorist and Desiderative Forms

a. Aorists:

√arc	aarc-IC+am
√ubj	aaubj-IJ+am ¹⁴
√arh	aarj-IH+am
√rdh	aard-IDH+am
√iiks	aaic-IKS+am.

b. Desideratives:

√arh	arj-IH+isa
√und	und-ID+isa
√rdh	ard-IDH+isa

We conclude that vowel-initial roots do indeed use suffixation. In addition, the pattern of losses indicates that the suffix can only be σ_c , with cross-boundary syllabifications.

Sanskrit Vowel-Initial Reduplication

As noted in Kiparsky 1986, the pattern in the aorist is *infixation*, not suffixation, as incorrectly claimed here. E.g. *ar-PI-pam*, not *arp-IP-am*. In M&P 1993a, the various reduplicative peculiarities of Sanskrit vowel-initial roots result from the force of the constraint ONSET. This relates aspects of Sanskrit reduplication to Orokaiva above (p. 11) and Timugon Murut etc. below (p. 36).

Melody copying and association are incoherent with a σ_c suffix; see sections 2.2 and 4 for discussion. The suffix is therefore satisfied by spreading, as in Steriade's (1982) analysis of Greek. Consider the linking process that creates *arpipam*:

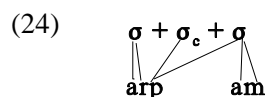

If copying were involved rather than spreading, the vowel could be copied as *a* and turned into *i* by a rule associated with reduplication of aorist, desiderative, and (sometimes) present. The desiderative *undidisa* from √und permits no such account, since *u* never reduplicates as *i*; such forms are explicable only if the suffix's vowel has been fixed at *i*. The aorist *aaubjIJam* (/a+ubj+ σ_c +am/) from √ubj is a similar case.¹⁵ The vowel *i* is therefore inserted, evidently by default specification, and the filling of then open syllabic positions comes about through spreading rather than copying, in much the same way as Steriade (1982) has proposed for Greek prefixing reduplication.

Roots with final clusters of falling sonority behave in the same way:

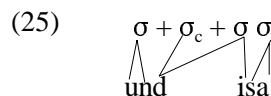

The one case where *infixing* occurs (*aaikIKSam* from √iiks) follows smoothly, given Steriade's theory of Sanskrit syllabification by which the rising sonority of *ks-* suffices to license it as an onset:

¹⁴ The long initial diphthong *aaui* is a regular consequence of adding the augment *a-* to vowel-initial roots (Whitney, 136a) and has nothing to do with the peculiarities of the reduplicating subclass of aorists.

¹⁵ The aorist evidence is less clearcut since the syllabic incorporation of the augment *a-* into the erswhile root syllable provides a source for *i*, if it can be copied (this being a rather familiar way that syllabification muddles morpheme boundaries).

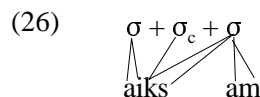

The proposed analysis depends crucially on the assumption that the final suffix (the one after the reduplicant σ_c) begins with a vowel, opening up an onset position. This is in fact the case for both aorist and desiderative.

The reduplicating aorist shows an interesting divergence from the simple σ_c form: it ‘aims always at establishing a diversity between the reduplicating and radical syllables, making the one heavy and the other light (Whitney, section 858b)’. There are three general rules:

(27) Prefix/Stem Complementarity

- a. If the root is light (CVC, since all aorist suffixes are vowel initial), the prefix vowel is lengthened; thus $\sqrt{\text{ris}}$ gives *a+RII-ri.s+am*.
- b. If the root begins with a cluster, the prefix is already heavy and nothing happens: $\sqrt{\text{krudh}}$ gives *a+KU-k.ru.dh+am*.
- c. If the root is heavy, the prefix remains light: $\sqrt{\text{diks}}$ gives *a+DI-dik.s+am*.

Evidently there is a rule making the prefix syllable heavy — inserting a mora — before a light stem syllable.¹⁶ The rule cannot apply if the stem syllable already has the full complement of 2 moras. By familiar processes (Ingria 1980), the prefix vowel spreads automatically to fill the empty mora position. Notice that the designation σ_c governs only the initial mapping process, creating a σ which is as liable to phonological manipulation as any other.¹⁷

THE HEAVY SYLLABLE AS PREFIX TARGET

Mokilese

Mokilese reduplication has been insightfully analyzed by Levin (1983, 1985) within the segmental framework. We argue here that the affix shape invariant must be construed prosodically.

The progressive aspect of the Mokilese verb is formed by prefixation of a heavy syllable target, as can be seen from the following data provided by Harrison & Albert (1976), who explicitly note the generalization:

(28) Reduplication in Mokilese, /CVC.../ Stems

pɔdɔk	pɔd-pɔdɔk	‘plant’
m ^w iŋe	m ^w iŋ-m ^w iŋe	‘eat’
kasɔ	kas-kasɔ	‘throw’
wadek	wad-wadek	‘read’
pilɔd	pil-pilɔd	‘pick breadfruit’
dɔp ^w ɔ	dɔp ^w -dɔp ^w ɔ	‘pull’
poki	pok-poki	‘beat’

¹⁶ The same rule applies in the intensive (section 1002.III.f) in the older language. Discussion of the poorly attested intensive, which involves a number of interesting descriptive problems (v. Steriade 1985), will be postponed to a later version of this work.

¹⁷ Quantitative complementarity should probably be understood in terms of higher-order prosodic structuring. Suppose that the actual rule is to impose an asymmetrical (iambic) foot LR. This is always possible, because the aorist prefix *a-* necessarily forms a light syllable. If the root syllable is heavy, a clash would result: this typically blocks the process. Interestingly, there are cases where the root syllable is lightened (section 861) to accommodate the iambic pattern; thus $\sqrt{\text{raadh}}$ gives *a-RAA-radham*, $\sqrt{\text{krand}}$ gives *a-CIk.rad.am*. This equivocation is familiar from other clash-driven processes: when there are several solutions, variability is likely. Quantitative complementarity also shows up in Ponapean (v. inf.) and in most cases of counting allomorphy rules (section 1), with strong indications of a similar but not identical prosodic basis.

(29) Reduplication in Mokilese, /CV/ and /CV.V.../ Stems

pa	paa-pa	‘weave’
wi.a	wii-wi.a	‘do’
di.ar	dii-di.ar	‘find’

(30) Reduplication in Mokilese, /CV:.../ Stems

kookɔ	koo-kookɔ	‘grind coconut’
sɔɔrɔk	sɔɔ-sɔɔrɔk	‘tear’
čaa	čaa-čaa	‘bend’

The examples in (28) show the target $\sigma_{\mu\mu}$ being satisfied by an initial substring of melodic elements.

In (29) association from the copy must fail to satisfy the target. Examples like /pa/ simply lack the stuff to fill out a heavy syllable by 1:1 mapping; and since the vowel sequences of the other two examples are always heterosyllabic, a form like *di.ar* can only link *di*, never *dia*, to a syllabic prefix. (As noted above, the mapping must stop with the failure of *a* to link, so that *dir-di.ar* is not a possible outcome.) The single successfully linked vowel must therefore be spread to fill the 2nd mora position.

The examples of (30) show that a long vowel is copied as long — a phenomenon dubbed ‘transfer’ in Clements (1985a), which obviously requires some refinement of the mapping procedure. We consider techniques for dealing with it in section 4.3.

Quantitative Transfer

This phenomenon and its significance were first noted by Levin 1983. An account of it is given in M&P 1988. Other relevant work includes Hammond 1988, Steriade 1988, and Selkirk 1988. For recent work on Mokilese reduplication, see Blevins 1996.

A search of the dictionary reveals that superheavy CVVC syllables are found only at word-end, presumably because of the availability of consonant extrametricality there. The two mora requirement imposed by the prefix is therefore satisfied maximally by CVV: whence *sɔɔ-sɔɔrɔk*, never **sɔɔr-sɔɔrɔk*.

A third pattern generating long vowels is observed in (31), where CVG-initial stems give a CVV prefix.

(31) Reduplication in Mokilese, Diphthongal Stems

pou.ce	poo-pouce	‘connect’
dau.li	daa-dauli	‘pass by’
au.do	aa-audo	‘fill’

Mokilese has a general rule of diphthong formation, summarized as follows by Harrison & Albert: ‘a high vowel becomes a glide after a lower vowel and before a consonant or at the end of a word.’ (This is not fully accurate—their own example is *ka+onopda* → *kɔwnopda* ‘cause+prepared= to prepare’.) All instances of [y] are derivable; [w] is arguable phonemic in only a few words (p. 32). This suggests an analysis in which the basic syllabification is *po.u.ce*, *da.u.li*, *a.u.do*, paralleling *wi.a*, *di.ar* in (29), giving rise to exactly the same pattern of association. Interestingly, some speakers allow CVG reduplication, with *audo* > *au-audo*, showing that for them diphthongal nuclei are at least possible in the basic syllabification.

The behavior of the CV.V-initial stems in (29) and (31) demonstrates clearly that the prefix cannot be XXX, pure segmentalia, but must include the information that the result in these cases must be a licit single syllable of the language.

Of particular interest— as usual — is the behavior of vowel-initial stems.

(32) Reduplication in Mokilese, V-initial Stems

a. ir	ir-r-ir	‘string’
b. onop	on-n-op	‘prepare’
c. idip	id-d-idip	
d. alu	al-l-alu	‘walk’
e. uruur	ur-r-uruur	‘laugh’
f. andip	an-d-andip	‘spit’

Form (32f) shows the syllabification effect we’ve seen before: both the prefix $\sigma_{\mu\mu}$ and the stem-initial onset are satisfied from the copied melody:¹⁸

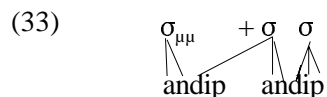

In cases where there is no separate consonant for the stem onset, the moraic consonant spreads to fill it. This can be best understood in relation to a process Harrison & Albert call ‘Boundary Lengthening’. Before ‘loosely-bound’ suffixes the following changes take place:

(34) Boundary Lengthening

a. Before a V-initial suffix, a single final consonant is geminated:

did # e → didde ‘this wall’

puk # ɔr → pukkɔr ‘only books’

b. Before a C-initial suffix, final vowels are lengthened.

indi # la → indiila ‘go-down and away’

si # pas → siipas ‘a bone’

pina # ki # di → pinaakiidi ‘cover with’

This class of suffixes adds a mora to a preceding syllable, as is clear from (34b). Associated with the process is a rule spreading the stem-final C (construed melodically) into the empty onset position of V-initial (ditto) suffixes, which we display in (35):

(35) Onset Filling



This is, of course, exactly the rule evidenced in the reduplicated prefixes (32a-e).

A further generalization is possible. If the reduplicative prefix is included in the class of ‘loosely-bound’ affixes, it is no longer necessary to specify that the prefix is bimoraic: this follows from the general pattern of boundary lengthening. The prefix, then, is plausibly interpreted as a kind of clitic, prefixation as a kind of (near-) compounding. The actual progressive prefix then reduces to the familiar σ , with its prosodic properties following from its morphological affinities.

¹⁸ Harrison & Albert claim that this effect is only observed with NC clusters, but they cite no evidence to support the restriction. The alternative we would conceivably find in other clusters is *appapta* from hypothetical *apta*.

Ponapean: Heavy and Light σ as Prefixes

Ponapean, a Micronesian language closely related to Mokilese, uses a richly varied pattern of reduplications to mark the durative in verbs. It has been analyzed in Rehg & Sohl (1981), the source of all data, in Levin (1985) from the segmentalist point of view, and in McCarthy (1984a), where fundamental elements of prosodic conditioning in the system are recognized and treated. We examine it afresh not only because it provides instances of $\sigma_{\mu\mu}$ and σ_{μ} as prefix targets, but also because it illustrates how higher order categories, F in particular, can determine affixal prosody.

More on Ponapean

More recent work on Ponapean phonology and morphology includes Goodman 1995, Itô 1989, M&P 1991ab.

As elsewhere, the empty onset provokes special treatment; we will focus first on the more perspicuous behavior of C-initial stems.

Ponapean I: Consonant-initial Stems

With monosyllables, the reduplicative prefix takes the form σ_{μ} or $\sigma_{\mu\mu}$ in quantitative complementarity with the base:

(36)	Light base - $\sigma_{\mu\mu}$ prefix	
a.	pa	PAA-pa 'weave'
b.	mi	MII-mi 'exist'
c.	pu	PUU-pu 'bent, crooked'
d.	lo	LOO-lo 'be caught'
d.	lal	LAL-lal 'make a sound'
e.	rer	RER-rer 'tremble'
f.	mem	MEM-mem 'sweet'
g.	kaŋ	KAŋ-kaŋ 'eat'
h.	pap	PAM-pap 'swim'
i.	dod	DON-dod 'frequent'
j.	dil	DIN-dil 'penetrate'
k.	kik	Kiŋ-kik 'kick'
l.	p ^w il	P ^w IL-i-p ^w il 'flow'
m.	par	PAR-a-par 'to cut'
n.	tep	TEP-e-tep 'kick'
o.	tep	TEP-i-tep 'begin'

Some phonology is visible here. At the surface, nonfinal syllables can close only on geminates or assimilated nasals. A variety of assimilation rules at various strata of the grammar respond to this restriction; see Rehg & Sohl (1981, pp. 56-64), McCarthy (1984a), Itô (1986) for discussion. When there is no assimilation, impermissible clusters such as those in (l-o) are broken up with vowels. It is important to note that the process

of cluster break-up is not limited (as some assimilations are) to reduplicated structures.¹⁹ We therefore abstract away from the Epenthesis process in identifying the prefix as syllabic.

(37)	Heavy base - σ_μ pref. _{IX}	
a.	duup	DU-duup ‘dive’
b.	miik	MI-miik ‘suck’
c.	m ^w aaw	M ^w A-m ^w aaw ‘good’
d.	laud	LA-laud ‘big, old’
e.	reid	RE-reid ‘stain’
f.	pou	PO-pou ‘cold’
g.	pei	PE-pei ‘fight’
h.	mand	MA-mand ‘tame’
i.	leŋk	LE-leŋk ‘acrophobic’
j.	kens	KE-kens ‘ulcerate’

The light base is CVC; the heavy base CVV, CVCC, or CVVC. This contrast is reconciled with the familiar light-heavy distinction (CV vs. CVX) if final consonants are extrametrical. McCarthy (1984a) adduces independent evidence in support of this claim. Nouns are subject to a min Wd requirement demanding two moras at the surface. When they are underlyingly CV or CVC, they are vowel-lengthened to CVV and CVVC (respectively). Forms CVV, CVCC, and CVVC are untouched. Extrametricality puts the CVC forms in the monomoraic class and further predicts that only the (intrametrical) vowel is available for satisfying the obligatory second mora.

Jane Grimshaw suggests that quantitative complementarity be viewed as the consequence of a requirement on higher-order structure to the effect that a reduplicated monosyllable contain no more than a single foot. Although the stress system of Ponapean is not discussed in Rehg & Sohl (1981), it is fair to assume that any quantity-sensitive prosody will tolerate at most one heavy syllable per foot. We further assume that F is minimally bimoraic: this allows us to interpret the Noun minWd requirement in the usual way as minWd = F. We can take the prefix to be σ , unspecified for weight, which will satisfy itself maximally up to the foot limitation, recorded here:

¹⁹ Rehg & Sohl distinguish 4 types of vowel insertion.

<1> Prothesis of *i/u*, providing a vocalic nucleus to supplant a syllabic nasal. Thus, *m.pe* ‘beside it’ may be pronounced *im.pe*. Choice between *i* and *u* is phonetically predictable. (p. 55-6)

<2> Copying of the following vowel, whereby *ak+dei* → *ak-e-dei*, *ak+tantat* → *ak-a-tantat*. Various conditions obtain (p.92-94).

<3> General Epenthesis of *i/u*, with choice determined as in <1>, to break up any impermissible cluster not otherwise dealt with. “In slow, careful speech they are less likely to be employed than in rapid, less careful speech.” (p. 94)

<4> Appearance of ‘base vowel’ (p.87-91). Of great interest to the present argument is the preservation of some etymological final vowels in suffixation and in reduplication of monosyllabic roots. With the verbalizing suffix *-niki* ‘to have the thing characterized by the base’, we find, for example:

i.	kiil	‘skin’	kil-i-niki
ii.	ŋjiil	‘voice’	ŋjil-e-niki
iii.	diip	‘sin’	dip-a-niki

According to Rehg & Sohl, it is the base vowel that breaks up the cluster in (361-o), accounting for the phonologically inexplicable difference between *tep-e-tep* ‘kick’ and *tep-i-tep* ‘begin’ — cf. transitives *tepek* ‘kick’ and *tapi* ‘begin’. Given the plethora of insertions in the language, it’s not at all clear that the cited data unambiguously establishes the claim. Supposing however that it is correct, are we driven to the etymologizing conclusion that reduplication is bisyllabic (= F), with various subsequent reductions? We think not. With McCarthy (1984a) we propose that the ‘base vowel’ is a kind of floating affixal melodeme associated with certain roots, which is allowed to surface when a free vowel slot presents itself. In support of this, we note that there are only 3 types of base vowel /i a e/, out of a 7 vowel system, a typical grammaticalization of opaque phonology. The reader is referred to Harris (1985) for discussion of a rather similar phenomenon in Spanish, and to Itô (1986) for analysis of the assimilation/epenthesis system in Ponapean.

(38) *Monosyllable/Monostress Rule* (Grimshaw).

Reduplicated monosyllables contain one and only one F.

If feet are strictly iambic then a form like *mem* meets (38) by containing one F and one loose syllable: [*mem*]me(m). If asymmetrical trochaic feet can be derived, then it ends up as a single tidy foot. Stems like *mand*, of course, reduplicate as perfect iambs: *maman*(d).

Polysyllables also choose between σ_{μ} and $\sigma_{\mu\mu}$, but the grounds for choice are, on the face of things, remarkable. First, the mundane: when the initial syllable is light, the prefix is $\sigma_{\mu\mu}$:

(39) Polysyllabic Stem - light initial syllable

a. rere	RER-rere	‘to skin or peel’
b. dune	DUN-dune	‘attach in a sequence’
c. deyed	DEY-deyed	‘eat breakfast’
d. dilip	DIN-dilip	‘mend thatch’
e. pepe	PEM-pepe	‘swim to’
f. sarek	SAN-sarek	‘uproot’
g. siped	SIP-i-siped	‘shake out’
h. taman	TAM-a-taman	‘remember’
i. tepek	TEP-e-tepek	‘kick’
j. lɔŋe	Lɔŋ-(i)-lɔŋe	‘pass across’
k. katoore	KAT-(i)-katoore	‘subtract’
l. li.aan	LII-li.aan	‘outgoing’
m. ri.aala	RII-ri.aala	‘be cursed’
n. lu.ak	LUU-lu.ak	‘jealous’
o. lu.et	LUU-lu.et	‘weak’

Phonological notes: Forms (d-f) show the typical assimilations. Forms (g-k) show insertion into unassimilable clusters: those in (j,k) are optional and characteristic of casual speech; those in (g-i) are obligatory and copy the *following* vowel, as can be seen by application of the rule elsewhere.²⁰ As above, we abstract away from predictable epenthesis to reveal the uniformly syllabic character of the prefix. Forms (l-o) show automatic spreading of the vowel to fill the required second mora. Since vowel sequences like *i.a* and *u.a* are necessarily heterosyllabic, they can’t be mapped into the prefix σ and the mapping must stop with the stem’s first vowel melodeme. (As we have seen before, it is universally impossible to skip over the unassociated vowel to seize on a following consonant: **lin-liaan*.)

Complementarity makes its appearance when the first syllable is heavy,²¹ but surprisingly does not respond to the first syllable at all: the **second** syllable’s weight determines the weight of the prefix.

²⁰ Rehg & Sohl cite the following paradigm:

i.	/ak+dei/	akedei
ii.	/ak+p ^w uŋ/	akup ^w uŋ
iii.	/ak+tantat/	akatantat

For discussion of conditions under which a copy vowel appears, see Rehg & Sohl (1981, p.92-94).

²¹ Rehg & Sohl say more particularly that the first syllable must contain a long vowel, but they cite no evidence to support a distinction between CVV and CVC.

- (40) σ_{μ} with Heavy 2nd Syllable
- | | | |
|---------------------------------------|---------------------------------------|-------------------------|
| a. luum ^w uum ^w | LU-luum ^w uum ^w | ‘be sick’ |
| b. maasaas | MA-maasaas | ‘cleared of vegetation’ |
| c. tooroor | TO-tooroor | ‘be independent’ |
| d. waantuuke | WA-waantuuke | ‘count’ |
- (41) $\sigma_{\mu\mu}$ with Light 2nd syllable²²
- | | | |
|-----------|------------|-----------------|
| a. duupek | DUU-duupek | ‘starved’ |
| b. meelel | MEE-meelel | ‘true’ |
| c. nOOrök | NOO-nOOrök | ‘greedy’ |
| d. peese | PEE-peese | ‘be acquainted’ |

Viewed in terms of the sequential structure of the syllable string, the rule of complementarity is mysterious indeed: not only is it nonlocal, but it skips over an entity ($\sigma_{\mu\mu}$) of exactly the same type that it’s looking for.

The prosodic effect is however uniform and simple: the output contains exactly two feet. We therefore adopt for polysyllables a foot-condition analogous to that imposed on monosyllables:

(42) *Polysyllable/Two Stress Rule.*

Reduplicated polysyllables must have exactly 2 feet.

If there are two heavy syllables in the stem, as in (40), the prefix must shrink to σ_{μ} to avoid running over the 2F limit: thus $[maa][saas] \rightarrow [mamaa][saas]$. With only one heavy syllable in the stem, as in (41), the prefix σ is free to expand maximally, indeed must do so: whence $[duupek] \rightarrow [duu][duupek]$.

Notice that the Polysyllable Rule applies equally to well to the forms of (39); all are monopod bases, so that the FF target can only be achieved via $\sigma_{\mu\mu}$ -prefixation: thus from $[dune]$ we get $[dun][dune]$.

What we have here is a kind of templatic morphology superimposed on the reduplication process. The prefix is always σ , but monosyllable stems satisfy a template F, polysyllables a template FF. The templates impose weight requirements on the prefix and mediate the transmission of just that kind of nonlocal information which affects the foot structure of the word.

There is one final class of C-initial polysyllable to consider: those beginning with a syllabic nasal. They reduplicate exactly as expected, given the associated phonology. (Syllabic nasals capitalized in the examples.)

- (43) Syllabic Nasals
- | | | |
|--------------------------------------|---|-------------------|
| a. M.med | M.m-i-m.med | ‘full’ |
| b. ŋ.ŋar | N.ŋ-i-ŋ.ŋar | ‘see’ |
| c. M ^w .m ^w us | M ^w .m ^w -u-m ^w .m ^w us | ‘vomit’ |
| d. M.pek | M.p-i-m.pek | ‘search for lice’ |
| e. N.da | N.d-i-n.da | ‘say’ |
| f. M ^w .p ^w ul | M ^w .p ^w -u-m ^w .p ^w ul | ‘to flame’ |

Syllabic nasals are only allowed word-initially, preceding a consonant to which they are homorganic. Even there they are liable to degemination in forms like (a-c) (p.36) and in forms like (d-f) they show optional prothesis of /i/ or /u/, the latter appearing with rounded initial consonants or when the vowel of the first syllable is round (p.56). Rendered word-internal by morphology, the nasals must desyllabify: for example, $ka+mmed$ ‘cause to be full’ emerges as bisyllabic $kam.med$. Epenthesis of i/u is therefore internally obligatory.

²² Note here the transfer of vowel length. See below, section 4 for discussion. The $\sigma_{\mu\mu}$ prefix cannot extend itself all the way to CVVC ($*duup-duupek$) because superheavy syllables are allowed only word-finally. Compounds, of course, consist of two words: e.g. (40d) $waantuuke$ ‘count’.

Putting all this together, we see that a form like *M.pek* reduplicates like e.g. *dune* (39b). As a polysyllable, it must satisfy a template FF; therefore σ expands as $\sigma_{\mu\mu}$, *Mp*. The derived form *Mp-M.pek* undergoes the general rule of epenthesis, emerging as *M.pim.pek*.²³

Ponapean II: Vowel-Initial Stems

The single essential peculiarity of vowel-initial stems is that a vocalic element of one sort or another appears between the expected σ -satisfying prefix and the stem:

(44) Reduplication of Vowel-initial Stems

a. el	el- <i>e</i> -el	‘rub, massage’
b. uk	uk- <i>u</i> -uk	‘fast’
c. it	it- <i>i</i> -it	‘stuffed’
d. aan	a- <i>y</i> -aan	‘be accustomed to’
e. oon	o- <i>y</i> -oon	‘hung over’
f. eed	e- <i>y</i> -eed	‘strip off’
g. iik	i- <i>y</i> -iik	‘inhale’
h. uuk	u- <i>y</i> -uuk	‘lead’
i. uutoor	uu- <i>y</i> -uutoor	‘independent’
j. alu	al- <i>i</i> -alu	‘walk’
k. inen	in- <i>i</i> -inen	‘straight’
l. urak	ur- <i>u</i> -urak	‘wade’

Except for (44j) *uu-y-uutoor*, which should parallel (40c) *to-tooroor*, the general rules for choosing between σ_{μ} and $\sigma_{\mu\mu}$ are clearly in effect: the heavy monosyllables of (d-h) get the σ_{μ} prefix; the others, $\sigma_{\mu\mu}$.

Mokilese resolves the empty onset problem by spreading the syllable-final C: Mok. *alu* ‘walk’ becomes *al-l-alu*. Ponapean responds to the structural pressure in a different way: the empty stem-initial onset is filled, we propose, with a glide /y/. Intervocally, as in (d-i), that’s exactly what we see. But glides are disallowed post-consonantly. Therefore they vocalize, presumably via a rule which adjoins the preceding consonant, whereupon they will assimilate in quality to any following high vowel and to any vowel in monosyllables.²⁴ By this account, Ponapean *alu* goes to *al-y-alu*, surfacing as *a.li.a.lu*, while *el* ‘rub’ goes to *el-y-el*, surfacing as *e.leel*.

There is some variation in the high-vowel class of heavy monosyllables: *iik* may reduplicate as *ik-iik*, *uuk* as *uk-uuk*. Rehg & Sohl note a possible source in analogy with *uk* (b) and *it* (c). Formally, we can get this by exceptionally blocking glide insertion and allowing the stem-initial onset to pick the copy’s final consonant, as in Orokaiva and others above. Another reported variant is *uwuuk* for *uyuuk*, presumably due to allowing the language’s general glide insertion process to operate in the reduplication environment.

One small class remains, which lies outside the general pattern discussed here: glide-initial light monosyllables, which reduplicate with a fixed prefix *Ge-*.

(45) Reduplication of Glide-initial Stems

a. wa	we-wa	‘carry’
b. was	we-was	‘obnoxious’
c. yang	ye-yang	‘accompany’

²³ Another possible line of analysis would be to hold that syllabic nasals arise by optional dropping of initial *i/u*. Then *impek* exactly resembles Mokilese *andip*.

²⁴ Rehg & Sohl report some optionality in what appears to be the nonhigh vowel class: thus *amas* reduplicates as either *amiamas* or *amaamas*, *ewetik* as either *ewiewetik* or *eweewetik*.

It's possible to imagine a story assimilating these to the vowel-initial class, whereby the inserted *y* vocalizes and dissimilates to *e* — so that *ua* > *u-y-ua* > *u-e-ua*. But it hardly seems worth it,²⁵ especially since the pattern is being lost from the language in favor of treating the forms as consonant-initial.

Ponapean III: Conclusion

Ponapean demonstrates quite unambiguously the fully prosodic character of reduplication. The categories foot, syllable, and mora interact to characterize the reduplicating prefix in a quite general way. Even the (typically quirky) onsetless stems fit into the core system with a minimum of special handling.

Ponapean IV: Proleptic and Historical Note

The survival of the 'base vowel' in the reduplication of a small class of (currently) monosyllabic stems indicates that the process was originally one of foot reduplication, where $F = \mu \mu$, subsequently subject to a variety of reductions particular to the reduplication structure. (A similar remark can be made for Mokilese.) It is clearly possible to mount a synchronic description based on this premise. We resist the temptation on the grounds that the bulk of the reductions follow immediately from specifying the prefix target as σ (σ_μ , $\sigma_{\mu\mu}$). Independent rules of the language defining syllable and mora tell us what to take and when to amplify by insertion. Furthermore, the principles (38) and (42) assigning foot templates to mono- and polysyllabic bases determine the form of the prefix σ in an entirely straightforward way, resolving the otherwise inscrutable issue of quantitative complementarity — if we take the prefix to be σ . These considerations suggest strongly that the system has in fact been reanalyzed along the lines suggested here.

MINIMAL WORD/FOOT AS PREFIX

A particularly clear illustration of the interaction between reduplication and prosodic constituency is provided by the Australian language Diyari, described by Austin (1981). We will discuss below another Australian system, which involves interesting variations on the same pattern.

Diyari has both CV and CVC syllables, with no vowel length contrast. Consonants are prohibited at the end of a phonological word. Within a root, stress is assigned to each odd-numbered nonfinal syllable, counting from the left (this is a typical pattern in Australian languages);²⁶ thus, the foot is of the trochaic, non-quantity-sensitive type which must branch (whence the absence of stress on final syllables). All phonological words of Diyari contain at least two syllables.²⁷ It follows, then, that the minimal phonological word of Diyari is just a single foot, which we know independently to be disyllabic. Diyari prosody is indifferent to the subsyllabic moraic structure (that is, σ is $a \mu$).

Diyari reduplication is of the type most commonly found in Australia, a prefixed copy of CV(C)CV:

(46) Diyari Reduplication

wiḷa	wiḷa-wiḷa	'woman'
kanku	kanku-kanku	'boy'
ku[kuṅa	ku[ku-ku[kuṅa	'to jump'
t'ilparku	t'ilpa-t'ilparku	'bird sp.'
ṅankaṅṅi	ṅanka-naṅkaṅṅi	'catfish'

Consider what we must explain about this pattern of reduplication. The reduplicated sequence is exactly two syllables, of which the first may be CV or CVC, while the second is CV. From our observations about Diyari prosody, we conclude that the reduplicative affix in this language is just the minimal phonological word, W_{\min} .

²⁵ Notice that among other peculiarities *ua* would have to be treated as heavy monosyllable to get the σ_μ prefix.

²⁶ For discussion of some irrelevant complications in Diyari stress assignment, see Poser (1986).

²⁷ All grammatical words of Diyari also contain at least two syllables, except for the particle *ya* 'and'.

Everything follows from this. We must reduplicate two syllables, because the minimal phonological word is a trochaic foot. The second syllable of the reduplication must be open, because it immediately precedes a phonological word juncture.

In effect what we are saying is that reduplicated forms in Diyari are word-level compounds of an F (= Wd_{\min}) template with a normal word. This is confirmed by Austin's (1981) careful arguments demonstrating that the reduplicated string forms a separate phonological word from the base. Each portion of a reduplicated string takes a separate main word stress (*dúnkadúnka* 'to emerge'), and the vocalic allophony in the stressed syllable of the reduplication as well as the prestopping of intervocalic nasals after the stress confirm this. It follows, then, that the reduplicative affix in Diyari is the minimal free base for word-level compounding.

Diyari Reduplication

The original proposal that Diyari reduplication is foot-based is due to Poser 1982. The analysis was subsequently revised and published as Poser 1989. In the text, we argue that the Diyari reduplicative template is to be identified as the **minimal word** of the language. In M&P 1994a we show that the special status of the *minimal* word as template follows, under Optimality Theory, from its being the most harmonic prosodic word possible with respect to constraints on metrical parsing. Background for this claim includes Spring 1990a, where the general PrWd is argued to play a templatic function, and Itô & Mester 1992, where differing notions of minimality are derived by placing branching constraints on PrWd; see Itô, Kitagawa, & Mester 1996 for development of these in term of Alignment.

In M&P 1994b the argument is taken one step further: we argue that PrWd itself enters as the canonical prosodic realization of the *morphological* category **stem**. Diyari reduplication is therefore stem-compounding, and the behavior of the Diyari reduplicant follows from the identification of its lexical status as *stem*. No prosodic template is required. This then leads to the Generalized Prosodic Morphology Hypothesis: that templatic conditions are the reflection of canonical prosodic restrictions on the morphological category that an item (such as a reduplicative morpheme) belongs to, categories like *stem* and *affix*. These restrictions are imposed by the standard constraints on prosodic structure and morphology-prosody alignment, universal under OT, which dominate the faithfulness constraints relevant to the item's realization. There are no reduplication-specific structural constraints — 'templates'. This seems like the minimal theory one could hold, since morphemes must be assigned to some category (affix, stem,...).

A similar example, but one in which the evidence for minimum word size is of an even more striking character, is provided by the Australian language Lardil. All information on Lardil comes from Hale (1973), Klokeid (1976), and Hale's unpublished field notes and dictionary. Our discussion of Lardil closely follows the insightful treatment of Lardil phonology in Wilkinson (1986).

Lardil Phonology

Wilkinson 1986 was published, in revised and truncated form, as Wilkinson 1988. Prince & Smolensky 1993, chapter 7, show how (the bulk of) Lardil nominal phonology follows from the interaction of constraints, almost all of which are clearly universal in character.

Lardil syllables are of the form CV(V)(C), but there are quite rigid restrictions on final consonants. Only apicals and palatoalveolars are licensed syllable finally.²⁸ As is characteristic of Australian languages, only vowels count as morae, and stress is assigned by a trochaic foot.

Lardil actively enforces a minimum word size requirement of two morae (that is, one foot). Words containing only one mora must be augmented by the suffixation of a morphologically empty *a*:

(47) Augmentation in Lardil

	Underlying	Uninflected	Accusative	
a.	/peer/	peer	peerin	‘ti-tree sp.’
	/maan/	maan	maanin	‘spear gen.’
b.	/parŋa/	parŋa	parŋan	‘stone’
	/kela/	kela	kelan	‘beach’
c.	/wik/	wika	wikin	‘shade’
	/wun/	wunta	wunin	‘rain’

The nouns in (47a) are monosyllabic but bimoriac, while those in (47b) are disyllabic and bimoraic. In these two types, no augmentation occurs in the uninflected form. The nouns in (47c) are underlyingly monomoraic, since they contain only a single short vowel. In the uninflected form, they must undergo augmentation to meet the minimum word-size requirement of two morae.

This requirement functions in another way as well. Words that are three or more morae long undergo truncation of any final vowel:

(48) Truncation in Lardil

/yiliyili/	yiliyil	yiliyilin	‘oyster’
/yukarpa/	yukar	yukarpan	‘husband’

The fact that shorter nouns like those in (47a) do not undergo this truncation follows directly from the minimum word-size requirement — no truncation is possible without reducing such nouns below the minimum size. (V. the Estonian parallel in section 1.)

Lardil has at least two types of reduplication, nominal and verbal. Nominal reduplication, as in many cognate languages, is frozen but nevertheless clearly discernible as reduplication. It generally copies two morae: /muŋkumuŋku/ ‘wooden axe’, /karikari/ ‘butterfish’. Verbal reduplication, a phenomenon whose existence and properties were first noted by Wilkinson, is a more productive morphological process with a discernible iterative meaning:

(49) Reduplication in Lardil

	Simple	Reduplicated	
/keleth/	kele	kelekele	‘cut’
/kelith/	keli	kelikeli	‘jump’
/parelith/	pareli	parelpareli	‘gather’
/lath/	latha	laala	‘spear’
/neth/	netha	neene	‘strike’
/ŋaalith/	ŋaali	ŋaalŋaali	‘thirst’

The underlying forms of all verb roots end in the verb marker *-th*. This marker protects the final vowel of long verbs from truncation (as in *pareli*) and appears overtly in the simple form of short verbs (like *petha*) preceding the augment *a*.

²⁸ As Itô (1986) shows, the interaction of syllabic well-formedness conditions with constraints on the analyzability of geminates in Lardil and other languages permits the homorganic nasal-stop clusters as well.

It is apparent that verbal reduplication is foot or minimal word sized as well, and it exhibits several properties that we have met with and will again as we treat reduplication phenomena from other languages. In cases like *kelekele*, the consequences of foot reduplication are obvious. Less apparent, but equally straightforward, is the fact that a long vowel, although a single syllable, contains two moras and thus satisfies the foot/minimal word template, as in *ɲaalɲaali*.²⁹ Furthermore, the copying of a final consonant in this case and in *parelpareli* is explained by the independent syllabic well-formedness conditions of the language — only apicals and palatoalveolars are copied finally, because only they are permitted in syllable-final position.³⁰

Examples like *laala* exhibit the strict shape invariance called for by the Satisfaction Condition. Here we find a short vowel copied as long, thereby satisfying the requirement that the reduplicative affix contain two morae. Such requirements are immutable — since there is no erasure of unassociated skeletal positions, all prosodically characterized positions in the affix must be filled in accordance with the requirements of the language. Since no way to fill a mora other than a vowel is permitted in Lardil, what we find is spreading of the vowel to this slot, as in the diagram in (50):

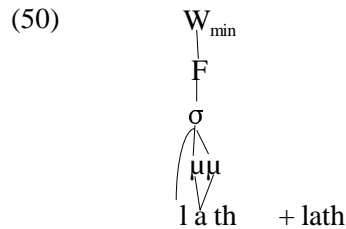

The final *th* is not associated because it is not a licit syllable- (and therefore foot-) final consonant of the language.³¹

The situation in yet another Australian language, Yidiɲ (Dixon 1977; Nash 1979-1980), is somewhat different. The relevant data are as follows:

(51) Reduplication in Yidiɲ

mulari	mulamulari	‘initiated man’
kintalpa	kintalkintalpa	‘lizard sp.’
kalamparaa	kalakalamparra	‘March fly’

In Yidiɲ, the foot is disyllabic, QI (at the point when stress is assigned — cf. section 1), and so stress is assigned to every odd-numbered syllable from the left. It is clear from Dixon’s discussion that the phonology systematically treats Yidiɲ reduplicated words as compounds, just as Diyari does.

We analyze Yidiɲ reduplication as F (= W_{min}), the disyllabic foot, as do Nash (1979-1980) and Hayes (1985). The problem is obviously one of accounting for whether or not the reduplicative affix contains a final consonant. In Diyari, this determination is made solely by word-level prosody — no word-final consonants are licensed, so none appear in the compound reduplicative affix. In Lardil, the same determination is made by

²⁹ This example also exhibits the phenomenon of transfer, which we take up below in section 4.3.

³⁰ In Wilkinson’s analysis, even derived palatoalveolars count for this purpose. Lardil has a rule converting all consonants to the corresponding palatoalveolar before a labial: /pit+puri/ *pit^ɥpuri* ‘smell (source)’, /wik+puri/ *wit^ɥpuri* ‘shade (source)’. This rule applies to the verb marker *th* in reduplications of labial-initial roots, as in the example *patit^ɥpati* already cited, or in *petha/peet^ɥpe* ‘bite’. Given the extensive alternations among apicals and nonapicals in the language, it is likely that this analysis is reconstructible without the notion “derived palatoalveolar”.

³¹ There is an additional complication in Lardil reduplication. We find reduplications like *thaltii/thaltiithaltii* ‘stand up’, where base-final length appears in original and copy. Against this are forms like *patii/patit^ɥpati* ‘sit with legs outstretched’ where length is lost and noun-to-verb reduplications like *ɲarnda/ɲarndaɲarndaa* ‘crotch/spread the legs apart’ in which length appears only in the original and not the copy. It appears that these length alternations have a great deal to do with a poorly- understood rule of final vowel lengthening marking intransitives.

syllable-level prosody — only apicals and palatoalveolars are permitted syllable finally, so only they associate with the right edge of the copy. Yidiṅ exhibits a different situation.

Nash (1979-1980) proposes that only the phonemic melody elements of the first foot in the base are available for reduplicative association. This crucially distinguishes the *r* of *mulari*, which is not in the foot, from the *l* of *kintalpa*, which is. In our terms, this is stated somewhat differently: reduplication is prefixation of the minimal word to the minimal word. Thus, Yidiṅ reduplication comes under the parameter of our theory (and of Broselow and McCarthy's (1983–4)) in which a designated prosodic constituent is the base for reduplicative affixation, rather than a morphological constituent. This situation is obvious and essential in the analysis of certain types of infixing reduplication in section 2.3. In the Yidiṅ case, the prosodic constituent base is initial and it receives a prefix, so positionally the affix appears to be simply prefixed. But the behavior of final consonants reveals the true nature of the process.

Affixation to a prosodic constituent has essentially the same formal properties as affixation to a morphological one. The affix is placed relative to the designated constituent, and only the phonemic melody elements associated with that constituent are copied and available for association. We can now turn to the details of Yidiṅ.

Nash (1979-1980) argues that clusters like *lp* and *mp* are systematically distinguished in Yidiṅ phonology; the latter are prenasalized stops (therefore tautosyllabic), while the former are heterosyllabic. Several factors support this view. First, the only major type of triconsonantal cluster in the language is CNC, where NC is a putative prenasalized stop. Second, various phonological alternations support this interpretation. Third, slow speech pronunciations show the expected loss of prenasalization (which does not occur word-initially), but do not affect true clusters. We will therefore write the prenasalized stops as a single melodic element, *B*.³²

The examples in (51) would then be prosodized as follows:

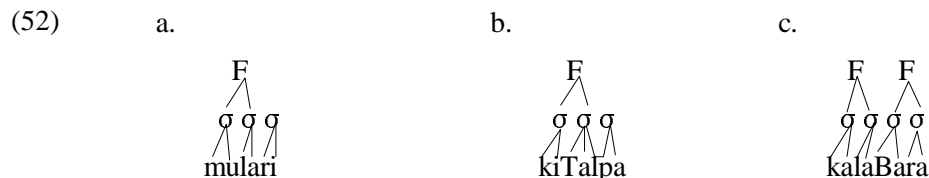

Under our account, affixation to the minimal word (F) means that only the phonemic melody elements associated with this constituent are copied and available for association. This produces exactly the desired result: the only consonant that can associate with the end of the reduplicative skeleton is one that itself is part of the prosodically-characterized base of reduplication — the initial foot of the word. There is no notion of ‘foot-copying’ here; rather, the Yidiṅ paradigm follows from the interaction of the minimal-word base and the minimal-word reduplicative affix.

It is strong evidence in support of this approach that combining independently needed properties of the theory in this way yields results that are otherwise inexplicable. Moreover, we now have a closely parametrized account of the minimal distinction between Lardil *parel-pareli* and Yidiṅ *mula-mulari*: the former characterizes the base of reduplicative affixation in purely morphological terms (the stem), while the latter opts for a phonological characterization (the minimal word). The distinction is not capturable in segmental skeleton terms

³² There is an alternative account of clusters like *mp* that is equally compatible with our theory. If they are regarded as true heterosyllabic clusters, rather than single melodic units, then all facts about their surface distribution will equally well follow from Itô's (1986) licensing theory, presented above in connection with the analysis of Orokaiva. Only homorganic nasal-stop clusters will have the crucial branching structure at the articulator tier, thereby exempting them from various aspects of syllabic well-formedness. The pattern of reduplication in *kala-kalamparaa* (**kalam-kalamparaa*) then follows from the Geminate Constraint constraint as well: the putative minimal word *kalam* would contain only half of a structure that branches at the articulator tier — therefore only *kala* is copied and available for association.

without invoking mechanisms that have the same effect as those we need in any case; it does no good to say that Yidij reduplicates CVCCV because of *kintal-kintalpa*.

Reduplication in Yidij and Lardil

This contrast is analyzed in terms of prosodic circumscription in M&P 1990a.

This account of Yidij suggests an analysis of certain recalcitrant cases in Austronesian languages. We focus on Makassarese. According to Aronoff (1985),³³ reduplication in Makassarese displays a peculiar kind of phonological and morphological sensitivity:

(53) Reduplication in Makassarese

a. Disyllabic Words

ballak	ballak-ballak	‘house’
golla	golla-golla	‘sugar’
tau	tau-tau	‘person’
tauŋ	taun-tauŋ	‘year’

b. Longer Words

kaluarak	kaluk-kaluarak	‘ant’
manara	manak-manara	‘tower’
balao	balak-balao	‘rat’
baine	baik-baine	‘woman’

The consonant *k* is evidently in complementary distribution with *ʔ*; we may therefore regard the *k* appearing at the right edge of the copy in (53b) as an inserted *ʔ*.

The reduplicative affix in Makassarese is obviously disyllabic (the vowel sequences are all heterosyllabic); since the language has penultimate stress and appears to lack monosyllables, this too is an instance of $W_{\min} = F$ reduplication. Aronoff states the generalization underlying these two patterns of reduplication — one without and one with final *ʔ* — as follows. If the boundary of the second syllable copied does not coincide with a morphological boundary, then insert *ʔ* at the end of the second syllable. Otherwise copy the syllable-final consonant if there is one.

Our interpretation of this regularity is the following. In Yidij, the minimal word that is the base of reduplication actually coincides with a foot already present in the form, since stress is assigned from the left. In Makassarese, though, stress is assigned from the right, so the minimal word base must result from a prosodic reparsing of the original from the left. This reparsing simply selects the first two syllables as a minimal word. Copying of the phonemes of this minimal word and association with the affixal minimal word yield the pattern in (53a). The pattern in (53b) (and its near parallel in Tagalog) involves a situation where the minimal word derived by reparsing — the phonologically characterized base — does not exhaust a morpheme. It is precisely in this conflict between morphology and phonology that Makassarese develops the intrusive *k*.

Makassarese Reduplication

The analysis given in the text is incorrect; it cannot account for additional data that were not available at the time. For the evidence, and a different analysis, see Aronoff, Arsyad, Basri, & Broselow 1987. M&P 1990a offers an account of Makassarese based on prosodic circumscription. M & P 1994a develops a complete treatment within Optimality Theory.

³³ Reporting on joint work with Ellen Broselow.

Yidiñ and similar Australian languages, with stress assigned from the left, have no such reparsing, deriving the minimal word base from simple inspection of the foot structure; consequently they can have no such rule. Makassarese and like-minded languages must reparse; they may then compensate for the difference between phonological and morphological edges. The formal characterization of this process in Makassarese remains obscure; but the context is not. Our theory independently requires a minimal word base, derived by reparsing, to achieve the surface pattern of copying in this language. The rule of \int insertion records the success of this reparsing as a measure of morphological integrity. The otherwise inexplicable condition on \int insertion follows from this conception of the phonological base.

Prosodic Reparsing

The notion of prosodic reparsing is developed within circumscription theory in M&P 1995a.

2.2 Suffixation

An adequate theory of suffixing reduplication should derive all differences between prefixes and suffixes from the positional differences between them alone — since an analysis must in any case stipulate the position. As we will see, there are certain important distinctions between prefixing and suffixing types, and we will show how these distinctions are reconstructible in our theory.

THE MINIMAL WORD OR FOOT AS SUFFIX TARGET

Manam (Lichtenberk 1983) displays foot reduplication in the suffixing mode, and it is clear that the foot and minimal word are identical in this language. Underlyingly, Manam syllables are of the form (C)V(N), where N is a nasal homorganic to a following consonant or one of η or m in free variation word-finally. This regularity is supported phonologically by regular *i*-epenthesis after any nonnasal consonants in preconsonantal or word-final position. Vowel-initial syllables are freely distributed, and tautosyllabic vowel clusters or long vowels do not occur.

In general, stress is assigned to the syllable containing the penultimate mora, where a mora is reckoned as either a vowel or a syllable-final consonant:³⁴

- (54) Stress in Manam
- | | |
|---------|--------------|
| siŋába | ‘bush’ |
| soʔáí | ‘tobacco’ |
| lúnta | ‘moss’ |
| malabóŋ | ‘flying fox’ |

The foot is therefore bimoraic in our terms. Two other rules, which have no effect on the morphological function of the Manam foot, retract stress to the antepenult if either the penult is vowel-initial or the antepenult is closed and the penult is not. Both these retraction rules are prohibited from applying in morphologically complex forms.

³⁴ The vowel sequence *oa* is, however, monomoraic. Both final reduplication and initial (monomoraic syllable) reduplication copy *oa* sequences as a single mora: *raboaʔaboaʔa* ‘plumeria’, *goazagoaza* ‘clean (sg.)’, *moamoatubu* ‘heavy (pl.)’, *goagoaza* ‘clean (pl.)’. There are also several phonological indications that *oa* sequences are monomoraic. First, *oa* becomes *wa* when preceded by a vowel, a word-boundary, or a medial labial consonant. Second, *oa* sequences not subject to these rules are reduced to *oë* when stressed if followed by a consonant. These reductions are peculiar to this vowel sequence, and they obviously correlate closely with the behavior of the two types of reduplication.

Manam Stress

The literature on Manam stress has grown in the intervening years. See Chaski 1986, Halle and Kenstowicz 1991, Kager 1993b, and Buckley 1994.

Reduplication in Manam suffixes F, the bimoraic foot:

(55)	Reduplication in Manam		
	salaga	salagalaga	‘long’
	moita	moitaita	‘knife’
	ʔarai	ʔarairai	‘ginger sp.’
	laʔo	laʔolaʔo	‘go’
	malaboŋ	malabomboŋ	‘flying fox’
	ʔulan	ʔulanlaŋ	‘desire’

These forms are entirely straightforward. A bimoraic foot is suffixed, and right-edge-in reduplication applies without regard to syllable structure.³⁵

There are two interesting complications. First, forms ending with two identical syllables reduplicate only a single syllable:

(56)	ragogo	ragogogo	‘be warm’
	ʔoʔo	ʔoʔoʔo	‘be plentiful’

This is clearly a case of haplology applied to the sequence of four identical syllables derived by reduplication. Second, Manam has five monomoraic verb roots, all of which reduplicate only a single mora:

(57)	ra	rara	‘talk to’
	pi	pipi	‘be forceful’

The roots of this type have a number of other peculiarities as well which account for their failure to show the invariant bimoraic reduplicative pattern. All of them irregularly take final stress when unsuffixed: *i-rá* ‘it is bad’, *i-pí* ‘he is forceful’. All but *pi* have disyllabic variants like *raya*. Thus, one option is simply to regard these forms as underlyingly bimoraic, as Lichtenberk (1983) does, taking *raya* as the base. This has an additional advantage — it eliminates the only apparent counterexamples to $F_{\mu\mu} = Wd_{\min}$.

An alternative is to invoke exceptionality. The normal interpretation of this pattern of exceptionality to stress assignment (Hayes 1980, 1983) is a lexical foot — here obviously monomoraic. This lexical foot is sufficient to fulfill the requirements imposed by the foot-sized reduplicative suffix and the Satisfaction Condition.

The treatment of monomoraic bases in reduplication is unambiguous in the parallel case of the Bolivian language Siriono (Priest 1980). With few exceptions, the language has penultimate stress (that is, the foot is trochaic, QI). Reduplication suffixes a copy of the last two syllables (58a), but there is an additional lengthening when monosyllabic bases are copied (58b):³⁶

(58)	Repetitive Reduplication in Siriono		
a.	ñimbuchao	ñimbuchaochao	‘separarse’
	achisia	achisiaasia	‘yo corto’
	embui	embuimbui	‘divide’
	esiquio	esiquioquio	‘quebrar’
	eochi	eochiochi	‘está sin nada’

³⁵ Unfortunately, Lichtenberk reports no examples of reduplication with words of the *lunta* type.

³⁶ These examples are reported in the orthography, not a phonemic transcription.

b.	ño	ñoño	‘no más’
	ja	jaaja	‘todo’

The obvious comparison here is with Lardil. In Lardil, reduplication of monomoraic bases yields a bimoraic copy by spreading of the copy vowel. In Siriono, the mirror image occurs: the original vowel spreads onto the affixal template. In both cases, what we see is enforcement of a universal principle: the prosodic requirements imposed by the affix must be fulfilled. There is no erasure of unassociated melodic elements because there are no unassociated melodic elements.

THE SYLLABLE AS SUFFIX TARGET

Major apparent differences between prefixing and suffixing reduplication arise when we consider syllable-sized reduplicative affixes. The apparent VC suffix of Tzeltal and the apparent CCVC suffix of Kaingang illustrate this difference.

(59) Suffixing σ Reduplication

a. Tzeltal (Berlin 1963, Kaufman 1971)

nit	nititan	‘push’
net’	net’et’an	‘press’
haš	hašašan	‘feel with palm’
čol	čololan	‘make rows’
p’uy	p’uyuyan	‘grind in fingers’

b. Kaingang (Wiesemann 1972; Poser 1982)

Root	Plural stem	
vâ	vâvâ	‘to throw away’
jêmî	jêmîmî	‘to grasp’
kry	krykry	‘to itch’
vâsân	vâsânsân	‘to exert, fatigue’

These are both fairly typical patterns of suffixing reduplication. While Kaingang adds a full syllable, including onset, as Poser (1982) has argued, Tzeltal appears to add only a rhyme, deriving its onset from phonological material already present in the base.

Considered segmentally, while the apparent CCVC suffix of Kaingang is paralleled prefixally, the apparent VC suffix of Tzeltal is not. There are no cases of prefixing reduplication of this type.³⁷ The goal of deriving all differences between prefixing and suffixing reduplication from position alone is obviously not achieved under this conception.

Our approach does derive the difference in a straightforward way. Recall that prefixing reduplication rules (like rules of prefixation in general) differ in whether or not the juncture between affix and base is transparent to the Onset Rule. Where the juncture is transparent, we get the pattern of Mokilese, Orokaiva, or Ponapean, but where it is not we find systems like Sundanese or Ilokano. The same difference is at work in suffixation. The transparent juncture produces the Tzeltal pattern; the opaque one derives Kaingang. Thus, the VC suffix that is apparently restricted to suffixes has a straightforward place in our account.

Alignment in Suffixing Reduplication

See the discussion and references in the first box on p. 13.

³⁷ Tübatulabal, which has been considered to be of this sort (Levin 1983), is discussed in section 3.2.

Exercising the typological resources of our theory on suffixing reduplication yields some other conclusions as well. We have found no cases of bimoraic syllable suffixation. This gap does not appear to be a principled one; the relative rarity of suffixing reduplication, joined with the relative rarity of bimoraic reduplicative affixes, is sufficient to account for it. The absence of stipulated monomoraic or core syllable suffixes is more deep. What data would force such an analysis? A word like hypothetical *badag* would copy only *da*, yielding *badagda*. But this violates a quite general condition on the locality of reduplication — the identical strings must be strictly contiguous. This condition is expressed in Marantz (1982) via phoneme-driven association, and in our approach it follows from the rigid restrictions we impose on skipping melody elements (v. section 4).

A final case of suffixing reduplication uses the mechanisms of our theory to solve an outstanding problem in skeletal theory. The contribution of Everett and Seki (1985) on Kamaiurá represents the sole argument for the overt phonological status of unassociated skeletal elements. Recall that one of the tenets and purposes of the prosodic theory of skeleta is to eliminate the phonologically impotent unassociated skeletal elements by requiring that the entire skeleton, conceived prosodically, be filled. A major problem with segmental conceptions of the skeleton, represented by C/V or X units, is that unassociated units must be erased immediately, else they would do harm to the phonological and morphological derivation.

Everett and Seki's claim is that, in Kamaiurá reduplication, unassociated skeletal units not only do no harm, but in fact do positive good. Their view is that Kamaiurá has a CVCVC reduplicative suffix, and a surface constraint prohibiting consonant clusters except in word-final position. This constraint is expressed by a cluster simplification rule of the skeletal tier, $C \rightarrow 0 / __C$, which is evidently independently motivated.

(60) Reduplication in Kamaiurá (Everett and Seki 1985)

ohuka	ohukahuka	'he laughed'
ojenupâ	ojenupânujâ	'he hit himself'
ereo	ereoreo	'you go'
omotumuŋ	omotutumumuŋ	'he shook it'
omokon	omokomokon	'he swallowed it'
apot	apoapot	'I jump'

The relevant cases in Everett and Seki's analysis are those like *apoapot*, where the root consonant is apparently lost before the reduplicative suffix. The derivation proceeds as follows:

(61)

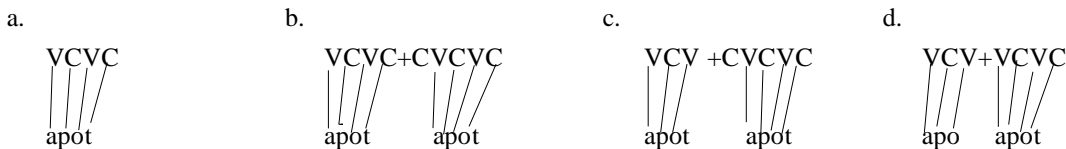

Affixation and association proceed normally, as in (61b), but the unassociated initial C of the suffix is not erased. Now, even though the *t* does not precede a consonant, its associated C does precede another C, albeit an empty one. This is sufficient to trigger the CC simplification rule, yielding (61c). Erasure of unassociated skeletal and melodic elements yields (61d). The thrust of this argument is that application of the cluster simplification rule intervenes between reduplicative association and the erasure of unassociated skeletal elements.

There are two difficulties with this account. First, since unassociated skeletal C or X slots are otherwise invisible to the phonology in all other languages, it is surprising that just in this one case they should exert such influence. The second problem is related to the first, but is far more important. As Itô (1986) demonstrates, phonological theory must countenance a general process of erasure of unsyllabified elements, Stray Erasure. Stray Erasure, which is needed in any case, is sufficient to account for the Kamaiurá cluster-simplification phenomenon. Syllable-final consonants are licensed only word-finally, and so the rule of cluster simplification is apparently

redundant with respect to a universal phonological condition — Stray Erasure — and the independently-needed syllabic well-formedness conditions of this language.

Our alternative account is as follows. Kamaiurá syllable structure is simply (C)V, with the option (C)VC possible only in word-final position (conceivably by moraic extrametricality). The phenomenon of cluster simplification is a consequence of this reduced syllabic structure and Stray Erasure. The reduplicative suffix is $\sigma\sigma$, and we must stipulate that the base-suffix juncture is opaque to the Onset Rule in any case, simply to derive *omokomokon* rather than **omokonokon* (which would correspond to the transparent Tzeltal pattern). These requirements are sufficient to derive *omokomokon* and *apoapot* as follows:

(62)

	a.	b.
Underlying	$\begin{array}{c} \sigma \quad \sigma \quad \sigma \\ \quad \quad \\ \text{omokon} \end{array}$	$\begin{array}{c} \sigma \quad \sigma \\ \quad \\ \text{apot} \end{array}$
Reduplication	$\begin{array}{c} \sigma \quad \sigma \quad \sigma + \sigma \quad \sigma \\ \quad \quad \quad \quad \\ \text{omokon omokon} \end{array}$	$\begin{array}{c} \sigma \quad \sigma + \sigma \quad \sigma \\ \quad \quad \quad \\ \text{apot apot} \end{array}$
Stray Erasure	$\begin{array}{c} \sigma \quad \sigma \quad \sigma + \sigma \quad \sigma \\ \quad \quad \quad \\ \text{omoko mokon} \end{array}$	$\begin{array}{c} \sigma \quad \sigma + \sigma \quad \sigma \\ \quad \quad \quad \\ \text{apo apot} \end{array}$

In the second step of the derivation, the syllable-final consonants of the bases, now no longer word-final, are in unlicensed positions and so must desyllabify. The Onset Rule is simply unavailable, and so the unsyllabified consonants are erased. Kamaiurá has no rule of consonant-cluster simplification — rather, it has quite rigid constraints on syllabic well-formedness and the universal principle of Stray Erasure.³⁸

Kamaiurá Reduplication

M&P 1993a argue that Kamaiurá shows pre-final-coda-C **infixing** reduplication, a symmetric counterpart to post-initial-onsetless-syllable infixation, as in Uradhi and Timugon Murut (immediately below), Sanskrit and Orokaiva (misanalyzed above p.11,15). Chamorro is another similar case, identical to Kamaiurá except for the size of the reduplicant — see below, p. 44.

2.3 Infixation

Partial reduplication comes not only in the prefixing and suffixing varieties, but also infixing. In our account of infixing reduplication, we adopt some of the typological distinctions made by Broselow and McCarthy (1983–4), but in our formal system a somewhat different interpretation is given to these phenomena.

Broselow and McCarthy identify two major types of infixing reduplication. One, exemplified by the Samoan pattern of section 2.3.2, involves precisely the same mechanisms exhibited by prefixing and suffixing

³⁸ There is an alternative account of Kamaiurá within our theory as an instance of infixing reduplication. Rendering the final consonant extraprosodic and suffixing $\sigma\sigma$ will produce the same results. This analysis is vulnerable to one of the criticisms that Everett and Seki raise against a quite different sort of infixing analysis — it fails to derive the apparent loss of a consonant from independently motivated rules of the language. The analysis presented in the text is obviously not susceptible to this criticism.

reduplication, but where the base of the affixing operation is not a morphological constituent but rather a phonological one. The other type, which is known through the Arabic, Temiar, and Zuni patterns, inserts a copy of a peripheral segment at some relatively remote position inside the root. We differ from Broselow and McCarthy in that we see this sort of behavior as unique to root-and-pattern or templatic morphological systems and involving the exercise of the rather special morphological properties of such systems.

Our greatest point of difference with earlier work is the recognition of a third type of infixing reduplication, one which can be detected by a conjunction of two phenomena: copying of some string at a morphological periphery, but where the copied string does not contain some peripheral segment(s) and appears ‘inside’ that segment(s). This, the most common pattern of infixing reduplication, is attributed to peripheral extraprosodicity on the melodic tier and involves considerable interesting exercise of the resyllabification mechanisms we have developed.

It is argued, then, that infixing reduplication is not a single phenomenon with a unitary formal explanation, but rather is the result of the intersection of various formal parameters of the theory.³⁹

INFIXATION VIA EXTRAPROSODICITY

Infixing reduplication of this type can be diagnosed by the following characteristic: the placement of the copied string is relative to some element(s) that is not itself copied. This element is invariably peripheral (or a peripheral string). Our theoretical interpretation is that this element exhibits melodic extrametricality only. The effect of this extrametricality is solely that the designated melodic element is detached from the skeleton of the base; it is still available for copying and association with the reduplicative affix. Melodic extraprosodicity is therefore to be distinguished from templatic extraprosodicity. The latter is associated with a particular constellation of properties in prosody (Hayes 1982b, Prince 1984) and melody copying (Steriade 1982). We invoke melodic extraprosodicity as well to account for peripheral incompletely-formed prosodic constituents — see the discussion of Arabic in 2.4.

Prefix as Infix

In the following examples, the extrametrical elements and the skeletal affix are indicated after the name of the language:

(63) Infixing Reduplication

Pangasinan I (Benton 1971:99): #V EM, prefix σ_c

Singular	Plural	
amigo	amimigo	‘friend’
kanayon	kakanayon	‘relative’
libro	lilibro	‘book’
niog	niniog	‘coconut’
plato	paplato	‘plate’
balbas	babalbas	‘beard’

³⁹ Broselow and McCarthy (1983–4) discuss three putative examples of infixing reduplication which we disregard here on the grounds that they are almost certainly misanalyzed. Quileute, a Chimakuan language of the Northwest Coast (Andrade 1933), is reported to have a frequentative reduplication that takes *qa:le?* to *qaqle?* ‘he failed’ and a plural that takes *qa:war?* to *qa:qe:war?* ‘potato’. It is simply impossible to rule out a phonological account of these phenomena — in particular, deletion of a reduced vowel in /qaqale?/ would make a great deal of sense in the overall context of the phonology of these languages. The Takelma example, in which the root *hemg* ‘take out’ has aorist *hemeg* and frequentative *hememg*, has been convincingly demonstrated by Goodman (1983) to be a case of root-and-pattern morphology complete with vowel and consonant segregation (see also Lee (forthcoming [1991])). The apparent reduplication, then, is nothing more than spreading of vocalic and consonantal elements to empty skeletal slots. Finally, Nakanai, a language claimed to exhibit several infixing reduplication processes under complex phonological control, on closer inspection turns out to have foot-suffixing reduplication with a number of reduction processes applied to the now-distressed original.

Pangasinan II (Benton 1971: 151): #V EM, prefix σ		
Numeral	'only'	
sakey	saksakey	'one'
talo	taltalora	'three'
apat	apatpatira	'four'
anem	anemnemira	'five'
siam	siasiamira	'eight'
Uradhi (Crowley 1983): #(C)V EM, prefix σ .		
Verb	Continuous	
wili	wilili	'run'
ipihi	ipipihi	'swim'
wampa	wampampa	'float'
un ^y t ^y a	un ^y t ^y an ^y t ^y a	'sleep'
uhya	uhihya	'eat'
ikya	ikikya	'speak'
Mangarayi (Merlan 1982): #C EM, prefix σ .		
Singular	Plural	
gabuji	gababuji	'old person'
yirag	yirirag	'father'
jimgan	jimgingan	'knowledgeable one'
wangij	wangangij	'child'
muygji	muygjuygji	'having a dog'
Timugon Murut (Prentice 1971): V-initial σ EM /#___, prefix σ .		
	Diminutive/Instrumental	
bulud	bubulud	'hill'
tulu?	tutulu?	'point at'
dondo?	dodondo?	'one'
ulampoy	ulalampoy	not glossed
indimo	indidimo	'five times'
ompod	ompopod	'flatter'

Consider first of all the Mangarayi example. Induction over the cited examples provides an assessment of Mangarayi syllable structure that fairly well accords with the facts; syllables are CV(C), with CVCC syllables occasionally occurring. Since this language has no vowel-initial syllables, it is actually sufficient to say that any initial melodic element is rendered extraprosodic and a syllable is prefixed. The derivation, then, proceeds as follows:

(64)

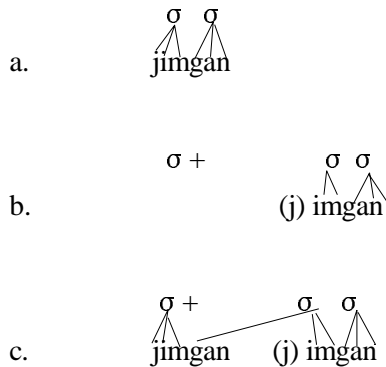

In (64b), we see the immediate result of the reduplication rule. An empty σ is prefixed, and the initial melody of the base is marked as extrametrical (indicated here by parenthesization). The effect of this is exclusively to detach *j* from the base skeleton. With phonemic melody copying in (64c), we see the result of association. Left-to-right association of the copied melody with the empty σ yields the syllable *jim*, as expected, but a further thing happens. As in all cases of infixing reduplication, the Onset Rule applies, linking the next phonemic element *g* with the empty onset of the initial σ of the root.

Consider what the generalization underlying the Mangarayi facts is. The rule could be paraphrased as ‘after the initial consonant, insert a copy of the first VC* sequence, where C* is the maximal licit intersyllabic consonant cluster of the language.’ Obviously C* represents a finite number of consonants, so there is a paraphrase in terms of a CV skeleton or X skeleton which will work, but the underlying generalization that this precisely replicates the intersyllabic clustering possibilities — whatever they are — is not captured. The approach we offer, in which the ‘copied’ melody shares skeletal associations with prefix and base, captures exactly that generalization by exploiting the syllabic well-formedness conditions of the language and a minimal stipulation of extraprosodicity, just sufficient to indicate that this underlying prefix appears on the surface to be an infix. Moreover, we relate the C* pattern of infixing reduplication to the universal Onset Rule, to the prefixing reduplication of Mokilese or Orokaiva, and to typological differences in suffixing reduplication.

This approach also provides for a straightforward learning theory even for systems as complex as Mangarayi. Learning the Mangarayi rule requires only the following steps: (1) recognize that reduplication is involved; (2) subtract the canonical pattern of the original (say, $\sigma\sigma$) from the canonical pattern of the derived form (say, $\sigma\sigma\sigma$) to determine the form of the affix; (3) establish the location and extent of extraprosodicity. The crucial step is the second; only under a prosodic conception of the skeleton is the determination of the shape-invariant in Mangarayi reduplication so trivial.

Infixing Reduplication

The basic line of attack here, which sees this form of infixing reduplication as a variant of straightforward prefixation/suffixation, is surely on the right track. The use of extraprosodicity to deal with peripheral material is also a reasonable first cut at the problem of getting the infix inside the base; on this, see also Kiparsky 1986. But the view of extraprosodicity as desyllabification is clearly incorrect — it cannot explain why the “extraprosodic” segment of the base is available for copying, yet not for association. A superior account of extraprosodicity emerges from the theory of prosodic circumscription in M&P 1990a, in which the extraprosodic or ‘negatively circumscribed’ material is available for neither copying nor association. All extraprosodicity-based accounts, however, fail to relate the shape of the affix to the conditions of its insertion. This relationship is obtained when infixation is occasioned by domination of Alignment constraints, as in M&P 1993a: Chapt. 7 and Prince & Smolensky 1991, 1993.

If infixing reduplication is to be accounted for by peripheral extraprosodicity together with the mechanisms of affixation and association, it is to be expected that other infixes — those that appear to be fully specified, will exhibit similar properties. This is in fact the case. Consider, for example, the characteristics of the plural *ar* infix of Sundanese (Robins 1959), evidently the only productive infix in this language

(65) Infixation in Sundanese

Singular	Plural	
niʔis	nariʔis	‘to cool oneself’
naho	naraho	‘to know’

This infix lodges immediately after the first consonant of the base. Under our proposal, this infix will appear as in (66a), and the derived representation of *nariʔis* will appear as in (66b):

(66)

a.



b.

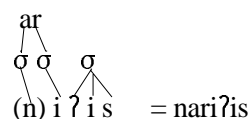

Here, the Onset Rule has applied twice. One application links the floating *n* with the affixal σ , and the other resyllabifies *r* of the infix with the initial σ of the base. The representation of the affixal melody on a separate tier is independently required by Sundanese nasal harmony (Hart 1981) and by observations about infixes in numerous languages (McCarthy 1981).

Virtually identical forms of infixation are met with in other Austronesian languages as well. A particularly interesting case, in which moraic specifications are also exercised, are met with in the Philippine language Balangao (Shetler 1976). Balangao has quite a few infixes, including a contrast between distinct morphemes *in* and *inn*, both appearing after the initial consonant:

(67) Infixation in Balangao

a. *in* Infixation

Singular	Plural	
bubae	binubae	‘girl’
madʔan	minadʔan	‘old woman’

b. *inn* Infixation

Root	Derived Form	
bayu	binnayu	‘pound’
balon	binnalon	‘lunch’
basol	binnasol	‘sin’

The skeletal representation of the *in* infix is identical to that of Sundanese *ar*, but the *inn* infix is represented lexically with a bimoraic syllable, as in (68a). The Onset Rule, then, does not effect complete reassociation (because the bimoraic syllable blocks that), but rather simply adds an association line, to yield the result in (68b):

(68)



The contrast between geminating and nongeminating applications of the Onset Rule in the two Balangao infixes is also seen in our discussion of prefixing reduplication systems like Mokilese/Ponapean and Orokaiva: when the affix is a heavy syllable, we get gemination; when the affix is a syllable of unspecified weight, we get simple resyllabification. Although the bimoraic pattern is not attested among our cases of infixing reduplication, it does arise here in a case of fully specified infixation.

There is another interesting point about infixation that our proposals explain. Examples like Sundanese and Balangao, as well as the broader evidence from language games described in section 3.1, demonstrate that the locus classicus of infixation — after the first consonant — is reserved for infixes of an apparent VC canonical pattern. This follows elementarily from the need to integrate the infix into the syllabic structure of the base; an apparent CV infix could not in general do this. Thus, the usual character of nonreduplicative infixes (vowel-initial syllables) follows from the requirements of the syllable — there must be an empty onset to which the initial extrasyllabic consonant of the base associates.

VC Infixation

The observation that infixation of VC prefixes is related to syllable structure was originally made by Anderson 1972 (also see Cohn 1992). But as Prince & Smolensky 1991b, 1993 observe, none of the proposed analyses are able to make a formal connection between infix placement and syllabic well-formedness/unmarkedness. Their account, by contrast, calls directly on the syllable-structure constraint, NO-CODA, which dominates and forces minimal violation of the constraint demanding peripheral placement of the affix. On *moraic* infixation (gemination), see Samek-Lodovici 1992, 1993.

The identification of infixation with extrasyllabicity naturally leads to the question of what sorts of elements can be extrasyllabic. Obviously a single initial consonant (Mangarayi) or vowel (Pangasinan) can be disassociated in this way, but can sequences be extrasyllabic? Inspection of the other cases in (63) is somewhat misleading, since in both of them certain peculiarities of the syllable structure make the situation less than clear.

The Paman language Uradhi is in the unusual situation of having relatively few words that do not begin with a vowel. The statement in (63), which renders a (C)V sequence extrasyllabic, is intensionally equivalent to the description in Crowley (1983), but in fact, all the cited examples begin with a vocoid of some sort, and the materials available to us provide no instances of reduplication applied to a word with an initial true consonant.

Certainly all examples are consistent with an account in which #[-cons] is rendered extrametrical, in which circumstance we have derived representations like those in (69):

(69)

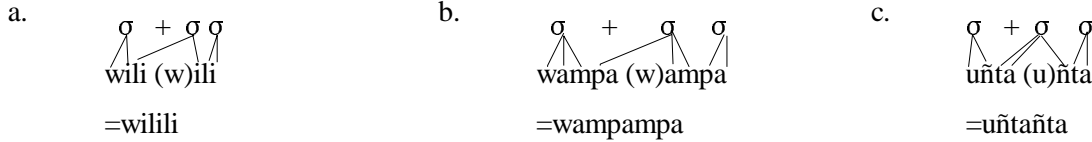

In the final example, not only the Onset Rule but also the Nucleus Rule have applied from the copied phonemic melody to the base skeleton, again as required by the well-formedness conditions of the language (that is, syllables must have [-cons] nuclei).

We have, then, insufficient information to determine whether Uradhi is applying extraprosodicity to a sequence. Timugon Murut, on the other hand, seems far more clearly to detach an entire vowel-initial syllable. This in itself is unsurprising — in stress systems, syllabic extrametricality is the norm, and even nonconstituent sequences are sometimes extrametrical (witness the treatment of *ga(laxy)* in Hayes 1982a).

Uradhi and Timugon Murut Reduplication

These two languages, and others cited in (63) (except Mangarayi), place a reduplicative infix after an initial onsetless syllable. Remarkably, only *reduplicative* infixes have this distribution — an observation that cannot be made to follow from extrametricality or its generalized and sharpened successor, prosodic circumscription (as developed in M&P 1990a, 1991b). An explanation emerges under the assumption that such infixation results from domination of an Alignment constraint by syllable structure constraints. The core idea is that infixation of a reduplicative prefix past initial V avoids duplicating a violation of the constraint ONSET, whereas infixation of fixed-segmentism affixes has no such effect. See M&P 1993ab and cf. Downing 1994, 1995ab, 1996.

Murut also has some special restrictions on syllabic well-formedness, although these are not unusual. In Timugon Murut, the only licit intersyllabic clusters are sequences of homorganic nasal and stop. The conditions on syllabic structure, and their interaction with the Geminate Constraint in Itô's (1986) proposal, are identical to those of Orokaiva in section 2.1. As in Orokaiva, it follows that that no syllable-final consonant can be copied. Witness the derived representations:

(70)

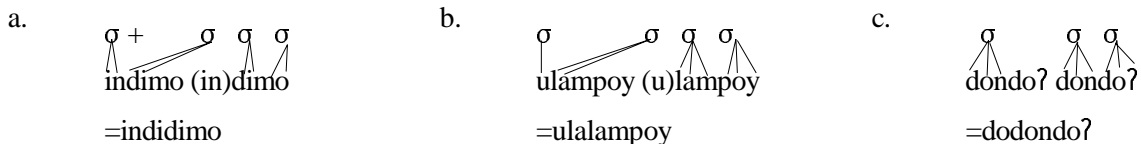

Even when a homorganic consonant follows, as in (70c), the nasal cannot be associated because the structural requirements of Itô's explanation are not met. The first *nd* sequence in **dondondo?* does not have the required shared feature structure, since it is composed partly of copied melody and partly of original. We could, of course, stipulate this result, but it is obviously far more attractive to derive it from independently needed properties of this language and of phonological theory.

What has to this point remained the most recalcitrant system of infixing reduplication — that of the Hokan language Washo — also submits to analysis under our assumptions. The fundamental logic of Washo

reduplication is that the reduplicated form is longer than the unreduplicated one by exactly one monomoraic or core syllable:

(71)	Washo (Jacobsen 1964, Winter 1970, Broselow & McCarthy 1983–4)		
	Singular	Plural	
	daʔa	daʔaʔa	‘mother’s brother’
	damal	damamal	‘to hear’
	maagu	magoogo	‘sister’s child’
	c’iige	c’igeege	‘to scratch’
	duweʔ	duweweʔ	‘to try to’
	baliʔ	balaliʔ	‘to shoot’
	šemug	šemumug	‘brother’s child (of woman)’
	ic’iš	c’ic’iš	‘black’
	ac’im	c’ac’im	‘green, yellow’
	emc’i	c’imc’i	‘to wake up’
	ipc’ib	c’ipc’ib	‘perfect’
	saksag	sasaksag	‘father’s father’s brother’
	nent’uš	net’unt’uš	‘to be an old woman’
	mokgo	mogokgo	‘shoe’

The puzzle presented by Washo is the precise nature of the reduplicative affix. Essentially following the analysis of Winter (1970), Broselow and McCarthy (1983–4) identify the reduplicative affix as VCV, inserted after the initial consonant. Association of melody with affix is contrived so that the first V is associated with the first vocalic melody of the stem, the second V with the second vowel, and the C with the intervocalic consonant or the second consonant of any medial cluster. A resulting form like *c’-ige-iige* then undergoes coalescence of the medial vowel sequence, yielding a derived representation with the length of the second vowel and and quality of the first or second, depending on their exact featural makeup. (Compare *c’igeege* in which the first vowel of the derived sequence wins with *balaliʔ* in which the second prevails.) Finally, initial unstressed vowels are deleted, yielding forms like *c’ac’im* from intermediate *ac’i-ac’im*.

The reduplicative affix VCV is obviously not straightforwardly discoverable from the alternations — as we noted, the difference between singular and plural is simply that the latter is longer by one monomoraic syllable (modulo initial vowel deletion) than the former. Instead, we assert that the immediate result of reduplication is as follows:

(72)

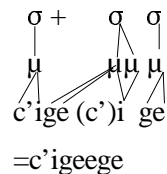

In other words, the affixal skeleton is responsible only for the copying of the first CV sequence of the base. The medial consonant is copied via the Onset Rule, and the second vowel of the copy is linked to the base syllable as well. It is this latter move that is responsible for the array of Washo vowel coalescence phenomena.

There are two arguments for this approach to vowel coalescence. First, it accounts for the otherwise unexplained preservation of the length of the vowel under coalescence. This is an otherwise abnormal result of coalescence cross-linguistically, which typically yields vowels that are long or short uniformly in any given language. Second, it accounts as no other analysis can for the identical facts of coalescence elsewhere in the

language. Washo has two types of morpheme-final vowels. The majority show up unchanged in all contexts, only inducing an intrusive *y* before following vowels (Jacobsen 1964:260):

(73)	/aadu/	‘hand’
	aadu	‘hand’
	aaduya	‘in hand’ (cf. <i>aŋala</i> ‘in house’)
	aadolu	‘with hand’

But some apparent morpheme-final vowels have a quite different distribution, impossible in VC__CV or __#, coalescing with a following vowel, and emerging overtly only when in the middle of an unsyllabifiable cluster (Jacobsen 1964:286, 296):

(74)	/ge/	‘Imperative’	
	gasaw	‘laugh!’	< asaw
	gelšim	‘sleep!’	< elšim
	gešim	‘sing!’	< išm)
	geege	‘grind!’	< iige ⁴⁰
	gebeyu	‘pay him!’	< beyu

The coalescence effects seen with the morpheme-final vowels of this type are identical to those in internal reduplication — length of the second vowel is preserved, and likewise the quality of one or the other prevails depending on the relationship between them (cf. *huubiʔi* from /hu+iibiʔ+i/, where /hu/ also contains this type of morpheme-final vowel). The emergence of a full independent vowel seen in the final example is obviously conditioned by syllable structure; it respects Washo’s avoidance of tautosyllabic clusters.

Our interpretation of this phenomenon is that a morpheme like /ge/ is represented lexically with no prosodic structure.⁴¹ It therefore parasitizes its environment by linking both its consonant and vowel to any following syllable if possible — that is, just in case the following syllable is vowel-initial. This circumstance, in which two different vowels are linked to a single syllable, will uniquely trigger the Washo coalescence rule. In word-final or preconsonantal position, no such move is possible. Cases like *gebeyu*, where the prosodically empty morpheme shows up as an independent syllable, will be the result of an epenthesis (that is, syllable-creation) rule that the language needs in any case.

The advantages of this approach are several. First, it provides a natural account within the overall theory of the distinction between coalescing and noncoalescing morpheme-final vowels, since only the former are not provided lexically with prosodic structure. Second, it explains why the first vowel in coalescence is irrelevant to determining the length of the resulting vowel, since coalescing vowels have no mora to contribute. Third, it accounts for the otherwise inexplicable absence of a length distinction in coalescing vowels, despite the fact that all true vowels of the language have both long and short counterparts. Fourth, it accounts for the defective surface distribution of coalescing vowels — they can only occur independently where epenthesis would apply anyway, and they can only occur covertly where a vowel-initial syllable permits them to coalesce. Fifth, it accounts for the defective underlying distribution of coalescing vowels as well — they are restricted to morpheme-final position, even in longer morphemes, presumably because, in conjunction with the usual constraints on extraprosodicity, unsyllabified elements must be peripheral.

All properties of the medial vowels in reduplicated forms then fall out from this independently-motivated conception of the coalescence phenomenon. Only a single issue in Washo remains. Since we have identified this system of reduplication as prefixation of a monomoraic or core syllable, the direction of association must be left

⁴⁰ Constructed on the basis of the discussion in Jacobsen (1964: 294).

⁴¹ A morpheme like *c’ilu* ‘descriptive of hips’, which ends in a vowel that undergoes coalescence, will have lexical prosodic structure only for its first vowel.

to right. This accounts correctly for the initial CV sequence, which exhausts the monomoraic affix, and the independently needed coalescence rule accounts for the linking of the second vowel melody to the former initial syllable. But there is no obvious account for the behavior of the Onset Rule, which normally associates the second consonant of a medial cluster (as in *ʔešiwšič*, **ʔewiwšič*). We could consider this to be the normal behavior of such applications of the Onset Rule, distinguishing it from the left-to-right association of melody with affix. As it happens, none of our other cases of Onset Rule application provide the critical conjunction of circumstances that Washo has, so this solution is necessarily somewhat speculative.

Washo Reduplication

De Haas 1988 presents a strong argument against an analysis of Washo based on vowel coalescence: in all other known cases, coalescence yields a long vowel (or a short one, in languages where long vowels are prohibited); it never preserves a length contrast the way Washo does. (Sanskrit, for example, is typical in this respect.) Urbanczyk 1992 develops an account of Washo based on negative circumscription of a mora that does not require coalescence, and so escapes this criticism. For discussion of coalescence within Optimality Theory, see Lamontagne & Rice 1995, McCarthy 1996.

Suffix as Infix

In view of the general scarcity of suffixing reduplications, it is not surprising that suffixing reduplication in the infixing mode is also poorly attested. We know of two examples, both exhibiting exactly the same pattern:

(75) Suffixing Infixing Reduplication

Chumash (Applegate 1976: 275)

Lexical		
walalaq'		'lichen'
oxoxon		'cough'
halala		'to quarrel'
hamama		'so much!'
oxyoyon		'to be crazy'
muc'uc'uʔ		'small bead' (cf. muc'uʔ 'small')
mixixin		'to be hungry' (cf. mixin 'id.')

Korean (Kim 1984)

culuk	cululuk	'dribbling'
asak	asasak	'with a crunch'
t'alij	t'alilij	'ting-ting'
holok	hololok	'sipping'
allok	allok	'mottled'

With the final consonant melody rendered extrasyllabic in our sense, suffixation of a σ yields the desired pattern.

Korean Reduplication

For further discussion of Korean reduplication, see Jun 1994 and Lee & Davis 1993.

INFIXATION VIA AFFIXATION TO A PROSODIC CONSTITUENT

The vocabulary of prosodic constituents — word, foot, and syllable — provides not only a theory of possible reduplicative affixes but also a theory of possible bases of reduplication. It is, of course, most normal for reduplicative or other affixes to adjoin to words, characterized either phonologically or morphologically at some stage of the derivation. There are, however, some cases where one of the lower-order prosodic constituents functions as the base for reduplicative affixation (Broselow and McCarthy 1983–4). We can detect such phenomena most directly only when the conjunction of affix position (prefix vs. suffix) and location of the base constituent is such that the reduplication appears to take place root internally. Such is in fact the case in the following examples:

(76) Infixation via Affixation to Prosodic Constituent

a. Prefixation of core/monomoraic syllable to (main-stress) foot

Chamorro Continuative (B&M 56)

saga	sasaga	‘stay’
egga	eʔegga	‘watch’
hugando	hugagando	‘play’

Samoan Plural (B&M 30)

taa	tataa	‘strike’
nofo	nonofo	‘sit’
alofa	alolofa	‘love’

b. Prefixation of bimoraic syllable to final syllable

Afar Intensive (Bliese 1981:127)

usuul	usussuul	‘laugh’
biyaak	biyayyaak	‘hurt’
idigil	idigiggil	‘break’
ʃamm	ʃamʃamm	‘throw’
ess	essess	‘take out’

c. Prefixation of core/monomoraic syllable to final syllable

Chamorro Intensifying (B&M 56)⁴²

dankolo	dankololo	‘big’
bunita	bunitata	‘pretty’
metgot	metgogot	‘strong’
ñalalɔŋ	ñalalalɔŋ	‘hungry’

The typological possibilities afforded by the proposals we have made are obviously not exhausted by this list, but the coverage is nevertheless respectable for a domain involving an indisputably rare phenomenon. We exhibit cases in which both foot and syllable are the base (examples of word as base are provided elsewhere), and we show various modifications of the simple syllable appearing as the affix. The only conspicuous lacuna is the absence of languages with suffixation to a prosodic constituent. This is not astonishing; affixation to a foot — the prevalent pattern — must arise historically through a reanalysis in which affixation to short words (those one foot long) is extended to less common long words. Thus, the relative scarcity of suffixing reduplication in general produces this apparent skewing.

The fundamental premises of affixation to a prosodic constituent are no different from those of prefixing and suffixing reduplication. The specified base of the reduplication — characterized prosodically rather than

⁴² There is an alternative analysis of Chamorro in our terms — final C EM and suffix σ .

grammatically — contributes the phonemic melody material available for association and also is the unit with respect to which the linear order relations of the affix are defined.

Infixation by Affixation to Prosodic Constituent

This is analyzed as positive prosodic circumscription in M&P 1990a, and additional cases are presented. An account in terms of subcategorizational Alignment constraints, much closer to the analysis here and in Broselow & McCarthy 1983-4, is given in M&P 1993ab. On Samoan, see Levelt 1990. On the role of circumscription within OT, from Maori, see de Lacy 1996.

2.4 Templatic Morphology

The first arguments for morphological skeleta came from consideration of a purely templatic system, the derivational categories of the Arabic verb. Such systems are characterized by nearly complete independence of melody from skeleton throughout the morphology. In addition to this pure templatic morphology, there are at least two other types of templates which typically occur in languages without pervasive reliance on this mode of word formation. Templatic truncation phenomena involve massive reductions in word size under specific morphological requirements. In another class of cases, morphemes of a particular type are required to meet a templatic shape, even though no direct support from alternations supports active enforcement of this requirement.

TRUNCATION

What we are calling here truncation is not that; it is specification of a template to which the melody (possibly enhanced with some prosodic structure along the lines developed in 4) is directly associated. Words are not being chopped to fit by leaving off prosodic units. Instead, starting at some designated point, the melodic elements of a word are associated with a template, providing a nearly universal analogue to the morphological resources of Semitic.

Most commonly in systems of vocative or nickname formation, but occasionally elsewhere, languages enforce a foot/minimal word template, resulting in systematic patterns of shortening input words:

(77) Truncation

Yapese (Jensen 1977: 101, 114)	W_{\min}
Full Noun	Vocative
luʔag	luʔ
bayaad	bay
maŋeefeel	maŋ

Central Alaskan Yup'ik Eskimo (Woodbury 1985) F (= W_{\min} ?)

<i>Full Noun</i>	<i>Proximal Vocative</i>
Aŋukaŋnaq	Aŋ ~ Aŋuk
Nupiŋak	Nup ~ Nupix/Nupik
Cupəl:aq	Cup ~ Cupəl
Aŋivŋan	Aŋif
Kalixtuq	Kal ~ Kalik
qətunŋaq	Qət ~ Qətun
Maŋ ^w luq	MaX ^w
Aŋnaŋayaq	Aŋən
NəŋqəXalŋia	Nəŋəq
Qakfaŋalŋia	Qak ~ Qakəf
Akiuŋalŋia	Akiuk

Afar (Bliese 1981: 97, 267) $\sigma+am$ (= W_{\min} ?)

<i>Frequentative</i>	<i>Gloss</i>
tokam tokmeeni	'you (pl.) ate'
yuŋam yuŋrufeh	'he rested'
aram argaŋuk	'he cut'
tifam tifiŋ	'it dripped'
tubam tubleeni	'you (pl.) saw'
yamam yamaateeni	'they come'

Japanese (Poser 1984a, 1984b:42ff, Itô p.c.) F(F)

a. Hypocoristics

<i>Name</i>	<i>Hypocoristic</i>
midori	mii+tyaN mit+tyaN mido+tyaN
siNzaburoo	siN+tyaN siNzabu+tyaN
wasaburoo	waa+tyaN wasa+tyaN sabu+tyaN wasaburo+tyaN

b. ICU Student Argot

iN kuri	'Introduction to Christianity'
zyene edo	'General Education'
iN liN	'Introduction to Linguistics'
fure maN	'freshman'
iN toro	'introduction'

c. Abbreviations

paasonaru koNpyuutaa	paso koN
waado purossaa	waa puro
imeezyi tyenzyi	ime tyen
paNtii sutokkiNgu	paN suto
konekusyon	kone
sutoraiki	suto
zeminaaru	zemi
irasutoreesyon	irasuto

We have presented a rich variety of examples because this type of templatic morphology has been insufficiently recognized in the literature. Let us take each case in turn.

More on Truncation

The literature on truncation is much more extensive now than it was in 1986. It includes a comprehensive survey by Weeda 1992, new theoretical developments in Benua 1996, and treatments of particular languages, including (and this is only a sample) Arabic (McCarthy and Prince 1990b), Swedish (Morris 1989), French (Plénat 1984, Steriade 1988, Scullen 1993), Spanish (de Reuse n.d., Crowhurst 1992a), Nootka (Stonham 1990), Choctaw (Martin 1989, Lombardi & McCarthy 1991), Papago (Hill & Zepeda 1992), Catalan (Cabré & Kenstowicz 1995), Rotuman (McCarthy 1995), and Japanese (Tateishi 1989, Mester 1990, Poser 1990, Itô 1991, Itô and Mester 1992, 1996, Perlmutter 1992, Itô, Kitagawa, & Mester 1996).

In Yapese, the smallest licit independent word is a CVC syllable, and this clearly corresponds to the output of vocative truncation. The monosyllabism requirement is not surprising, but the demand that the word be consonant-final is. Since the language tolerates long vowels, it is somewhat surprising that CVV monosyllables are not permitted. We have already seen — for instance, in the case of Kamaiurá — that languages may place special requirements on word-final consonants. Such requirements, in our theory, are expressed purely melodically, via the mechanisms of association. That is, a nonvocalic melody element must be linked to the final mora in the minimal (bimoraic syllable) word. We show in section 2.4.3.1 that similar rules of association are needed even in a theory that has C/V skeleta and that ours is in fact a superior theory of their properties. Yapese extracts the entire melody, then associates with the σ template from left to right.

The Yup'ik case, which is closely analyzed in prosodic terms by Woodbury (1985), is a clear (and unique) example in which the morphology must make reference to a quantity-sensitive iambic foot. The patterns assumed by proximal vocatives correspond exactly to the complex requirements that the Yup'ik stress system must in any case place on this foot type — it is monosyllabic or disyllabic, it contains at least two morae, it must end in a consonant, and bimoraic syllables are permissible only on the right. In contrast with the complete generality of the template, the mode of association is somewhat idiosyncratic. Normally, association begins at the left edge, but occasionally it starts inside the word. Pairs like *Cup/Cupəl* show that both types of iambic quantity-sensitive feet can be associated with a single melody. The form *Akiuk* exhibits a compressed (that is, monomoraic) diphthong. This compression also fulfills the requirements of the language — full diphthongs are impossible in closed syllables.

In Afar, a minimal word (monosyllabic like Yapese) template is associated with the base melody from the left. The gerundial suffix *am* is attached to this truncated form, and the result is used as an independent word in a paronomastic construction. This is not reduplication of the usual sort, since it is evidently postsyntactic, but is rather a mechanism for creating cognate gerunds. (Afar also has the option of using an untruncated form in the same way.)

Finally, the case of Japanese is the richest we have yet seen. Poser (1982) carefully demonstrates that the bases of hypocoristics with suffixed *yaN* are composed of one or two bimoraic units. As in Eskimo, the mode of association is somewhat idiosyncratic, with most speakers confining their choices to one of the options reported. Nevertheless, it is clear that the requirement of bimoraicity can be fulfilled in several different ways without regard to syllabic structure.

Poser reports impressionistic evidence of a bimoraic rhythmic unit in Japanese which he calls the foot. The other data from this language, coming from two sorts of abbreviations, confirm this result. With very few exceptions, such abbreviations are also constructed from one or two bimoraic units. Even more compelling evidence for this conclusion emerges in a secret language of entertainers described by Tateishi (1985 [1989]). This secret language performs the following permutations:

(78) Japanese Secret Language

Base Form	Secret Form	
maneezyaa	zyaamane	'manager'
koohee	hiikoo	'coffee'
ippatu	patuiti	'a shot'
oNna	naaoN	'woman'
mesi	siimee	'meal'
hi	iihii	'fire'

As Tateishi observes, the secret language forms are all composed of exactly two bimoraic feet, regardless of the mora count of the original.⁴³ The skeleton of the disguised form, then, is simply FF, while the mode of association is obviously one of great complexity.

Zuuja-go

A comprehensive analysis of this secret language, with significant theoretical development, is presented in Itô, Kitagawa & Mester 1996.

The English truncated words are a type of templatic morphology based on the composition of minimality: $\min(\min(Wd))$. The minimal phonological word of English is the foot; it functions in the formation of echo words, as we show below. In truncated words, the template is the minimal foot: $\min(F) = \min(\min(Wd)) = \sigma$. English and Yup'ik truncations provide a nice contrast: the former is $\min(\min(Wd))$, therefore σ ; the latter is $\min(Wd)$, therefore F.

English has a large number of truncated words, which Jespersen (1928–) calls 'stump-words', that may appear alone or with an affix like *-er(s)*, *-ie*, *-y*, or *-o*. A few examples of the many hundreds of these appear in (79):

(79) English "stump-words"

rugby	rugger
pregnant	preggers
Bolshevik	Bolshy
Jonathan	Jono

Similar data, although without a regular morphological relationship, are found in English affective verbs in *-er*, like *patter*, *quaver*, *flicker*, *glisten*.

⁴³ There is one exception to this: trimoraic trisyllabic words like *piyano* become *yanopi*. Although there is no reason to doubt the accuracy of this observation, it is interesting that Osamu Fujimura, a native speaker of Japanese but not of this secret language, strongly felt that this must be a mistake.

The base of the truncated form, minus any affix, is invariably a single stressed syllable (= $\min(\min(Wd))$).⁴⁴ In no case does the truncated form contain more than one syllable (modulo the affixes), nor does it ever retain any consonants which could not be assigned to a minimal word template. Thus, *rugby* or *pregnant* cannot form the phonotactically permissible but morphologically ungrammatical affectives **rugber* or **pregners*. Furthermore, the assignment of melodic material to the σ (= W_{\min}) template is indifferent to the syllabification of the base, so the affective is *Bolshy* in spite of the fact that *Bolsh* does not constitute a syllable of *Bolshevik*.⁴⁵ In other words, the formation of stump-words is not an operation of truncation, but rather of assignment of melody to template. This is true cross-linguistically: truncation the phenomenon is not truncation the operation, but rather is association with a specified template. Finally, we note that the affixes appearing on these affective words all are stress-neutral, as we would expect of a morphological pattern that requires a form in the shape of a phonological word.

The mere volume of the forms and the ease with which they are coined suggests that this process is quite productive in English. Nevertheless, there are a few idiosyncrasies. Nicknames, but not other affective words, are subject to various neotenus segmental changes, like *Bobbie* from *Robert*. Association of the melody is normally from the left edge in, as we would expect from unmarked left-to-right association, but in a very few forms association begins at the stressed syllable: *tater* (<*potato*), *tec* (<*detective*).

A few instances of truncation invoke a prosodic constituent demonstrably different from the foot or minimal word. Both known cases involve taking reduction of the weakly-stressed member of a compound to its limiting case: truncation.

Truncation in Zuni (Newman 1965) applies to the left-branches of all compounds (80a) and to stems before certain suffixes (80b). The result of truncation retains only the initial (that is, stressed) consonant and vowel of the original:

(80)	Zuni Truncation		
a.	tukni	tu-mok ^w k ^w anne	‘toe-shoe = stocking’
	melika	me-k ^w iššo	‘Non-Indian-negro = black man’
	melika	me-ʔoše	‘Non-Indian-be:hungry = hobo’
	paču	pa-lokk’a-ak ^w e	‘Navajo-be:gray=Ramah Navajo’
b.		Familiar	
	k ^w alasi	k ^w a-mme	‘Crow’
	suski	su-mme	‘coyote’
	kuku	ku-mme	‘father’s sister’

It is evident that the truncation process is based on a monomoraic syllable template with LR association of the entire melody.⁴⁶ Can this template be derived from some higher-level unit of the language? Since words invariably have initial stress, there is no appeal to foot here. Nonfunction words appear to always be at least bimoraic, so the minimal word is also not in play. The Zuni monomoraic or core syllable does, however, correspond to the minimal root, and this seems a plausible constraint to place on the members of compounds or suffixed words.

Like Zuni, Madurese (Stevens 1968; Weeda 1986 [1987]) also displays truncation in connection with compounding, and also like Zuni Madurese truncation is anchored on the stressed syllable, in this case final.

⁴⁴ The syllabic character of stump-words has been independently noted by David Nash and Jane Simpson in unpublished work.

⁴⁵ Those with strong intuitions of ambisyllabicity may wish to contemplate examples with a different stress pattern. For example, *Altoona* would necessarily truncate as *Altie*, **Allie*.

⁴⁶ Newman (1965) has initial clusters in his analysis of Zuni, but these are restricted to C?. This idea has little merit and causes many problems, so I have reinterpreted these as glottalized consonants.

Truncation applies to the left branch of certain compounds (81a), to the left branch of one type of reduplication (81b), and spontaneously in certain words (81c):

(81) Madurese Truncation

a.	usap	sap-lati	'handkerchief' ('wipe'+ 'lip')
	uriŋ	riŋ-tua	'parents' ('person' + 'old')
	tuzhuʔ	zhuʔ-ənpul	'pinky' ('finger' + 'pinky')
	pasar	sar-suri	'afternoon market' ('market' + 'afternoon')
b.	bit	bit-abit	'finally'
	buwaʔ-an	waʔ-buwaʔ-an	'fruits'
	maen-an	en-maen-an	'toys'
	ŋastan-e	tan-ŋastan-e	'to hold'
	estre	tre-estre	'wives'
	chapphluk-an	phluk-chapphluk-an	'a noise'
c.	settoŋ	toŋ	'one'
	duwaʔ	waʔ	'two'
	enghi	ghi	'yes'
	uriŋ	riŋ	'person'

The template here is a simple syllable σ . As Weeda (1986 [1987]) notes, the introduction of tautosyllabic clusters into Madurese ('wives' and 'a noise' in 81b) is paralleled by a comparable development in the truncated forms. The σ template explains this; a segmental skeleton cannot. As in the other cases, the operation is not true truncation. Rather, association to the σ template begins with the left edge of the root-final syllable and proceeds until the phonemic melody is filled or the independently characterized positions in σ are exhausted.

The only roots of Madurese shorter than two syllables are function words (Stevens 1968:51), so neither minimal root nor a fortiori minimal word can be appealed to. The template here, then, is independent of higher-level prosodic units, and so rests directly on the syllable.

TEMPLATIC WELL-FORMEDNESS REQUIREMENTS

Languages frequently place templatic requirements on morphemes or derived forms of a particular class. These requirements are not actively enforced in the sense of generating alternations the way truncation does, but they exist passively in that all members of the class must conform to them. The by now familiar minimal word or root is a clear instance of this type, but in most cases the template is unmodified by the minimality predicate. For example, Indo-European root monosyllabism is expressed by a σ template which demands that all roots be exactly one syllable long, neither more nor less. A substantial subset of the English affective vocabulary involves a similar rule.

English echo words involve total reduplication of a (typically) nonoccurring base with some unsystematic changes in vocalism or consonantism: *jingle-jangle*, *helter-skelter*. Although this is not a regular or orderly domain of English morphology, it is nevertheless a very common and possibly productive one; Jespersen (1928–) observes that it is quite frequent, and Thun (1963) has collected over 4000 different examples from throughout the history of the language.

Inspection of these extensive data yields the following observations, which hold virtually without exception. An English echo word may be a word-level compound of two stressed syllables (*hob-nob*), of two disyllabic words of the form stressed-unstressed (*fiddle-faddle*), or of two trisyllabic words stressed-unstressed-unstressed (*higgledy-piggledy*). Occasionally the two halves of the compound differ in canonical pattern, but always within this range of possibilities: *plug-ugly*, *pitter-pat*, *kitty-cat*.

In sum, an echo word must be a compound of exactly two metrical feet, each of which constitutes a separate phonological word. This is equivalent to regarding them as compounds of two minimal words W_{\min} . English metrical feet are composed of a stressed syllable followed by zero, one, or two unstressed syllables (the

last derived by syllabic extrametricality at both junctural positions in the compound), which corresponds to the distribution of reduplicated echo words.

This formal requirement not only generates the occurring types but, naturally enough, excludes many nonoccurring ones. Echo words are impossible with an unstressed syllable preceding the foot (**banana-cabana*) or with more than one foot (**phalarope-kalatrope*).

Another example of this sort is provided by a class of Jamaican Creole affective words called iteratives. According to DeCamp (1974; see also McCarthy 1983b), iteratives are reduplicated words built on a monosyllabic template, to which is optionally added an unspecified (and therefore harmonizing) core syllable to indicate greater intensity or a specified *i* to mark jocosity:

(82)	Jamaican Iteratives	
	mak-mak	‘muddy’
	graŋ-graŋ	‘firewood’
	maka-maka	‘muddy (intensive)’
	priiti-priiti	‘very pretty’

Potential iteratives not conforming to the monosyllabic pattern are excluded (e.g., *kyerfl-kyerfl*). DeCamp not only collected a very large set of actual iteratives, but also went so far as to experimentally confirm the boundaries of the phenomenon by testing hypothetical iteratives with five informants. Thus, the generalization about canonical pattern is confirmed by quite careful scrutiny.

TRUE TEMPLATIC MORPHOLOGY

The final case is represented by the classic templatic systems, those in which the template directly expresses the morphological possibilities of the language. We discuss here Semitic and the templatic formation of the habitative in Cupeño.

Semitic

Proposals to reduce the Classical Arabic templatic system to prosodic structure have been pursued before (Levin 1983, Lowenstamm and Kaye 1986, Yip 1983), but always with a skeletal tier of segment-sized units. We will show that the segmental skeleton is entirely superfluous, and we will develop several novel arguments for a prosodic characterization of this system, considering fully the consequences of our moves.

The basic data, presented in the CV notation, are contained in (83):

(83)	Arabic Templates	
	a. Verbal Templates	
	CVCVC	CVCCVC
	CVVCVC	CCVCVC
	CCVCCVC	CCVVCVC
	b. Nominal Templates	
	CCVC	CVCC
	CVCVC	CVVCVC
	CCVVC	CVCVVC
	CVCCVC	CVVCVC
	CVCCVVC	CCVCCVVC
	CVVCVVC	CCVCVVC
	CCVVCVVC	

These skeletal patterns exhaust those assumed by canonical, unaffixed nouns and verbs. There also exist noncanonical nouns — these generally fail to participate in Arabic root-and-pattern morphology or behave somewhat idiosyncratically when they do.

More on Semitic Morphology

An account of Arabic nominal and verbal template-forms that aims at thoroughness is presented in M&P 1990b. It is further refined in Prince 1991, McCarthy 1993, and M&P 1991b. (The account of Arabic plural templates in M&P 1990a should also be mentioned.) Other relevant literature on the morphology of various Afro-Asiatic languages includes Bat-El 1989, 1992; Dell & Elmedlaoui 1992; Gafos 1996; Guerssel & Lowenstamm 1994; Hayward 1988; Hoberman 1988; Inkelas 1990; Lowenstamm & Kaye 1986; Moore 1989; Prince 1991; Sharvit 1994; Yip 1988.

All indications in Arabic point toward a split between monomoraic CV syllables and bimoraic CVC and CVV syllables. The stress system divides up light and heavy syllables along these lines, and a corresponding distinction is made in the otherwise unrelated system for scanning verse.

We must also recognize a place for peripheral unsyllabifiable consonants. Such consonants are a consequence of peripheral extraprosodic syllables in the skeleton. These syllables, we stipulate, have exactly one consonant melody associated with them; they will develop vocalism only when they cease to be peripheral and therefore extraprosodic (or, ultimately, in the postlexical phonology). This vocalism is supplied either by affixes or ultimately by epenthesis. We will say a bit more about these syllables below.

A syllabic characterization of the Arabic skeleta, using the moraic distinction between light and heavy syllables and extraprosodicity defined in this way, is as follows:

(84)	Arabic Skeleta Prosodically	
	Syllabic Skeleton	Corresponding CV-skeleta
	σ (σ)	CVCC
	(σ) σ	CCVC
	(σ) σ (σ)	CCVVC
	σ_{μ} σ	CVCVC
	$\sigma_{\mu\mu}$ σ	CVVCVC, CVCCVC
	σ_{μ} σ (σ)	CVCVVC
	$\sigma_{\mu\mu}$ σ (σ)	CVVCVVC, CVCCVVC
	(σ) σ_{μ} σ	CCVCVC
	(σ) $\sigma_{\mu\mu}$ σ	CCVCCVC, CCVVCVC
	(σ) $\sigma_{\mu\mu}$ σ (σ)	CCVCCVVC, CCVVCVVC
	(σ) σ_{μ} σ (σ)	CCVCVVC

It should be noted that the weight (mora count) of the last metrical syllable in each skeleton is unmarked because these syllables are invariably heavy. We will bring this up again below.

There are many results that follow from this reanalysis of the Arabic skeletal system.

1. This approach permits us to require that Arabic skeleta in general are subject to a minimum size of one metrical syllable and a maximum size of two metrical syllables. The former is not somehow indendently necessary — there are a few noncanonical nouns with no syllables, like *bn*. The latter follows from general conditions of locality imposed on counting rules, as described in section 1. Verbs are subject to more stringent constraints: they are minimally and maximally disyllabic.
2. We can extract out the generalization, already noted, that the last metrical syllable is always bimoraic. That is, $\sigma \rightarrow \mu\mu / ___$.
3. Unsyllabifiable sequences are limited to peripheral position, a consequence of the usual constraints on the distribution of extraprosodicity. The corollary to this is that, modulo the extraprosodic elements, Arabic skeleta are well-formed sequences of syllables. This is not a

trivial result; since Classical Arabic and most dialects have epenthesis rules that would regularize even template-internal unsyllabifiable strings, the underlying well-formedness of the template demands an explanation. Moreover, as we noted in section 1, medial unsyllabifiable segments could be used to cook the results of left-to-right association.

4. Subject to these other three requirements, the occurring skeleta are a result of the free concatenation of the representational vocabulary (heavy and light syllables, extraprosodicity). There are no gaps: all and only the elementary patterns generated by free concatenation function in the morphological system.

5. There is no true skeletal contrast between CVC and CVV syllables; the apparent differences are accounted for by melody-to-skeleton association rules of great generality. To prove this, we distinguish two cases. The last metrical syllable, always heavy, is also always CVC if it is truly the last syllable. If it is followed by an extraprosodic syllable, it is CVV except in when it is also initial (that is, in the template $[\sigma (\sigma)]$). The language simply displays no contrast in these cases; the nouns that would require such a contrast (*gaaz* ‘gas’, *ʔusquff* ‘bishop’) are transparent loans, extraordinarily rare, and thoroughly noncanonical. Thus, it is a simple matter to describe the contexts in which a CVC syllable occurs; these contexts trigger a rule of root-to-skeleton association, linking the rightmost root consonant with some unit of the skeleton.

Likewise, there is no CVC/CVV contrast in other syllables (those marked as bimoraic in (84)). The distinction between CVV and CVC syllables internally is accounted for by rules of somewhat lesser generality. In particular, the verbal skeleton CVCCVC is not freely available — it is the result of an association rule deriving medial gemination (*kattab*) that any analysis requires, or it arises under the force of the requirement that all root consonants be associated with some prosodic element (as in the quadriliteral verb *daHraj*).⁴⁷

6. As we noted in section 1, the apparent restrictions on Arabic skeleta that would follow from segment counting actually follow from syllable counting and the relatively simple independently motivated syllable structure of this language. The proof of this claim is the evidence adduced in McCarthy (1984c) from Modern Hebrew. The richer syllable structure of Modern Hebrew is reflected in the richer possibilities for disyllabic templatic verbs: *ʔisknez* ‘make Ashkenazic’, *šlimper* ‘make sloppy’, *stingref* ‘take shorthand’. There is no difference between the cognate templates in Classical Arabic and Modern Hebrew; the sole difference lies in the licensing of tautosyllabic consonant clusters in the latter.

7. Arabic consonants linked to extraprosodic syllables do not have the same properties as truly unsyllabified consonants. In Cairene Arabic, triconsonantal clusters are normally resolved by epenthesis after the second consonant: VCCiCV. As expected, initial clusters in loans are split in the equivalent way, so that the epenthetic vowel also lodges in an open syllable: *sibirtu* ‘spirit’, *bilastik* ‘plastic’. But initial clusters of words formed on templates (that is, all words except loans) undergo epenthesis in a way otherwise unprecedented in the language: *ʔjtama9* ‘he met’. The posited linking to an initial extraprosodic syllable distinguishes this sort of epenthesis from the more general phenomenon observed in loans and other clusters.

These arguments lead to a single conclusion: all vestiges of segmental structure, cast as C/V, X, or whatever, must be removed from the Arabic skeleton. The maximum generality and regularity of skeletal form is achieved by limiting the descriptive vocabulary to syllables, moraic annotations, and extraprosodicity.

⁴⁷ A comparable point has been made by Levin (1983) and Broselow (1984).

Cupeño

The Uto-Aztecan language Cupeño requires a foot template to characterize a morphological category called the *habilitative* (McCarthy 1984c). *Habilitatives* are confined to one of the forms shown in (85), where the shape of the *habilitative* is determined in part by the shape of the base:

(85) Cupeño *Habilitative*

	Verb Stem	<i>Habilitative</i>	
a.	čál	čáʔaʔal	‘husk’
	təw	təʔəʔəw	‘see’
	həʔəp	həʔəʔəʔəp	‘hiccup’
	kəláw	kəláʔaʔaw	‘gather wood’
b.	páčik	páčíʔik	‘leach acorns’
	čáŋnəw	čáŋnəʔəw	‘be angry’
c.	pínəʔwəx	pínəʔwəx	‘sing enemy songs’
	xáləyəw	xáləyəw	‘fall’
d.	čí	číʔ	‘gather’
	hú	húʔ	‘fart’
	ʔáyu	ʔáyu	‘want’

In (85a, b, c), the stressed syllable of the *habilitative* is followed by two unstressed syllables. In (85a), both of these posttonic syllables contain λV sequences, where V is a copy of the tonic vowel. In (85b), the final syllable contains a single such λV sequence, and V copies the vowel of the immediately posttonic syllable. And in (85c), there is no copying at all. These three types correspond directly to the position of stress in the original: oxytone, paroxytone, and proparoxytone respectively. Vowel-final roots like those in (85d) differ from the others — they have no copying and remain unchanged (modulo phonological insertion of λ after final stressed vowels) in the *habilitative*.

The shape-invariant in the Cupeño *habilitative* is a trisyllabic, consonant-final foot at the end of the word. Material preceding the stressed syllable is irrelevant; one may say that it is extraprosodic for the purposes of *habilitative* formation. Although trisyllabic feet are not part of the inventory of primitive foot types, since this trisyllabic foot is necessarily word-final it can be derived from a disyllabic foot plus final syllable extrametricality. This derived foot constitutes the Cupeño *habilitative* template:

(86)

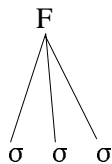

The analysis also requires one rule of melody-to-skeleton association, a rule linking the rightmost consonantal melody unit to the rightmost syllable of the template. This rule has three partly independent functions in Cupeño. (1) It is indispensable to the association of the rest of the melody, as we will see. (2) It expresses the generalization that all templatic *habilitatives* of the language are consonant-final. (3) It blocks templatic *habilitative* formation in vowel final roots like those of (85d).

With this template and this consonant association rule, we derive some relevant examples as follows:

(87)

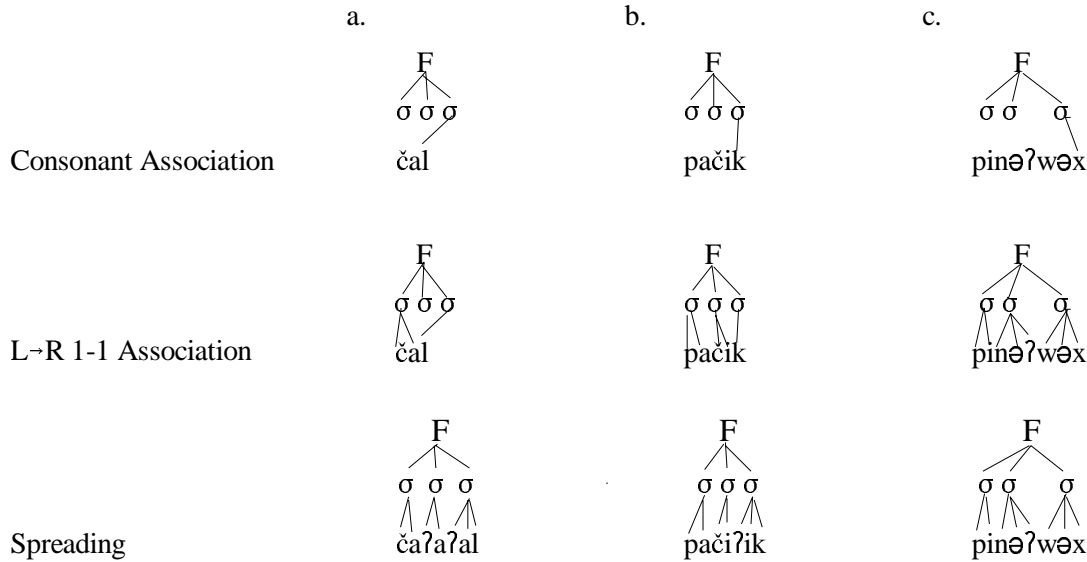

Consonant association first establishes a rightward bound for spreading — it is therefore needed independently of its role in describing the canonical pattern of Cupeño habitatives. LR association of the other elements of the melody establishes a leftward bound of spreading, and then the vowel spreads to satisfy the trisyllabic requirement of the F skeleton. Cupeño, like many languages, independently requires insertion of *ʔ* to resolve vowel-initial syllables; application of that rule in (87a, b) derives the correct results.

Other Templatic Morphology

This type of morphology is also found in several Penutian languages — Miwok (Freeland 1951; Broadbent 1964; Bullock 1990; Crowhurst 1991a, 1992b; Goldsmith 1990; Lamontagne 1989; Sloan 1991; Smith and Hermans 1982; Smith 1985, 1986), Yokuts (Newman 1944; Archangeli 1983, 1984, 1991; Steriade 1986; Prince 1987, 1991), and Takelma (Sapir 1922; Goodman 1988; Lee 1991).

3. Other Issues in Templatic Structure

The consequences of a skeletal theory are not confined to shape-invariant morphology; they reverberate down through the phonology. We address here four major topics of relevance to the skeleton: the status of syllable-internal structure, prespecification, the analysis of contour segments like affricates, and the relation between a prosodic skeleton and phonological rules.

3.1 Syllable-internal Structure

The conception of syllable-internal structure that we have assumed so far in our discussion is nearly minimalist beyond the recognition of the light/heavy distinction encoded as mora count; nothing in our results has hinged on this aspect of the representations. We can imagine, in complete conformity with the rest of our argument, several different views of intrasyllabic representation. Consider the following different illustrations of the English bimoraic syllable *plane*, that is [ple:n]:

(88)

a.

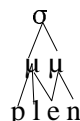

b.



c.

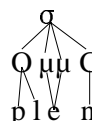

The theory in (88a) represents one traditional view of moraic structure. The melodic elements of a syllable are exhaustively parsed into morae. But since morae are invariably parts of syllables in our conception (that is, there are no languages without syllables, as a consequence of the prosodic hierarchy), our proposals are equally compatible with (88b), in which each mora is associated with exactly one melodic element. Here, the moraic structure designates only weight; it is syllabic structure that provides a locus for melodic units that do not contribute to weight. In theory (88c), the nonmoraic melodies of the syllable are gathered up into labeled categories, Onset and Coda, providing a somewhat greater degree of expressive freedom than (88b). Adoption of theories (88b) or (88c) provides another option: we might choose to assume that they are subject to a general constraint of Uniformity of Linking, in which no melodic element may bear simultaneous associations to two distinct levels of prosodic structure (thus ruling out, for example, a consonant which is simultaneously a μ and a Coda).

Moraic Theory

The literature on this topic that has appeared since 1986 is much too large to cite here, but a few studies should be particularly mentioned: Hayes 1989, Itô 1989, Sherer 1994, Steriade 1993, Zec 1988. For our own proposals about morafication, see M&P 1988.

The representations in (88a, b, c) are all natural conceptions of intrasyllabic structure in a theory which gives primacy to the mora. A far less natural one would include a Rhyme constituent as well, conceived as follows:

(89)

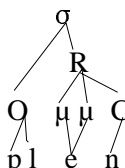

In this case, the fact that reference to the internal structure of syllables in prosodic morphology is restricted to mora count is completely surprising, since moras are not represented on a tier directly adjacent to σ . In all the other conceptions of intrasyllabic structure, the mora is the most immediately available modification of the syllable; here it is not. (89), then, is in no way a natural option in our theory.

We are, then, in agreement with Clements and Keyser (1983) in rejection of the Rhyme as the primary constituent of the syllable and in fact as having any role in syllabic organization. We shall evaluate the evidence for intrasyllabic structure as it bears on this question.

Intrasyllabic Structure

Some of the points made below can also be found in Davis 1985b, which the author brought to our attention after this document was first circulated.

The primary argument for a rhyme/onset division comes, of course, from considerations of syllable weight, particularly as they apply in stress systems. The branching of the rhyme or of a subordinate subsyllabic constituent, called the nucleus, has been taken in most accounts of stress to record the weight of syllables. From our perspective, this task is better left to the mora. In particular, as Prince (1984) has demonstrated, the notion of ‘branching’ that is crucial to such accounts is empirically inadequate. (V. section 3.4 for further discussion.)

It is profitable to explore the systematic cross-linguistic variation in what causes a syllable to count as heavy. In Lardil, only long vowels figure in the computation (see section 2.1). In Kwakiutl, as Bach (1975) shows, long vowels and VR sequences, where R is a sonorant, count as heavy.⁴⁸ And in Arabic, heavy syllables are just the class VV and VC (C a consonant or glide). In our interpretation, this brief paradigm explores the range of what constitutes a single mora; it obviously corresponds to the familiar sonority hierarchy (cf. Prince (1983)). We note two other consequences. Since monomelodic long vowels must branch from melody to mora level (simply to be represented, if we impose Uniformity of Linking), long vowels must be heavy. Languages which make no distinctions of syllable weight are determined at the syllable-mora interface: σ is a μ .

Consider, too, the usual failure of onsets to participate in computations of syllable weight. In onset/rhyme theories, this result is normally stipulated by some combination of a theory of the onset/rhyme division and an assumption about projection of rhymes or nuclei in any syllable-weight computation. It falls out trivially from any of the theories in (88). We must in any case say that onsets are nonmoraic in order to enforce the requirement that syllables have onsets (cf. Hyman (1985)); all the representations in (88) respect that requirement. It follows, then, that onsets have no role in determining the weight of syllables.⁴⁹

The sole other major source of evidence for the rhyme/onset distinction has been the statement of distributional regularities within the syllable. It is claimed that subsyllabic constituency governs the domain of intrasyllabic cooccurrence restrictions. Such restrictions fall into two types. On the one hand, they are quite clearly interpretable as limits on syllable weight, as is the case with the familiar prohibition of CVVC syllables (that is, all postnuclear elements must be moraic, and syllables contain no more than two morae) or the more baroque instantiations of this effect in English. Restrictions of this sort fall clearly within the purview of the melody/mora or the mora/syllable mapping. More general cooccurrence restrictions within the syllable are to be interpreted as effects of the distribution of sonority within the syllable, a distribution that shows no particular discontinuity at the putative onset/rhyme division.

There is also a small literature invoking the rhyme as the domain of some phonological process. Effects of this sort are inherently more compelling as evidence than the statement of static distributional regularities, but here the argument stumbles for a different reason. Rhyme-domain phonological rules are typically trivially reformulable without reference to rhymes; we know of no examples where the absence of a rhyme would substantially complicate the statement of several well-supported regularities within a language which are not

⁴⁸ With Bach (1975), we take Kwakiutl glottalized resonants to be nonsonorant.

⁴⁹ Pirāhá (Everett and Everett 1984) is claimed to display onset sensitivity in stress assignment of a very different type: a voiceless onset attracts the stress. Interestingly, the more obviously structural case of onset sensitivity in Western Aranda (Davis 1985a) comes from a language in which the requirement that syllables have onsets seems to be nearly suspended.

simply a matter of moraic syllable weight. This is not an unreasonable requirement; it is in fact precisely the test to which syntactic constituency has been put for more than thirty years.

The only case known to us in which a bare rhyme has been proposed as a reduplicative affix is Tübatulabal (Voegelin 1935). Levin (1983) has argued that this language marks the telic form of verbs by prefixation of a rhyme constituent. A fraction of the facts as reported by Voegelin follow:

(90)	Tübatulabal Reduplication	
	Atelic	Telic
	tIk	ItIk
	ela	eʔela

That is, a copy of the vowel in the first syllable is prefixed to the base, for which rhyme reduplication makes eminent sense, since it eschews copying of the initial consonant. Tübatulabal reduplication also has a number of complications the analysis of which we postpone: vowel length in the copy is subject to complex permutations, tautosyllabic diphthongs copy only their first vowel, and nasals copy before voiced stops even though the language licenses a wide variety of clusters (preventing the sort of analysis given to Southern Paiute in Marantz (1982)). These factors ultimately require a heavy syllable $\sigma_{\mu\mu}$ prefix, but our concern at this point is with the failure of the onset to copy.

A superior analysis of this phenomenon is possible which makes no reference to the rhyme. The transcriptions in (90) are at odds with the description in Voegelin (1935) and Swadesh and Voegelin (1939) in one major respect (cf. Heath (1981), McCawley (1969), Kenstowicz (1977)): there is an initial glottal stop in words written as vowel-initial. Thus, these forms should be recast as follows:

(91)	Atelic	Telic
	tIk	ʔItIk
	ʔela	ʔeʔela

In other words, the minimal reduplication in Tübatulabal is ʔ plus a copy of the first vowel.

Tübatulabal Reduplication

In M&P (1994ab), we propose that Tübatulabal reduplication is an instance of *emergence of the unmarked* (M&P 1994a) in Optimality Theory. The idea is that structural complexity — that is, markedness — can be avoided by inexact copying, and is in Tübatulabal, where the initial consonant is not copied. Nonetheless, ONSET must be obeyed, so the least marked onset, the glottal stop, emerges in the reduplicant. On the general characteristics of fixed segmentism in reduplication, see Alderete *et al.* 1996. For another view of Tübatulabal reduplication, see Crowhurst 1991ab.

Depending on details of the theory of prespecification, we can suggest two possible accounts of Tübatulabal that are compatible with our approach and that do not involve reference to the rhyme. On the one hand, we can treat the affix as a heavy syllable with prespecified ʔ:

(92)

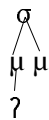

Only the vowel melody of the base links with this to complete the bimoraic syllable; it is unambiguously linearized as $\mathcal{N}V$.⁵⁰

Alternatively, in light of the pattern of total reduplication minus an initial consonant evidenced in (102c), we could appeal to a detachment rule of the sort described in section 3.2 to delink the base melody from the affixal σ_c . Then a general default rule of the language, reflecting the requirement that syllables must have onsets, inserts $\mathcal{?}$. In either analysis, the mechanism we appeal to is a conventional syllabic template with prespecification or its equivalent.

The advantage of prespecification over rhyme affixation is that the former makes a great deal more sense of the historical basis of this affix. The other Uto-Aztec languages clearly have some form of initial syllable (core or bimoraic) reduplication; Tübatulabal with rhyme reduplication seems a strange aberration in this context. No mechanism known to us would cause a syllable to be reinterpreted as a rhyme.

In the prespecification analysis, contemporary Tübatulabal emerges as a straightforward case of analogic leveling. The copied initial glottal stop of verbs beginning with this segment metastasized to all verbs of the language: *ʔela* : *ʔeʔela* :: *ʔik* : *ʔʔik*. This sort of analogy is undoubtedly a common if not exclusive source of apparent prespecified elements. It may have been helped along by some dissimilatory effect, although we can find no independent evidence for this.

Other literature invoking the onset or rhyme for the statement of morphological regularities is limited to discussions of language games. There is a class of language games in English and German which seem to demand these subsyllabic constituents:

(93) Language Games

a. Chicken Language

English

Secret languages are fun

sihiləfi krəthətʌfət læŋhæŋləfæŋ gwɪlhɪləfɪj əzhəzləfəz arharləfar fənhənləfən

German

Ein gutes Wort findet einen guten Ort

Einheinlefein guhulefu testheslefes worthortlefort finhinlefin dethetlefet eiheilefei
nenhenlefen guhulefu tenhenlefen orhortlefort

b. Goose language

Ich lieb' dich aus Herzensgrund

Ichicherfich liebeberfieb dichicherfich ausauserfaus Herzerzerfers
grundunderfund

c. Bern Matteenglish

und	inde	'and'
Bänne	innebe	'small cart'
Benu	inube	'Bernard'
Blofer	iferble	'pencil'
bschummle	immlebsche	'deceive'
Chrampf	impfchre	'work'
Gschtöös	isgschte	'socks'

⁵⁰ The long vowel then shortens by an independently motivated rule in the cited examples. This approach involves treating the glottal stop as underlying, at odds with Voegelin's (1935) theory of organic and inorganic glottal stop. The organic glottal stops alone are moraic. Heath (1981) argues vigorously against this idea, it is in any case incoherent, and it is clearly inconsistent with Voegelin's later analysis in Swadesh and Voegelin (1939).

d. Pig Latin

dog	og-day
trip	ip-tray
street	eet-stray

e. Abi-dabi

language	labang guabage
street	strabeet

A naive conception of these language games is as follows. In the Chicken and Goose languages, the rhyme is copied with constant monoconsonantal onsets. In Matteängrisch and Pig Latin, the onset is postposed and a constant vowel is added. In Abi-dabi and similar languages, a constant VC sequence intervenes between onset and rhyme.

Language Games

There is a very substantial recent literature on language games. See: Bagemihl 1988, 1989ab, Bao 1990, Chiang 1992, Duryea 1991, Hammond 1990, Itô, Kitagawa, and Mester 1992, Plénat 1985, Tateishi 1989, Turner & Breen 1984, Vago 1985, Yin 1989, Yip 1982, and the contributions to Plénat 1991. Bagemihl 1989b and Plénat 1991 also include comprehensive bibliographies.

Cross-linguistically, there is a systematic difference between language game prosody and normal prosody. In games of the Goose, Chicken, and Abi-dabi types, each syllable of the original form becomes a separate phonological word of the derived form, with the characteristic prosody of a word. Moreover, in the Goose and Chicken varieties, each syllable of the **derived** form is a separate phonological word: cf. *games-hames-le-fames*, with a succession of syllables that are impossible word internally. (The syllable *lə* ultimately cliticizes.) No remnant of the prosody of a single word survives in the language game forms of a polysyllable. It follows, then, that the language game is operating separately on virtual words like *se* and *cret*, the individual syllables of the real word *secret*.

Under this conception, Chicken language (or, mutatis mutandis, Goose language) is essentially word reduplication with a fixed initial consonant, *h* in one copy and *f* in the other. The fact that the ‘word’ coincides with a syllable of the original is something that must be said in any case. There is no rhyme reduplication; the mechanism is formally indistinguishable from the treatment of echo words in section 3.2. Abi-dabi is a different story. Paralleling games like Abi-dabi or Alfalfa (*stralfet*) in which a fixed VC₁ sequence is inserted before the vowel of each virtual word, there are games in which a fixed C₁V sequence is prefixed (or suffixed) to each virtual word: Texas Spanish *rosa* → *kutiro kutisa* (Sherzer 1982). The explanation for this distribution is obviously syllabic: the infixes lodge in the only place where they are licensed syllabically, so only vowel-initial infixes are possible in post-onset position. This generalization is observed with perfect regularity in all of the more than 30 relevant language games known to us. It would obviously be a mistake to stipulate the placement of the infix by making direct reference to the onset. Moreover, this parallels the behavior of real infixes noted in section 2.3. Reference to subsyllabic constituency in the rule of infixation would simply fail to capture this regularity, which derives in a straightforward way from independent syllabic well-formedness constraints.

The remaining examples, Pig Latin and Matteängrisch, are apparent instances of transposition language games. We propose that in fact they involve reduplication with extensive prespecification. In all cases known to us where transposition can be distinguished from reduplication empirically, reduplication is clearly the mode by which apparent transposition is effected. Yip (1982) demonstrates this compellingly for Chinese secret languages: prenuclear glides appear in both original and copy, although the standard analysis treats this as an instance of rhyme transposition. The Japanese secret language in (78) is shown by Tateishi (1985 [1989]) to necessarily involve copying rather than transposition; the behavior of *oNna* and *hi* is otherwise inexplicable. And in Cuna (Sherzer 1970, 1975), a classic case of a transposing language game, the game form *bansab* from underlying

/sappan/ (surface *sapan*) cannot be accounted for in terms of transposition without giving up the monomelodic analysis of geminates in this language that is required independently.⁵¹ Monomelodic geminates are, however, entirely compatible with apparent transposition via reduplication. Quite apart from these empirical considerations, the identification of apparent transposing language games with reduplication yields theoretical fruit: transposition is unprecedented in real morphology, while reduplication is common. All other operations performed by language games are paralleled in morphology. By treating transposition as reduplication, we remove the one remaining bar to full concert between the two domains, with language games clearly parasitizing the morphological resources provided by linguistic theory.

Thus, although we have no direct evidence that Pig Latin is reduplicative, we are compelled by the logic of the theory to treat it that way nevertheless. Close inspection of the data reveals its character. The game form is composed of two phonological words. The prosody clearly reflects this, and the treatment of words like *eat*, in Pig Latin phonetically *ʔiytʔ ʔey* or *ʔiyD ey*, with *t* allophony characteristic of word junctures, confirms the observation.⁵² If the result were a single phonological word, we would expect *eat* and *tea* to merge in Pig Latin as *ʔiyt^hey*.

It follows, then, that Pig Latin is simply word reduplication, with a result composed of two phonological words, the second of them minimal (that is, a monosyllabic foot). The characteristic transformations of these two phonological words — the first lacking initial consonant, the second monosyllabic with fixed *ey* — are paralleled closely in the other cases of total reduplication, particularly echo words. The fixing of the initial consonant(s) as 0 is identical to the union of the phenomena in (102a) (*table-shmable*) and (102c) (*amne-samne* from *samne*). The fixing of the vocalism in the second copy is comparable to Tzeltal total root reduplication (Berlin 1963): *b'ah, b'ahbu* 'strike with hammer'; *t'os, t'ostu* 'snap fingers'. The mechanisms for apparent prespecification in these and comparable cases will be identical to those developed for echo words.

What we have seen, then, is that the need for reference to rhymes and onsets as skeletal units is nonexistent, given an analysis of the language game data in the light of independently motivated properties of authentic morphology.

3.2 Prespecification?

Prespecification is the mechanism in McCarthy (1981) and Marantz (1982) by which templatic or reduplicative morphemes have invariant melodic material. Prespecification may be complete or partial. In the former case, the prespecified melody blocks association of or, nearly equivalently, takes precedence over any melodic element contributed by the base. In the latter, one or more features, constituting less than a complete segment, take precedence over only the same features of the base melody, yielding, for example, a reduplicated vowel that is invariantly high but whose other properties are determined by the quality of the original.

Prespecification was developed in the context of a skeletal theory with segment-sized units; it therefore has considerable potential that no language exploits. Consider, for example, the familiar CCVC reduplicative prefix with prespecification of the second consonant as *r*:

⁵¹ Independent evidence for monomelodic geminates in Cuna comes from several sources. First, a rule changing *k* to *y* preconsonantly is blocked just in case *k* is geminate. Second, many Cuna geminates result from rules of assimilation, properly formulable only as autosegmental spreading rules. Third, Cuna simplifies triconsonantal clusters preferentially by degemination. Fourth, Cuna has a number of rules applying only to geminates. Fifth, Cuna apparently restricts the distribution of syllable-final obstruents except when they are geminate. This conjunction of properties is inexplicable unless the language has monomelodic geminates.

⁵² Some Pig Latinists introduce a glide for vowel-initial words only — *ʔitʔwey* — exhibiting the kind of context dependence we also see in echo words. Cf. section 3.2

(94) r
 |
 CCVC

This yields an unattested pattern of reduplication like *BRAD-badupi*, *RAD-adupi*, *BRAD-bladupi*. Similar cases involving other consonant positions or vowels can be easily multiplied.

Two other problems lurk behind prespecification, although they are not intimately tied to segmental skeleta. First, there is preunderspecification — the fact, to be demonstrated below, that some cases of melodic invariants in reduplicative affixes are the result of a lack of copying rather than the blocking of association by a prespecified element. Second, there is a large class of phenomena — also described below — in which total reduplication exhibits melodic invariants. Since total (root, stem, word) reduplication cannot in general stipulate a segmental skeleton even in a theory with such a skeleton, there are no positions with which to link the prespecified melody.

Consider first the case of Yoruba reduplication. Yoruba prefixes a *Ci* copy of a verb to derive a gerund:

(95) Reduplication in Yoruba

lo	lilo
du	didu

In Marantz (1982), the reduplicative prefix is analyzed as CV, with V prelinked *i*. This analysis appears unexceptionable.

But there are several other interesting points about Yoruba reduplication. First, since verbs are invariably of the pattern CV (Pulleyblank 1983:120),⁵³ CV reduplication is equivalent to total reduplication. In fact, a CV reduplicative skeleton merely recapitulates the Yoruba verb canon, a canon that the grammar must state in any case. Since, as we show below, prespecification is impossible with total reduplication, the sole reason for the redundant specification of a CV affix in this case is to provide a V slot to which *i* is linked.

The second point of relevance is that *i* is the default vowel of Yoruba, as demonstrated by Pulleyblank 1984 [1988]. From Pulleyblank's results, it appears that there is no evidence for *i* anywhere in the lexical phonology — it must be unspecified, to be introduced by a default rule at the end of the lexicon. Prespecification of a default vowel is plainly impossible: default vowels have no features to preempt those of the copied melody.

A third point involves tone. The prefix in the Yoruba reduplicated verb has invariant high tone — a case of classic prespecification (but of the whole root, not of a single vowel), since the Yoruba default tone is mid. But total reduplication⁵⁴ of nouns, which has a distributive meaning, displays a situation in which the first tone of the base spreads leftward onto the prefixed copy (high and low tone are marked in the familiar way, mid tone is unmarked):

(96) Total Reduplication Yoruba

àgbà	àgbààgbà	'elder'
òru	òròòru	'evening'
ègbé	ègbèègbé	'side'
osù	osoosù	'month'
ogba	ogboogba	'equal'
alé	alaalé	'evening'

⁵³ The second example in (95) is cited in the Yoruba orthography as *dun* by Marantz (1982). The final *n* is not a segment (since it cannot bear tone), but rather the orthographic sign of vowel nasalization. Yoruba does have syllable-final, tone-bearing nasals, but they are not possible in verb roots.

⁵⁴ Although this is sometimes described as VCV reduplication, the canonical Yoruba noun is itself VCV, so total reduplication is clearly what's involved. The canon is quite forceful; noncanonical nouns reduplicate according to the canon too.

These examples, from Akinlabi (1984: 198), exhaust the tonal patterns of canonical Yoruba nouns. The tone of the copy is derived by leftward spreading of any tone on the initial syllable of the base, or, if none (in the case of mid tone), by application of the default rule. In noun reduplication, the tone of the base cannot be copied.

This situation is rather common in reduplication in tonal systems — sometimes the tones copy, sometimes they are preempted by a specified tone, but often the tones do not copy, and we find instead either spreading or the application of a default rule.⁵⁵ The behavior of the vocalism in Yoruba root reduplication shows that this failure to copy is not limited to tone. Prespecification cannot stop something from copying — it only overrides things that do. The corollary: you cannot prespecify something as nothing.

The only solution to the Yoruba noun paradox is the one provided by Akinlabi (1984): the tonal tier does not copy, and therefore it is unavailable for association. We propose that each reduplicative affix may stipulate that certain tiers cannot copy (making reduplication of all tiers the unmarked case). This has the smell of brute force; the fragrance improves when we look at nontonal cases.

Tone

On tone in reduplication, see Walsh 1992, Pulleyblank 1994, and Carleton & Myers 1994.

We turn back to the problem of *i* in Yoruba verb reduplication. If vowel and consonant melodies are represented on separate tiers, and if this reduplicative affix stipulates against copying the vocalic tier, we obtain the desired result: the vocalism does not copy, but rather awaits the default rule. This is not the morphologically governed segregation of vowels and consonants of Semitic. Rather, it is the conception of segregation in Prince (forthcoming) — just as in traditional phonetics, distinctions in vowels and consonants are expressed by disjoint predicates. The tongue height and backness of vowels is primitively separate from the articulator and point of articulation of consonants. It is not so much vowels and consonants that are on separate tiers as the features distinguishing among vowels and among consonants that are segregated.

Considerations of the fine structure of featural geometry naturally arise in connection with the discussion of contour segments in section 3.3, but they also are important in the treatment of the partial prespecification phenomenon.

Fixed *i* in Yoruba Reduplication

In more recent work, we pursue a somewhat different account of the fixed *i* in Yoruba that still preserves the idea that it is a default segment. Falling under the same general analytical rubric as the fixed *ʔ* in Tübatulabal (see comment box on p. 58), Yoruba *i* is an *emergent* unmarked property of the reduplicant. See M&P 1994ab, 1995b for discussion. On the general characterization of unmarked segmentism in reduplicative affixes, see Alderete *et al.* 1996.

In a similar way we account for the pattern of apparent partial prespecification in Akan. Although we have consulted the major source on Akan reduplication, Schachter and Fromkin (1968), our understanding of this language has considerably benefited from the treatment in Lee (1984).

In subsequent discussion, we shall abstract away from certain irrelevant properties of Akan phonology. Since Akan vowels harmonize in [tense], and since the distribution of this feature has no bearing on the facts of reduplication, we shall not indicate the tenseness distinction.

With Lee and Clements & Keyser (1983), we assume that the mora in Akan is the minimal unit that can exhibit a tonal contrast. Akan reduplication appears to bifurcate into two quite different types depending on the

⁵⁵ We are grateful to Scott Myers for discussion of the behavior of tone in reduplication.

mora count of the base. The reduplication rule is applied to verbs to make iteratives, and may freely apply to its own output:

(97) Reduplication in Akan

a. Monomoraic Base

H tone	LH tone	
ba	biba	‘come’
daŋ	dinnaŋ	‘apply to’
pam	pimpam	‘sew’
kaŋ	kiŋkaŋ	‘count’
doŋ	dunnoŋ	‘soak’
seʔ	siseʔ	‘say’
soʔ	susoʔ	‘light’
haw	hihaw	‘trouble’
sow	susow	‘catch’
fer [feri]	fifer [fiferi]	‘swing’
pir [piri]	pipir [piperi]	‘go along’
sor [sori]	susor [susori]	‘pray’
bar [bari]	bibar [bibari]	‘cover’
tun [tunu]	tuntun [tuntunu]	‘forge’

b. Bimoraic Base

LH tone	LHLL tone	
pai	paipai	‘break’
kasa	kasakasa	‘speak’
nantew	nantenantew	‘walk’
feri	feriferi	‘shun’
piri	piripiri	‘defend’
sori	sorisori	‘rise’
daŋ	dannaŋ	‘turn’
pam	pampam	‘drive away’
doŋ	donnoŋ	‘walk affectedly’
sinsan	sinsansinsan	< <i>san</i> ‘return’
pimpam	pimpampimpam	< <i>pam</i> ‘sew’

At first glance, it appears that monomoraic bases generally copy CV, where V is prespecified as [+high] (Marantz 1982), while bimoraic bases copy the entire root. The [+high] prespecification, in Marantz’s conception, overrides the inherent value of [high] in the melodic copy, yielding essentially a high vowel agreeing in rounding with the original. We note also that both monomoraic and bimoraic bases exhibit a similar pattern of retention of a final consonant — it is copied only if it is a nasal.⁵⁶

⁵⁶ Verb roots exceed two morae only very rarely, and then only in loans or ideophones. Lee (1984) reports data about one such root *patiriw* ‘slide’, which copies as *patipatiriw* and *patiripatiriw* in different sources. No inferences can be drawn from this fact.

The Fixed High Vowel in Akan Reduplication

The account given in the text now seems to us incorrect. More promising is an approach along the general lines of fn. 60 (also see Schachter & Fromkin 1968, Hyman 1970, 1972), combined with the same conception of unmarked structure in the reduplicant as in the boxed notes on Tübatulabal (p. 58) and Yoruba (p.63). See M&P 1994b, 1995b and Padgett & Ní Chiosáin 1995.

Whether a base is monomoraic or bimoraic is not determinable solely by its segmental content. CV and CV{?,w} bases are invariably monomoraic, and CV{n,r} bases are monomoraic underlyingly but receive an epenthetic final vowel (described below) at some post-reduplicative stage of the derivation. Roots containing two vowels in underlying representation are necessarily bimoraic. Roots containing a single vowel and ending in *m* or *ŋ* are either monomoraic or bimoraic, with clear minimal pairs with respect to this distinction. The distinction is, however, in no sense opaque, since bimoraic roots invariably have LH tone, while monomoraic ones have H tone only.⁵⁷

Let us first consider the pattern of retention or loss of the final consonant in the copy, an effect that spans the two patterns of reduplication. Other than in word-final position, the only consonants Akan licenses syllable-finally are nasals. This is obviously the explanation for what occurs in reduplication — a nasal consonant is copied because it is the only licit final consonant in a word-internal syllable.⁵⁸

This gives a straightforward interpretation of the bimoraic pattern: there is total root reduplication, subject to the independently motivated syllabic well-formedness condition permitting only nasal codas in word-internal syllables. An additional advantage of total root reduplication is the obvious indifference of reduplication to the canonical pattern of the base: the distribution of consonants and the number of syllables are of no import.

The monomoraic pattern is reducible to total root reduplication as well, given the proviso about licit codas, if we can address the problem of apparent prespecification.

Disregarding the features [tense] and [nasal], which are accounted for by processes entirely independent of reduplication, we have the following vowel system in Akan:

(98) Schematic Akan Vowel System

i	u
e	o
a	

We will consider the feature [back] to be redundant, and will indicate backing distinctions by use of the feature [round]. The copy vowel then agrees in rounding with the original, yielding the corresponding copy vowel system:

(99) Schematic Akan Copy-Vowel System

i	u
i	u
i	

Removal of the feature [back] from lexical representations, prespecification of the reduplicative vowel as [+high], and some assumptions about [+high] overriding [+low] and [-high] will yield the desired pattern of

⁵⁷ Lee (1984) provides a natural interpretation of these tonal facts: the tonal melody is LHL, and the H is linked to the second mora if there is one, else the first mora. Spreading of L derives the surface tonal distribution. Reduplicated forms have tone derived by applying this LHL melody after reduplication.

⁵⁸ Root-internal syllables show there is considerable dialectal variation in the disposition of the copied nasal; it may assimilate or not, and it may delete or not, in some cases depending on whether it is moraic. Details are provided by Schachter and Fromkin (1968:167-177).

alternations. This is essentially the analysis of Marantz (1982). But it obscures important relations between the behavior of reduplication and other rounding harmony phenomena in Akan.

Akan has some quite clear instances of rounding harmony elsewhere. First, in all dialects the vowels of disyllabic verb roots must meet this requirement: If both root vowels are [-high], they must be identical. The sole exception to this regularity reported by Schachter and Fromkin is a root that also is disharmonic with respect to [tense] — a very unusual situation in Akan. The interpretation in terms of feature geometry, along the lines developed by Mester (1986), is the following. The features [low] and [back], which distinguish the nonhigh vowels, are dependent on (that is, further from the skeleton than) the feature [high]. Suppose [high] is expressed lexically only in its negative value; the value [+high] is contributed by a default rule. Thus, the vowels of Akan are reducible to the following:

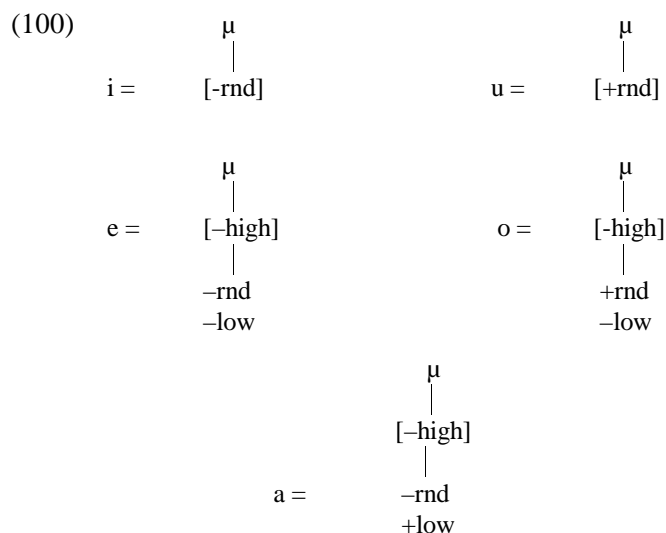

The positions of [high] and [round] are crucial to the root rounding harmony process. If two root vowels agree in the specified value of [high] (that is, [-high]), they must agree in all other features. This follows from abstracting these vowel features out of the consonants, and applying the OCP over the specified value of [high]. The representations in (101) show this. (101a) shows a permissible root with *e* in both syllables; (101b) shows a permissible root with the vowel sequence *i o*; (101c) shows an impermissible root *e o*, blocked by its failure to observe the OCP over [high]:⁵⁹

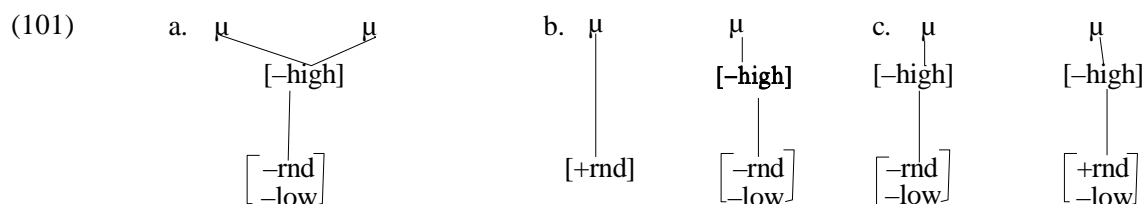

This is not merely a somewhat baroque reformulation of the Akan root rounding harmony constraint. Rather, by positing two fundamental properties of the Akan featural system — unspecified [+high] and the hierarchical relationship between [high] and [round] — it makes strong claims about what other sorts of harmony relationships we should find in this language. These claims are extensively borne out by the harmonic properties of nonreduplicative affixes in the language.

⁵⁹ It is not relevant here, but we could easily make the further move of treating [-rnd] as a default value as well.

We can now use this knowledge to understand what is happening in the reduplicated monomoraic roots. If we suppose that the [high] tier, isolated as in (100), fails to copy, then default introduction of [+high], along with the copied value of [rnd], yields the correct result. The vowel of the Akan reduplicative prefix is a default with respect to height, but does copy the rounding of the base. Thus, in combination with the independently motivated featural tier structure of the language, Akan differs minimally from Yoruba in this respect. The difference in behavior between monomoraic and bimoraic roots within Akan is also minimal: the latter copy everything, the former fail to copy vowel height.⁶⁰

We now turn to another kind of apparent prespecification phenomenon, this one in connection with total reduplication of forms of unbounded size.

Echo words are a class of total word reduplication in which some systematic change is effected in one copy. This phenomenon seems to be nearly universal; the systematic changes known to occur affect peripheral element(s) or vowels. Echo words may have either the pejorative meaning typical of English or a loose kind of plurality ('X and such') characteristic of the languages of the Indian subcontinent:

(102) Echo Words

a. English

table-shmable
book-shmook
fantastic-shmantastic
apple-shmapple
strike-shmike

b. Marathi Type I (Apte 1968)

kholi-bili 'room'
aras-biras 'decoration'
kal-bil 'yesterday'

c. Marathi Type II (Apte 1968)

əwti-bhəwti 'around'
amne-samne 'in front of'

d. Kamrupi (Goswami 1955-6)

ghar-sar 'house'
gharaa-saraa 'horse'
khori-sori 'fuel'

e. Kolami (Emeneau 1955)

pal-gil 'tooth'
kota-gita 'bring it!'
iir-giir 'water'
maasur-giisur 'men'
saa-gii 'go (cont. ger.)'

In the English, Marathi I, and Kamrupi types, the initial consonants, if any, of the suffixed copy are replaced by a specified consonant or cluster. In Marathi II, the prefixed copy simply lacks the initial consonant. In Kolami,

⁶⁰ Another analysis of Akan is possible: copy no vowel features, and allow the quality of the reduplicated vowel to be determined by the independently motivated cross-consonantal harmony rules of the language. The advantage of this approach is that it allows the quality of the intervening consonant to determine the reduplicative vowel just in case the consonant bears some vocalic properties (as it does when labialized or palatalized). This effect is needed in the Akuapem dialect of Akan and also in all other cases of partial prespecification known to us: Nupe, Feʔ-feʔ Bamileke, and Grebo. Like Akan, these other languages impose the partial prespecification phenomenon on a system of total root reduplication.

and in other Dravidian languages as well, the initial CV is replaced by fixed material, *gi* in this case, preserving the underlying vowel length distinction.

Phenomena of this sort are incompatible with templatic prespecification in the style of Marantz (1982) for three reasons. First, the reduplicative template, in this case simply the phonological word *W*, does not indicate the skeletal positions with which the melodic elements are preassociated. Prespecification, under this conception, is at the level of individual skeletal C's and V's. The reduplicative template cannot specify individual C's and V's without being infinitely long (since words are of unbounded length). Second, melodic prespecification is incompatible with a system like Marathi II, since there the grammar must stipulate the absence of a segment in the copy rather than its presence. Third, melodic prespecification is unable to derive the vowel length preservation of Kolami and related languages; since prespecification indicates both melodic and skeletal information, it cannot indicate that the vowel is melodically *i* but preserves the skeleton (i.e., length) of the original.⁶¹

The first of these problems is the one most strongly analogous to the issue that prespecification raises for prosodic morphology. The reduplication in echo words must be characterized by a very high level constituent, *W*, but prespecification is done at the level of individual segments. Similarly, reduplicative skeletons characterized by morae, syllables, or feet at best lead to problems in the interpretation of prespecification. The problem with prespecification is the same; the difference is that echo word reduplication simply cannot be translated into CV or equivalent notation, since it is not bounded.

The rationalization of this conundrum comes from closer consideration of the reduplicative aspect of echo words. Any of the three truly nonlinear models of reduplication described in section 4 provides a configuration of melody-to-skeleton association which is unique for reduplicated melodic elements, either because they are on their own designated melody copy tier or because they involve multiple linking. In any of these models, prior to linearization, we can detect reduplicated melodic elements by inspection of the structure. Echo words differ from reduplicated words in that they have rules sensitive to the reduplicated configuration, detaching melodic elements from the affixal skeleton and replacing them by invariant *shm* or whatever.⁶²

Melodic Overwriting

Melodic overwriting is refined and applied to the Arabic plural vocalism in M&P 1990a. Also see Steriade 1988, Bao 1990, and Yip 1992 for further applications of this idea and Alderete *et al.* 1996 for articulation of this idea within Optimality Theory.

There are three arguments for this approach, apart from the fact that it accounts for an array of facts that find no other place in reduplicative theory. First, it provides a formal mechanism to account for an otherwise unexplained fact about echo words: they cannot appear to be reduplicated. For example, even English speakers with little experience of the phenomenon in (102a) report that words already beginning with the cluster *shm* cannot enter into this pattern: **shmaltz-shmaltz* (with the intended reading). An English speaker with considerable experience of the same phenomenon reports that words of this type systematically have initial *shp* instead: *shmaltz-shpaltz*. Goswami (1955-6) reports a similar fact for Kamrupi: lexical items in initial *s* form echo words with *r*: *saati-taati* 'lamp'. That is, echo formation is necessarily dissimilatory; this sort of context-sensitivity is straightforwardly expressible with rules, but is simply incompatible with blind prespecification. Second, a rule of echo word formation predicts a relatively restricted array of contexts in which melodic elements will be dissociated. We expect the observed pattern of peripheral changes simply because there are only a very few rule contexts — peripheral, all vowels, all consonants — that will be met by all words, as echo word formation requires. Third, having rules sensitive to reduplicative structures applying in echo words predicts other

⁶¹ Vowels are involved in echo words in other ways; witness *Gta?* in McCarthy (1983a).

⁶² This view of echo words is developed in considerable detail in Uhrbach (forthcoming [1987]).

sorts of sensitivity to reduplication. This is in fact the case: Uhrbach (forthcoming [1987]) reports a rule restricted to reduplicated forms that is not reconstructible as prespecification.

Once we countenance this approach to a class of phenomena that cannot be accounted for with prespecification, similar mechanisms are available for the description of reduplication in general. This appears to be necessary to express certain kinds of context sensitivity that are incompatible with prespecification. For example, Yip (1982) reports that a Chinese reduplicative secret language involves a systematic polarity relation between copy and original. Since this polarity relation is not a more general property of the language, it must be specific to reduplicated forms. An even more complex case of context sensitivity of a rule limited to reduplication is evidenced by Grebo (Innes 1966, Beck 1983).

We have seen, then, that the phenomenon of prespecification does not have a single interpretation when we consider more completely worked out analyses and a broader range of data. What consequences does this have for skeletal structure? At a minimum, there are no known cases that are an impediment to our conception of the skeleton, and there should not be any if the rules exhibited by echo words are more generally available. Our approach is compatible with a limited amount of prespecification of the familiar sort: prespecifying a mora will have a reasonable interpretation, and it also makes sense to prespecify an entire syllable or more. Closer study of the relevant cases is obviously indicated.

3.3 Contour Segments

Contour segments are those with linearly-ordered internal structure, like affricates or prenasalized stops (but not segments with multiple points of articulation). At least two theories of contour segments in the literature require a skeleton with segment-sized units, and so we must address them here.

Consider the case of a language that opposes an alveolar affricate *c* to a tautosyllabic cluster *ts*, distinguished by various phonological tests (to be discussed below) and by greater duration of the cluster. Clements and Keyser (1983) propose that this distinction is represented by identical melodies linked to different skeletal configurations:

(103) Linking Theory

a. Affricate *c*

$$\begin{array}{c} C \\ \diagdown \diagup \\ ts \end{array}$$

b. Cluster *ts*

$$\begin{array}{c} CC \\ \diagdown \diagup \\ ts \end{array}$$

The shorter duration of the affricate in comparison with the cluster follows from the ‘timing unit’ interpretation of the CV skeleton: duration rules must figure some count of skeletal elements into their calculations. The affricate (or other contour segment) is recognizable by its multiple linking of melody with skeleton.

Affricates

Research on affricates since 1986 has consistently supported their uni-segmental character, though there are important differences of detail in the representation of affricates in featural terms. See Hualde 1988, Lombardi 1990, Steriade 1993, and Rubach 1994.

Halle and Clements (1983) suggest a different account of contour segments, one which involves biplanar representation. The same contrast is marked by abstracting [continuant] from the melodic representation:

(104) Biplanar Theory

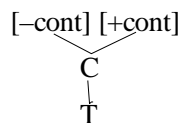
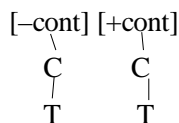
a. Affricate *c*b. Cluster *ts*

The archisegment *T* represents all the features of *c* or *ts* except for [continuant].

The differences between these two approaches are at best subtle and, in any case, are not our concern here. Rather, what we note is that both theories require a skeleton composed of segment-sized units. In both, the contour segment and tautosyllabic cluster are melodically indistinguishable — they differ only in their associations with the skeletal units. With direct association of melodic elements to morae or syllables, this representational contrast simply cannot be made.

There is, however, another coherent view of the affricate/cluster distinction. Let us suppose, in light of results in the investigation of feature geometry by Clements (1985b), Sagey (1986), Mester (1986), Archangeli and Pulleyblank (1986), and McCarthy (1985), that there is a general separation of features into three major types on three associated tiers. A root tier contains the major class features [cons] and [son], a manner tier features like [cont] and [nas], and an articulator tier contains marks major articulator (with dependent finer distinctions, as in the description of Akan vowels in section 3.2). These separate tiers are coplanar, linked in this order with the skeleton. Combined with a prosodic representation of skeleta, this yields the following distinction:

(105)

Tier Theory

a.

b.

Skeletal Tier

Root Tier

Manner Tier

Articulator Tier

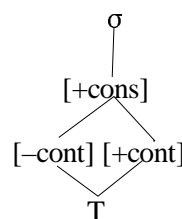
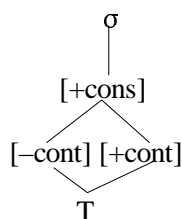

The root tier differs from the CV skeleton in one important respect: it does not indicate quantitative distinctions, and thus in no sense corresponds to segments. Rather, a single unit on the root tier corresponds to the notion ‘single melodic element’.

Empirical differences between this approach and the other two are not hard to come by. Consider first the possibilities for constructing contour segments. The linking theory permits any arbitrary pair of melodic elements to constitute a contour segment, provided the elements match in C/V status. The other two representations require that they agree in some features. In fact, the Tier Theory makes a very strong claim: since the cited literature on feature geometry demonstrates a hierarchical relationship between manner features and articulator features, it predicts that contour segments are possible only if they differ in some manner feature(s) and agree in articulator features. Since we know of no demonstrable cases of contour segments that differ in major articulator, this prediction seems to be correct.

In the case of simple autosegmental spreading, which demonstrably observes no transfer effects (since a melody may freely spread between vowels or consonants of differing length), only the Tier Theory derives the correct results. In Modern Hebrew and in Arabic, the respective affricates *c* and *j* spread intact to multiple positions in the skeleton: *kicec* ‘he cut’ (Bolzky 1980), *hajjaj* ‘he made the pilgrimage to Mecca’. To derive these results it is crucial that affricates constitute a single melodic element that spreads, a notion that is available only in the Tier Theory.

With the cited literature on feature geometry, then, we conclude that there are hierarchical relationships among features of different major types. From this it follows that contour segments have a kind of melodic integrity that the other two theories do not provide, and the behavior and distribution of contour segments confirm this. Only a single question remains: how do we account for the durational differences between tautosyllabic clusters and affricates? In a sense no theory has provided a satisfactory answer to this question. Although a timing unit interpretation of the C/V or X units of a segmental skeleton predicts that clusters should be longer than contour segments, it also makes another, unintended, but even stronger prediction: all languages should have segmental isochrony. This is plainly false, since by using the term ‘timing unit’ it imputes to the segmental skeleton sole responsibility for the durational interpretation of the phonological representation. In fact, an articulated theory of duration that went beyond the contour segment/cluster distinction would necessarily invoke melodic factors as part of the mechanism for determining physical duration.

Consider a remarkably clear case of this sort. All analysts agree that a Mandarin syllable with surface third (MLH) tone is longer than any otherwise identical syllable with a simpler tonal gesture. This is not taken to mean that such syllables have more timing units than others, but rather that the determination of duration respects the need to perform a series of melodic adjustments in these syllables that are not paralleled in others. Since linguistic theory must in any case countenance the idea that the durational interpretation of timing units is modulo the complexity of the associated melodic sequence, we can naturally appeal to the same idea in distinguishing contour segments from clusters. The more complex melodic structure of clusters leads naturally to greater duration under this account, while the true domain of relative isochrony — the mora, syllable, and foot — is left to a skeleton unadorned with segment-sized units.

3.4 Phonological Consequences

It is not our purpose here to provide an exhaustive account of the phonological consequences of prosodic skeleta, and, in any case, many points concerning the phonology of morae have already been explored in Hyman’s important work (1985). Nevertheless, we shall at least offer a brief impression of how phonology comes down on the matter of skeletal make-up.

At the outset, we deploy a general typology of phonological rules for expository purposes. First, there are rules that simply manipulate features in a bald way. Such rules include dissimilations, nonassimilatory changes (like the Sanskrit *ruki* rule), and the like. Second, there are assimilation rules, all arguably reducible to autosegmental spreading. Third, there are rules of insertion or deletion, crucially involving operations of some sort on the skeleton or melodic elements directly associated with it. Fourth, there are rules erecting prosodic structure in, for example, stress systems.

Feature-manipulating rules will in general be indifferent to the constitution of the skeleton. Such rules may exhibit some effects of the internal geometry of the features as described in sections 3.2 and 3.3, but they will not in general refer to the skeleton in any crucial way. This is not surprising — the formal apparatus for this phonological miscellany has remained largely untouched by advances in nonlinear phonology.

Assimilations too are dependent on the internal geometry of the features, but total assimilations alone do involve reference to the skeleton. Since, if we adopt the Uniformity of Linking principle of section 3.1, geminate vowels and consonants can only be represented heteromoraically, it follows that total assimilation will yield a geminate only under these circumstances as well. Where one might expect to see total assimilation of tautomoraic elements, we predict apparent deletion of the assimilated melodic element.

Insertion, deletion, and metathesis rules involve far more direct reference to the skeleton. Consider first the case of vowel epenthesis. Broselow (1982) presents a valuable typology of epenthesis rules which is useful to our discussion. First, there are epenthesis rules required by constraints on words (rather than syllables). These constraints are in fact reducible to minimal word requirements of the sort that are by now familiar; we discuss several such cases in section 1, and they are all obviously compatible with our view of the skeleton. Second, there are epenthesis rules that respect melodic sequencing constraints. Dorsey’s law in Winnebago is a rule of this type,

enforcing a prohibition on obstruent-sonorant sequences without regard for their syllabification. Such rules are, by any account, indifferent to skeletal architecture. Third, the largest class of vowel insertion rules is represented by epenthesis solely to allow syllables to be constructed out of otherwise unsyllabifiable (that is, stray) elements.

The close study of the last type of epenthesis has been a major area of research in skeletal theory, as the insightful contributions by Levin (1985) and Itô (1986) demonstrate. But a segmental skeletal theory works under an insuperable impediment in such matters: it predicts the existence of a fourth type of epenthesis, skeletally conditioned epenthesis that does not deal with stray elements. This follows from the nature of the segmental skeleton — epenthesis involves insertion of a V or nuclear X slot, and it is difficult to restrict this in the intended way. To achieve the desired result, we would somehow have to prohibit rules that insert the most primitive element of skeletal representation. In a prosodic theory, on the other hand, the result falls out essentially from the nature of the representational system: there are no V or X slots to insert.

A comparable typology and comparable results hold for consonant epenthesis. The syllabic conditioning of consonant insertion involves, in all cases known to us, observance of the general requirement that syllables have onsets, as in the case of insertion of *ʔ* before initial vowels in Arabic. Here, too, we rely on the absence of C slots to account for the absence of rules of consonant insertion not motivated in one of the three ways described above.

Deletion phenomena also crucially bear on skeletal representation. Since Prince's (1975) and Ingria's (1980) demonstration that compensatory lengthening follows from melodic deletion plus reassociation to the vacated skeletal slot, it has been known that this phenomenon is a strong source of evidence for skeletal theory. What has never been satisfactorily explained is why deletion of the initial consonant in a CV syllable does not yield compensatory lengthening of the following vowel, or why deletion of the first consonant in a tautosyllabic VCC sequence does not produce lengthening of either the adjacent vowel or consonant (if the two consonants are also tautomoraic). The explanation for this is straightforward in a purely prosodic theory of the skeleton: compensatory lengthening, like the formally similar process of total assimilation, is possible only between heteromoraic elements.

Compensatory Lengthening in Moraic Theory

The argument made here was later developed at length by Hayes 1989.

The last class of phonological phenomena to which we turn are the rules erecting prosodic structure. Although stress theory has gained considerable ground with a conception of nucleus, rhyme, and syllable projections, it has never explained why this entire class of rules must always operate on projections at all, instead of the segmental skeleton, the most basic level of prosodic structure. The same question, of course, can be asked about tone. The problem is rendered more urgent by the disappearance of the notion 'projection' from the domain that originally motivated it, harmony, where it has been essentially supplanted by an articulated feature geometry. One could, perhaps, shift the burden of this conundrum to some theory of phonological substance — 'it only makes sense to stress syllables' — but this is unsatisfactory. Phonological substance may constrain the grammars generated by an overly free formal theory, but it never induces the formal theory to assert a mechanism like projection. Moreover, one could imagine quite sensible test cases that respect the substantive theory: build binary feet on the skeleton directly, interpreting this as stress on any syllable containing a segment in strong position. In any language containing some (C)V syllables, this makes straightforward predictions about the pattern of accentuation. The absence of such cases constitutes a serious liability of the segmental skeleton.

The prosodic skeleton responds to this objection in the best way possible: all levels of prosody are available for the construction of superordinate levels of prosody. Projections have no role in such a system; the sensitivity of stress only to moraic, syllabic, or higher structure follows from the nature of the prosodic hierarchy.

4. The Nature of the Mapping Relation

Until now, we have largely eschewed discussion of reduplicative association for two reasons. One is purely expository: we wished to focus on the independent question of the form of the skeleton. The other is principled: the effects of choice of skeleton are not limited to reduplication, with its peculiar demands on association, but instead extend to purely templatic morphology, to phonology, and to the theory of counting as well. It is now appropriate for us to turn to this question.

The independence of choice of skeleton from the mechanism of reduplicative association is not perfect. We will therefore briefly examine several different views of the association mechanism, evaluating their consequences for our theory.

4.1 Melody Copying on the Same Tier

Up to this point in the discussion we have adhered rather closely to the claims of Marantz (1982) about the mechanism of association in reduplication. Let us review the tenets of that analysis:

(106) Reduplicative Association Principles (after Marantz 1982)

- a. The phonemic melody of the base is copied ‘over’ the empty skeleton of the reduplicative affix on the same tier as the original phonemic melody.
- b. The association of the phonemic melody with the affix is one-to-one, left-to-right in the case of prefixes, right-to-left in the case of suffixes. Marked exceptions to the directionality of association are permitted.
- c. Association is phoneme-driven in the sense that elements are taken from the phonemic melody in the stipulated direction, the skeleton is scanned for compatible, accessible slots in the same direction, and association is accomplished if possible. [If a phonemic melody element finds no accessible, compatible skeletal slots, go on to the next phonemic melody element.]
- d. Erase unassociated elements of the phonemic melody and of the skeleton.

The notions of compatibility and accessibility are independently characterized in such a theory; a slot and melodic element are compatible if they meet any requirements imposed by the C/V distinction or, equivalently, by prosodic structure. A slot is accessible to a phonemic melody element if it can be reached without crossing association lines. The addition to (106c) is not explicitly made by Marantz, but is clearly a necessary concomitant of the analysis, since it is the sole means by which phonemic melody elements may be skipped in the course of association.

We noted already in section 1 that this skipping of phonemic melody elements is in fact (but in no theory) rigidly constrained. Association is normally continuous; it terminates when it encounters an unassociable melody element. For example, in Ilokano progressive formation (v. (7)) the σ prefix applied to *da.it*, in which the vowel sequence is necessarily heterosyllabic, does not go on to link the *t* when it fails to link the *i*: **dat-da.it*, *da-da.it*. Likewise, foot suffixation in Manam reduplication (section 2.2) does not pass over vowels in search of an initial consonant once it has its two morae: *mo.ita* → *mo.ita-ita*, **mo.ita-mita*. A final case: earlier (section 2.2), we raised the question of why there is no monomoraic suffixing reduplication, yielding, for example, *badagDA*. With phoneme-driving, this is impossible. Even without phoneme-driving, it involves an impossible pattern of skipping a melodic element.

The skipping phenomenon is limited to σ_c , as in Sanskrit *du-druv*; we have no suggestion except to stipulate it.⁶³ We take cold comfort in the fact that there is no known theory that does any better.

⁶³ Other apparent cases of skipping are all associated with the phenomenon of prespecification, and are therefore irrelevant to this issue. See section 3.2.

A related issue involves the notion of phoneme-driven association. In a theory with segmental skeleta and without the Satisfaction Condition, phoneme-driven association is essential. In this view, the Diyari affix of 2.1 is CVCCV, and skeleton-driven association would yield such absurd results as **NAPRI-napiri*. (Even worse things happen if bases can be vowel-initial.) But this is simply an artifact of the hyperspecified skeleta required in such theories; a true prosodic characterization of the skeleton ($\sigma\sigma$ in this case) encounters no such difficulties. Parsing the copied phonemic melody by the affixal skeleton — essentially skeleton-driven association — yields exactly the desired result. Eliminating phoneme-driving also eliminates one of the most apparent differences in the mode of association employed by reduplicative versus templatic systems.

The stipulated dependence of direction of association on whether the affix is prefixed or suffixed is clearly unprecedented in any domain outside reduplication. We take it to be related to prosodic structure; reduplication is always from an edge inward. (Comparably, prior to any affixation, prosodization also starts at an edge, but a stipulated one. See Itô (1986) for discussion of the directionality of syllabification parameter.)

Edge-in Association & Alignment

There is a strong connection between the “edge-in” character of reduplicative association and the special status of constraints aligning the edges of morphological and prosodic constituents. See M&P 1993a, 1994b. Also see Yip 1988 for further discussion of edge-in association.

In this way we relate direction of association to more general considerations of the assignment of prosodic structure. The claimed virtue of a the purely stipulative direction of (106b) is that it represents merely an unmarked alternative; that is, some patterns of reduplication systematically deviate from the normal order of left-to-right in prefixes and right-to-left in suffixes. The known examples of this sort are either misanalyzed or too sparsely described for inferences to be drawn. First, Chukchee reduplications of the *nutenut* type are claimed to display left-to-right association with a CVC suffix. This is false: the language independently deletes stem-final vowels that are also word-final (Kenstowicz (1979), Kim (1984)), and the purported base of this reduplication *nute* is not a free form but rather an underlying representation. Second, the Madurese (Stevens 1968) pattern in which a copy of the stem-final syllable is prefixed (as in *waʔ-buwaʔ-an* ‘fruits’), is straightforwardly derived by total stem reduplication, yielding /buwaʔ-buwaʔ-an/, and a subsequent rule reducing the left branch of a compound to its stressed (that is, final) syllable (see section 2.4 for further discussion). Both of these rules, stem reduplication and compound truncation, are extensively independently motivated in the language.⁶⁴ Tzeltal, described by Berlin (1963), is a case of total root reduplication in which material other than the initial consonant is fixed (prespecified); it has no bearing on directionality of association. The final case, from the Northwest Coast language Tillamook (Reichard 1959), is so poorly described and inconsistent that a number of plausible alternatives (like cluster simplification) simply cannot be tested. In sum, with these examples out of the way, there is an inviolate requirement of contiguity or locality between the original string and its copy (Kim 1984). In our conception, locality emerges as a theorem of edge-in reduplication.

These three moves — a rigid restriction on skipping, elimination of phoneme-driven association, and edge-in reduplication — are not strictly relevant to the overall structural possibilities of reduplication. We turn now to examining alternatives to (106a).

⁶⁴ According to Stevens’s (1968) characterization of reduplication and truncation, the two rules display different junctures. No data in support of this juncture distinction are provided, but were they to exist they would merely show that the truncation rule is applicable at more than one lexical level. See Weeda (1986 [1987]) for a different view.

Base/Reduplicant Identity

Our recent work on this subject sees identity in terms of constraints on a relation of correspondence between the base and the reduplicant (M&P 1993a, 1994ab, 1995b), which are formally parallel to the faithfulness constraints between input and output. Reduplicative over- and underapplication (Wilbur 1974, Marantz 1982, Carrier-Duncan 1984, Kiparsky 1986, Mester 1986) can then be understood in terms of the interaction of such Base-Reduplicant identity constraints with other phonological constraints. On this, see M&P 1995b; Benua 1995, forthcoming, Burzio 1996, Cohn & McCarthy 1994, Flemming & Kenstowicz 1995, Kenstowicz 1995, Itô, Kitagawa, & Mester 1996, Orgun 1995, McCarthy 1996, Pater 1995, Urbanczyk 1995, 1996ab, Yip 1995ab.

4.2 Melody Copying on a Different Tier

In Broselow and McCarthy (1983-4), it is proposed that the reduplicative melody is copied on a different tier from the original. Two advantages were claimed for this approach: it conforms more closely to the one morpheme-one tier rubric of McCarthy (1981, 1986), and it is necessary for the description of certain kinds of infixing reduplication (to be described below).

Levergood (1983) notes an incorrect consequence of this approach to melody copying in the overall context of Broselow and McCarthy's theory. In that theory, the Washo pattern of section 2.3 is analyzed as VCV inserted after the initial C, with stipulated right-to-left association (cf. *ʔewši* → *ʔeši.ewši*). What prevents there from being a language in which the copy appears inside the string it copies? This will occur any time the infix is large enough to associate with some of the material relative to which it was inserted, since the entire melody is available, in copy form, on another tier.

Our approach simply does not have that consequence for cases like Washo, even if the melody is copied on a separate tier. Since we have, in effect, eliminated infixing reduplication in such languages by use of extraprosodicity, the nonoccurring situation is in fact impossible.

Having eliminated the one liability of a separate tier for the melodic copy, we can now explore its advantages relative to copying on the same tier. There are two, one quite general and the other more specific.

We demonstrated in section 1 that unassociated skeletal elements constitute a serious problem for reduplication, since phonological theory provides ample mechanisms by which such elements might exert various influences on the derivation. Thus, the erasure of unassociated skeletal positions in reduplicative affixes must be stipulated to occur instantaneously, rather than in conjunction with some wholesale stray erasure later in the phonology. We adduced a theory, involving the Satisfaction Condition, which meets this objection by allowing no unassociated skeletal elements. The same objection, though, can be raised for copied but unassociated melodic elements. Such floating melody units are not unknown either in the tonal or nontonal literature. They may be expected to condition melody-level phonological processes; in particular, they could condition the application of purely melodic assimilation rules on the tier-adjacent melody elements of the base. In fact, no copied phonemic melody elements ever display such behavior;⁶⁵ they are entirely silent in the phonological derivation, and so they too must be erased immediately as part of the reduplicative procedure. Cases where this is particularly important include Orokaiva in 2.1 and Murut in 2.3; in neither case is the homorganic nasal-stop structure created across the two melodies.

Copying the melody on a different tier from the original largely meets this objection without requiring a special melodic erasure principle. Consider the representation of hypothetical *bad-badupi*:

⁶⁵ But see the discussion of Lardil in footnote 2.1.4.

(107)

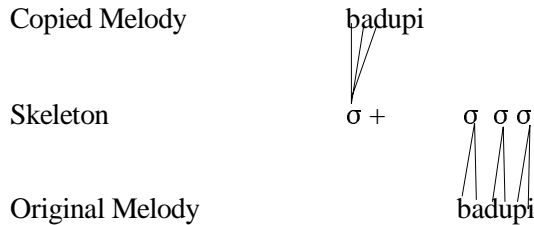

The offending melody elements are the unassociated parts of the copied melody *upi*. These elements will be invisible to rules referring to both skeleton and melody under either conception of the tier structure, but a difference emerges in rules that apply on the melody level only. Suppose the language has a rule palatalizing *b* after *i*, a rule that is purely melodic. If original and copy are on the same tier, and if no special provision for erasure is invoked, then this rule may be expected to apply to the second *b* in *bad-badupi*, since melodic contiguity is all that matters. If original and copy are on different tiers, however, the same rule is inapplicable; no adjacency relation holds between the two melodic elements involved in the rule.

Since this sort of super-overapplication is unprecedented in analyses of reduplication, we take this to be a desirable consequence of copying the melody on a separate tier. Two other questions arise. First, are there melody-only interactions between the associated and unassociated elements within the copied melody?⁶⁶ The answer is yes; that type of overapplication is instantiated in Luiseño, as interpreted by McCarthy (1979) and Mester (1986).⁶⁷ What about melody-only interactions between the original and copied melody? These come under the rubric of Tier Conflation in McCarthy (1986) (or some equivalent mechanism for interpreting structures); when the tiers are conflated, the two melodies are linearized on a single tier and unassociated elements necessarily drop out in an independently motivated way.

Thus, we have briefly shown that melody copying on a separate autosegmental tier provides an accurate account of intramelodic interactions without appeal to immediate erasure. It also accounts for a system of infixing reduplication that is peculiar to templatic morphology. Templatic systems, with their total separation of melody and skeleton, exhibit a type of infixation that is not found elsewhere. In Arabic, for example, there are infixes with melodic but without skeletal content, whose position in the skeleton is determined not by infixation or extraprosodicity, but by rules of association. Templatic systems have a comparable freedom to use reduplication in a relatively unpredictable way; Arabic contrasts lexical items *falfal* and *sammam*, built on identical independently needed skeleta from biconsonantal roots, but with reduplication in the first case and spreading in the second. It is impossible to predict which option will be taken, and often both are in related words. Reduplication is not simple affixation in root-and-pattern systems (*fal* is an impossible stem), any more than root-and-pattern morphology itself is simple affixation.

Templatic systems can compose their special brand of reduplication and infixation to yield a type of infixing reduplication that is quite different from that described in section 2.3. In some modern dialects of Arabic, a widely used pejorative verb form is *barbad*, from the root $\sqrt{\text{brd}}$, in which a copy of the first root consonant appears at the beginning of the second syllable. The $[\sigma_{\mu\mu} \sigma_{\mu\mu}]$ template occurs independently (see section 2.4); it is not derived by a rule of infixation. Rather, the root melody is copied on a separate tier and associated in the direction universally used in Arabic, LR, to yield the following representation (somewhat simplified):

⁶⁶ A different conception of the role of a copy tier in overapplication is pursued in Cowper and Rice (1985).

⁶⁷ Marantz's (1982) analysis of Luiseño relies on claiming that the relevant rule (a *č/š* alternation) is cyclic. The rule is, however, non-structure-preserving (that is, nonneutralizing) and surface true, incompatible with cyclicity. Two arguments for its cyclicity are presented. One involves a demonstration that the rule is neutralizing; the sole example is an interjection. The second involves showing that the rule treats certain external (Level II) affixes like word boundaries. In light of Borowsky's (1986) demonstration that Level II phonology and postlexical phonology are coextensive, this argument is without force.

(108)

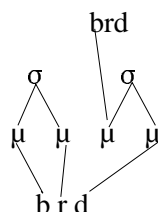

The comparable case in Temiar (*sglog* < $\sqrt{\text{slog}}$) is derived in the same way. As Broselow and McCarthy (1983–4: 42) note, the difference in direction of association in Arabic and Temiar infixing reduplication (LR and RL, respectively) can be derived from the overall direction of mapping and spreading observed elsewhere in the two languages.⁶⁸ The reduplicative aspect of the Arabic example is paralleled by *falfal*; the infixation is paralleled by *ktanbab* (< $\sqrt{\text{ktb}}$). Templatic infixing reduplication emerges as a natural consequence of the independently needed properties of purely templatic systems if we have melody copying on a separate tier.

4.3 Synchronous Skeleta

Two classes of empirical problems with melody copying approaches have been addressed in the literature. The first involves the phenomena of phonological rule over- and underapplication in reduplicated forms. Overapplication occurs most commonly when an external affix triggers some transformation in both copies of the base: Indonesian /*məN+pikir-pikir*/ → *məmikirmikir*. Underapplication is most common when a rule that would occur in one copy under the influence of the other copy is blocked. Obviously we cannot deal adequately with this rich field here, but there is a literature (Mester 1986; Uhrbach 1985, forthcoming [1987]; Cowper and Rice 1985; Carrier-Duncan 1984; Odden and Odden 1985) arguing for a treatment of over- and underapplication different from that in Marantz (1982).

A different problem, noted in the first instance by Levin (1983), occurs in Mokilese. Recall from our earlier discussion that Mokilese heavy syllable reduplication copies long vowels as long. We meet with the same effect in Lardil foot reduplication. This effect, which Clements (1985a) has dubbed *transfer*, is instantiated at levels of prosodic constituency higher than the syllable as well. One aspect of the general problem is that long vowels are required to copy as long, providing there is sufficient room in the skeleton for them, and similarly for long consonants. The theory as outlined in (106) makes no allowance for the preservation of length distinctions. A more dramatic case of such transfer is provided by total reduplication of stems or words, in which every prosodic characteristic of the original is precisely replicated.

Overapplication, Transfer

On overapplication and other paradoxical phonology/reduplication interactions, see above p. 75.

On transfer, see M&P 1988, 1993a: Chapt. 5 and Steriade 1988.

Two recent proposals for a reorganization of the relation between copy and original in reduplicative structures have emerged which address these issues. Clements's (1985a) view, which we will call the *Parafix Theory*, holds that the skeleta of base and affix are simultaneous and linked to one another, and that the effect of phonemic melody copying is achieved by transferring onto the affixal skeleton the associations of linked base skeletal elements with the phonemic melody (109a). The *Unimelodic Theory* in Mester's (1986), McCarthy (1985), and Kitagawa (1985 [1987]), on the other hand, holds that linking is between the affixal skeleton and

⁶⁸ Zuni (Broselow and McCarthy 1983–4) is also a case of this sort. The system is clearly templatic; only CVCV verbs, whose vowels are identical in all known examples, display the alternation.

the phonemic melody directly (109b). Consider the intermediate representations generated by these two theories for the Agta form *barbari*:

(109)

a. Parafix Theory



b. Unimelodic Theory



These approaches have several virtues. First, both eschew copying of the entire phonemic melody, and thus bypass the objection that copied but unassociated phonemic melody elements are phonologically impotent. The Parafix Theory, moreover, provides a direct account of the transfer phenomenon; since the phonemic melody elements are copied with their associations from the base, transfer is a necessary consequence of such an approach. And the Unimelodic Theory, although it cannot account for transfer in any nonstipulative way, does open the way for a new means of accounting for reduplication/phonology interactions. Since a single melodic element is associated to more than one skeletal position, overapplication can be interpreted as a rule applying to the melodic tier alone, necessarily having effects on more than one ‘copy’ at a time. Underapplication can arise from two sources — rules whose structural descripton is not met before linearization of the synchronous skeleta, and geminate unanalyzeability effects. After linearization, rule application is normal.

Clements (1985a) explores a comparable approach to over- and underapplication in the Parafix Theory, but this theory predicts a wider variety of rule/structure interactions than the Unimelodic Theory. Before transfer of the melody to the affixal skeleton, we get both overapplication and underapplication. After transfer, but before linearization, we get underapplication but no overapplication (which relies on the single melody). After linearization, finally, all rule application is normal. The Parafix Theory, then, has three stages of representation to the Unimelodic Theory’s two. The need for the middle stage of the three has never been demonstrated, although it should be noted that the critical ordering arguments are typically of great subtlety.

Obviously no property of either theory is incompatible with the exclusively prosodic conception of the skeleton that we develop — in fact, both Clements and Mester use prosodic skeleta in some cases. But certain differences between melody copying and these theories do emerge in light of our results.

These approaches share the characteristic that reduplication involves a skeletal affix which is synchronous with the base. Although morphology which is synchronous in some sense is not unknown (witness Semitic), skeletal synchronicity is unique to reduplication. In effect, then, the claim that reduplication is affixation is discarded by these approaches. Both theories are at a serious disadvantage in comparison with the melody copying theories in another respect. On the one hand, the two theories must stipulate some direction of association of each affix with the base. On the other hand, though, they must somehow retrieve this information when it comes time to linearize the representations in (109). If direction of association and direction of linearization are entirely divorced from one another, then the requirement of locality or contiguity between the original and the copied strings becomes unattainable. This problem is by no means a trivial one; if association and linearization are separated by the application of other rules, as Clements and Mester carefully argue to account for over and under-application, then some global mechanism (like features [Prefix] and [Suffix]) will be needed to transmit information through the course of the derivation. Furthermore, this linearization operation, whatever its character, will be another mechanism peculiar to reduplication, since any efforts to collapse it with the independently motivated mechanism of Tier Conflation (McCarthy 1986) run afoul of precisely this linear order problem.

There are also specific empirical problems with the synchronous skeleta approaches in their relation to the Onset Rule. Recall from our discussion of all three types of reduplication (suffixing, infixing, and especially prefixing) that applications of the Onset Rule across the affix-base juncture are critical to accounting for patterns of reduplication. This is especially true of the apparent XX or XXX variety: *wa-waeke*, *uh-uhuke*. At the

appropriate points we noted a large number of typological results that follow from this approach; in particular, we saw that XX or XXX is an illusion based on onset creation, and therefore breaks down precisely on C-initial/V-initial lines. This explanation and the other results of the Onset Rule are simply unavailable if the skeleta are synchronous; we could never associate *h* to the onset of the base skeleton.

How then do we capture the not insignificant virtues of the synchronous skeleta theories without incurring this liability? We have already spoken briefly to the issue of overapplication; if the melody is copied on a different tier but immediate erasure of unassociated elements is not invoked, some effects of overapplication are available and others may be obtainable as well. Underapplication is also possible in these terms; melody-only rules will fail to apply to the melodies on distinct tiers until they have been linearized. The overall pattern of overapplication and underapplication needs reevaluation, however, in the context of Lexical Phonology (Kiparsky 1982), in which phonological/morphological interactions of this sort are not a peculiar feature of reduplication but instead are the norm for all aspects of the morphology.

As for transfer, we defer first to Marantz (1982: 455): ‘We must assume that the Cs and Vs of the stem in syllabic reduplication are copied clustered in the syllabic units that they form in the stem.’ Referring here to a pattern he analyzes as disyllabic reduplication in Yidiŋ (foot/minimal word in our terms), he thereby explains the transfer of syllable structure from original to copy.⁶⁹ In our approach, there are no C’s or V’s, and the notion of clustering is not independently defined, but we have an alternative interpretation in the same spirit. Rather than copy the phonemic melody, we copy all the prosodic structure subordinate to the category stipulated by the reduplicative affix. That is, the prosodic hierarchy defines the properties of transfer.

The explanation for perfect transfer in total reduplication is trivial in these terms; every aspect of prosodic structure below *W* is copied along with the melody. If the reduplicative affix is F, we copy all syllabic and moraic structure along with the skeleton. This accounts for vowel length transfer in Lardil. If the reduplicative affix is σ , as it is in Mokilese (since bimoraicity is predictable from membership in the ‘loosely-bound’ affix class of the language), then we copy moraic structure only. Mokilese transfer is thereby accounted for.

This copied prosody does not survive unaltered. In Mokilese *čaačaaak*, the final *k* cannot remain linked in the copy, since CVVC syllables are not licensed word-internally. In Lardil and in all other languages, the edge between linked and unlinked elements is subject to maximization of association: *pareli* reduplicates as *parelpareli*. In effect, what transfer preserves, subject to the requirements laid down by the reduplicative affix, is the moraic structure of the original, and nothing else.

4.4 Line Crossing

All theories of the mapping operation entertained so far involve a stipulated difference between reduplication and spreading. In reduplication but not in spreading, either the melody is copied or the skeleta are synchronous rather than linearly ordered. Here we briefly explore a novel conception of reduplication, one in which spreading and reduplication are instances of the same phonological principles. It does require that we give up the only hitherto inviolate constraint of autosegmental phonology, but it replaces it by something nearly as good. Our remarks are naturally speculative at this point, but the consequences we point to are worth considering.

⁶⁹ In fact, we regard Yidiŋ as prefixation of a minimal word to a minimal word, not as transfer. The contrast between Yidiŋ and Lardil in the treatment of CVCVCV bases is otherwise inexplicable. See section 2.1 for discussion of these two languages.

Our proposal is embodied by the representation of *barbari* in (110), and we shall develop the underlying principles immediately below:

(110)

Crossing Theory



It is obvious that this tree contravenes the prohibition on crossing association lines, the only principle of the theory which has survived unscathed since Goldsmith (1976). The affix σ is linearly ordered on the same tier with the base skeleton $\sigma\sigma$, yet the phonemic melody has not been copied. Rather, the phonemic melody elements *bar* exhibit dual linkings, one each with base and affix.

Line-Crossing Theory

See Bagemihl 1989a for an interesting development of line-crossing theory, as well as Itô *et al.* 1996. For our current view of reduplicant/base identity, see the references cited on p. 75.

Rather than immediately describe the principles underlying such a representation and the motivation for it, we shall reflect for a moment on the line-crossing prohibition. There is a certain redundancy in representations which observe the prohibition on line-crossing, first noted implicitly by Halle and Vergnaud (1980), who suggest that lines be replaced by indices. This redundancy idea is developed in Sagey (1986), who argues as follows. Consider the autosegmental representation (111):

(111)



In (111), linear order relations are fully defined among $\{A, B, C\}$ and among $\{d, e, f\}$, since the members of each set are on the same tier. We define the association relation as one of **simultaneity** (in her terms, overlap in time). Association therefore links elements occurring at the same time. Under this definition, adding a link from *d* to *C* would necessarily lead to a contradiction (since *d* cannot be simultaneous with *A* and *C* and not with intervening *B*).

Her conclusion is that the line-crossing prohibition is not a primitive of the theory, but rather follows from these two premises: linear order relations are fully defined within a tier, and association expresses simultaneity.

Melody-copying approaches to reduplication respect this view of the world; they have ordering within tiers and association as simultaneity. The theories with synchronous skeleta do not; although they preserve ordering within tiers, association cannot be construed as simultaneity, since two skeleta cannot occur at the same time. (The linearization of skeleta at some later stage of the derivation reflects this interpretation; the interface with the real world of phonetics does respect simultaneity.)

In a sense, then, synchronous skeleta give up the line-crossing prohibition since they give up one of the premises from which it is derived. The alternative we explore here gives it up in another way: by denying the strict ordering of elements within a melodic tier. The redundancy in the theory is eliminated either way.

There is another class of arguments, empirical this time, that suggest that an absolute prohibition on line-crossing is too strong. Dorsey's law in Winnebago (Miner 1979, Hale and White Eagle 1980) is a typical example of the phenomenon of vowel-copying epenthesis. Dorsey's law accounts for the following partial derivations:

(112) Winnebago		
Underlying		Derived
hoikwe		hoikewe
krepna		kerepana
pras		paras
rupri		rupiri
xwu		xuwuxuwu

This rule is impeccably justified by alternations, by the behavior of reduplication, by interactions with phonological rules, and by the distribution of stress. The generalization is that a [-son][+son]V sequence, medial or initial, is broken up by insertion of a copy of the vowel between the obstruent and sonorant. The problem we are attending to is obviously the phenomenon of vowel copy. There are four possible approaches. First, we might suggest that vowels and consonants are represented on separate planes. If this is so, then Winnebago is surely the frailest reed on which this far-reaching claim has yet leaned, since no other facts of the language point that way. Second, we could appeal to the notion that consonantal and vocalic articulators are disjoint (as in 3.2), but this immediately runs into the fact that the glide *w* is transparent to the copying process (as it happens, no examples with *y* in the requisite environment are attested). Third, we could adopt a phonological copying operation, which unfortunately would have none of the character of the reduplicative one (since the former is strictly local) and which would produce a massive increase in the power of phonological theory. The fourth alternative, and the one we shall support, is that cases of this sort are instances in which association lines do in fact cross.

Dorsey's Law

On Dorsey's Law and similar phenomena, see Steriade 1990 and Gafos 1996.

Let us now turn to the details of the theory and rejoin Winnebago at a later point. Our proposal is embodied in the following principles:

(113) Principles of Association

- a. Crossing Avoidance. Do not cross association lines which have not yet been crossed.
- b. Maximization of Association. Associate as many different phonemic melody elements as possible.
- c. Priority Clause. In case of conflict between (a) and (b), (b) has priority.

The essential character of this proposal is that the prohibition on crossing association lines is relativized under clause (c); that is, it is subordinated to association of phonemic melody elements under certain conditions. Overriding all aspects of these principles are certain absolute requirements: the demand by the Satisfaction Condition that all skeletal positions be exhausted and whatever language-particular licensing conditions there are on the melody-to-skeleton association.

Let us now consider the consequences of this proposal. For cases like (110), the association principles as stated give just exactly the nested pattern of crossing dependencies that is required. The unadorned representation, before any lines are drawn to the reduplicative affix, first undergoes association of *b* to the initial position of the affix — no lines are crossed, so both (a) and (b) are fulfilled in their perfection. Subsequent associations exhibit the priority of (b) over (a) — one line is newly crossed for each new melodic element associated.

It is apparent that the relative contiguity of the original and its copy follows from the minimization of crossing association lines demanded by (a). This means that (a) alone is responsible for the universal direction of association in reduplication: left-to-right with prefixes, right-to-left with suffixes. In a sense, clause (a) is

independently motivated by virtually all autosegmental analyses: analyses in which lines are never cross minimally entail a theory in which line-crossing is avoided.

Clause (b) of the association principles is also independently motivated. It is implicit in any principles of association like phoneme-driving, and it serves other functions as well. The hundreds of Arabic quadrilateral roots are almost never applied to a skeleton in which there are insufficient free skeletal slots for all root consonants to be associated. Rules that would disturb the complete association of the root are also blocked — for example, the reassociation rule in McCarthy (1981) responsible for medial gemination in *kattab* is suppressed with quadrilateral verbs like *tarjam* because of a principle essentially identical to clause (b).

Like both the Parafix and Unimelodic theories, this has the advantage of not requiring phonemic melody copying. It has the advantage over these two theories with respect to applications of the Onset Rule; it encounters no difficulty in handling cases like Orokaiva and the like. It also allows an account of over- and underapplication similar to that of these two theories.⁷⁰

The representations with multiply-linked melodic-elements are submitted to a block of (lexical) phonological rules, and rule application is governed by familiar constraints independently needed for the treatment of geminates. At some later point — arguably at the end of each level or the end of the lexicon — Tier Conflation applies, linearizing the representation by performing the actual melody copying operation. This corresponds closely to the conception of Tier Conflation in McCarthy (1986): TC produces representations in which the linear order of melodic elements is identical to the linear order of the associated skeletal elements. Unlike in the synchronous skeletal theories, we can actually appeal to Tier Conflation, because the representations we posit for reduplication contain all information about linear order, just as those in root-and-pattern systems do.

We have seen, then, that a set of principles of association which relativize the prohibition on line crossing considerably reduce the amount of reduplication-specific machinery required by the theory. Can we eliminate such machinery entirely? Perhaps not, but at the very least we can demonstrate that many of the same mechanisms are needed independently to account for longstanding problems outside the realm of reduplication.

Recall the generalization embodied in Dorsey's law in Winnebago, which is representative of a whole class of vowel-copying epenthesis rules. We showed that separation of consonantal and vocalic articulators will not account for this phenomenon, since even a high glide (melodically indistinguishable from a vowel) may intervene between original and copy. We dismissed as absurd the suggestion that vowels and consonants are represented on separate, morphologically-characterizeable planes in this language. Our conclusion, then, is that either phonological theory recognizes a primitive operation of melodic copying, or that it licenses line crossing in general, as in the derived representation of ...*kewe*:

(114)

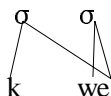

Contemplation of such phenomena, in fact, yields a laudably restricted theory of apparent phonological copying. The copy is always determined locally with respect to the set of vowels — that is, gratuitous crossing of association lines is avoided in conformity with clause (a) of the principles. The process is nevertheless rule governed — we must stipulate the direction from which the vowel comes in Winnebago, and in cases like Palestinian Arabic (Kenstowicz 1981) we must restrict spreading to stem-internal contexts, since otherwise a default vowel emerges. The general case of languages without copying epenthesis also demands a rule-based account. But the fact that such a rule exhibits the sort of locality predicted under our approach confirms both the need to permit line crossing and the need to restrict it as we have done.

⁷⁰ For transfer, it can, like the melody-copying theories, rely on linking of higher-level prosodic elements.

Having demonstrated that there is great utility in permitting lines to cross under certain circumstances, we must also show that no results of the absolute prohibition are unavailable to us. For example, it has been suggested (McCarthy 1979, 1981; Marantz 1982) that the line-crossing prohibition accounts for the nonexistence of mirror-image reduplication rules — those that copy and reflect a string. In fact, Marantz's approach has redundant explanations for this effect — it follows not only from the prohibition but also from the nature of the association procedure. It is ruled out by clause (a) in our case, since it would inevitably involve gratuitous line crossing. Clause (a) also accounts for the fact that lots of phonology can be done without ever finding instances of lines crossing. The override of (a) by (b) under clause (c) is met with chiefly in reduplicative systems because they alone have substantial skeletal regions bearing prior associations and substantial skeletal regions without prior associations.

The remaining case in which an absolute prohibition has been claimed to have utility is the phenomenon of geminate integrity, first examined in this connection by Steriade (1982). The fact that geminate consonants resist internal epenthesis is taken in Steriade's work and subsequently to be a direct consequence of the inability to associate a vocalic melody with a skeletal slot 'inside' a geminate without line crossing. As Levin (1985: 87) is careful to point out, however, if epenthetic vowels are in fact default vowels, so that they are represented through much of the derivation without associated melodic material, it follows that this sort of explanation is simply no longer available. Even if we would later discover that the representation could not undergo the default rule, intervening rules would have treated the epenthetic vowel as if it were there. Rather, it is likely that an appropriate condition on the analyzability of geminates by phonological rules will derive this result instead.

Since the failure of epenthesis into geminates is the sole result of an absolute line-crossing prohibition in phonological theory (other results following equally well in general from avoidance of line-crossing), we conclude that there may be some merit in exploring more dramatic shifts in the character of phonological representation than have previously been entertained.

Bibliography

- Akinlabi, Akinbiyi (1984) *Tonal Underspecification and Yoruba Tone*. Doctoral dissertation, University of Ibadan.
- Akinlabi, Akinbiyi and Eno Urua (1993) Prosodic Targets and vocalic specification in Ibibio verbs. *WCCFL* 11, 1-14.
- Akinlabi, Akinbiyi (1995) Prosodic Truncation and Template Satisfaction in Ibibio Verbs. In Kola Owolabi, ed., *Language in Nigeria: a Festschrift for Ayo Bamgbose*. Group Publishers: Ibadan, pp. 75-90.
- Alderete, John, Jill Beckman, Laura Benua, Amalia Gnanadesikan, John McCarthy, & Suzanne Urbanczyk (1996) Reduplication and segmental unmarkedness. Ms., UMass Amherst. ROA-134, Rutgers Optimality Archive, <http://ruccs.rutgers.edu/roa.html>.
- Anderson, Stephen R. (1972) On nasalization in Sundanese. *Linguistic Inquiry*, 3, 253–268.
- Anderson, Stephen R. (1992) *A-Morphous Morphology*. Cambridge: Cambridge University Press.
- Andrade, M. (1933) *Quileute*. New York: Columbia University Press.
- Apte, Mahadeo (1968) *Reduplication, echo formation, and onomatopoeia in Marathi*. Poona: Deccan College, Postgraduate and Research Institute.
- Applegate, Richard B. (1976) Reduplication in Chumash. In Margaret Langdon & Shirley Silver, eds., *Hokan Studies*. The Hague: Mouton. Pp. 271–283.
- Archangeli, Diana (1983) The root CV-template as a property of the affix: Evidence from Yawelmani. *Natural Language & Linguistic Theory*, 1, 348–384.
- Archangeli, Diana (1984) *Underspecification in Yawelmani Phonology and Morphology*. Doctoral dissertation, MIT, Cambridge, MA.
- Archangeli, Diana (1991) Syllabification and prosodic templates in Yawelmani. *Natural Language & Linguistic Theory*, 9, 231–284.
- Archangeli, Diana & Douglas Pulleyblank (1986) *The Content and Structure of Phonological Representations*. Ms., University of Arizona and University of British Columbia.
- Archangeli, Diana & Douglas Pulleyblank (1994) *Grounded Phonology*. Cambridge, MA: MIT Press.
- Aronoff, Mark (1976) *Word Formation in Generative Grammar*. Cambridge, MA: MIT Press.
- Aronoff, Mark (1985) Talk on Makassarese reduplication presented at University of Massachusetts, Amherst.
- Aronoff, Mark (1988) Head operations and strata in reduplication: A linear treatment. *Yearbook of Morphology*, 1, 1–15.
- Aronoff, Mark, Azhar Arsyad, Hassan Basri, & Ellen Broselow (1987) Tier configuration in Makassarese reduplication. In Anna Bosch, Barbara Need and Eric Schiller (eds.), *Papers from the 23rd Annual Regional Meeting of the Chicago Linguistic Society, Part Two: Parasession on Autosegmental and Metrical Phonology* (pp. 1–15). Chicago: Chicago Linguistic Society.
- Austin, Peter (1981) *A Grammar of Diyari, South Australia*. Cambridge: Cambridge University Press.
- Bach, Emmon (1975) Long vowels and stress in Kwakiutl. *Texas Linguistic Forum*.
- Bagemihl, Bruce (1988) The morphology and phonology of Katajjaït (Inuit throat games). *Canadian Journal of Linguistics*, 33, 1–58.
- Bagemihl, Bruce (1989a) The crossing constraint and 'backwards languages'. *Natural Language & Linguistic Theory*, 7, 481–550.
- Bagemihl, Bruce (1989b) *Alternate phonologies and morphologies*. Doctoral dissertation, University of British Columbia, Vancouver.
- Bagemihl, Bruce (1991) Syllable structure in Bella Coola. *Linguistic Inquiry*, 22, 589–646.
- Bao, Zhiming (1990) *Fanqie* languages and reduplication. *Linguistic Inquiry*, 24, 317–350.
- Bat-El, Outi (1989) *Phonology and Word Structure in Modern Hebrew*. Doctoral dissertation, UCLA, Los Angeles.

- Bat-El, Outi (1992) Stem modification and cluster transfer in Modern Hebrew. Ms., Tel-Aviv University, Tel-Aviv.
- Bat-El, Outi (1995) Selecting the best of the worst: The grammar of Hebrew blends. Ms., Tel-Aviv University.
- Bates, Dawn & Barry Carlson (1992) Simple syllables in Spokane Salish. *Linguistic Inquiry*, 23, 653–659.
- Beck, Hanno T. (1983) Grebo verbal morphology. Term paper, University of Texas, Austin.
- Bell, Sarah (1983) Internal C reduplication in Shuswap. *Linguistic Inquiry*, 14, 332–338.
- Benton, Richard (1971) *Pangasinan Reference Grammar*. Honolulu: University of Hawaii Press.
- Benua, Laura (1995) Identity effects in morphological truncation. ROA-74. Rutgers Optimality Archive, <http://ruccs.rutgers.edu/roa.html>. In Jill Beckman, Laura Walsh Dickey, & Suzanne Urbanczyk, eds., *University of Massachusetts Occasional Papers in Linguistics 18: Papers in Optimality Theory*. Amherst, MA: Graduate Linguistic Student Association. Pp. 77-136.
- Benua, Laura (forthcoming) *Transderivational Identity*. Doctoral dissertation, University of Massachusetts, Amherst.
- Berlin, Brent (1963) Some semantic features of reduplication in Tzeltal. *International Journal of American Linguistics*, 29, 211–218.
- Bernabe, Emma J. Fonacier, Virginia Lapid & Bonifacio Sibayan. (1971) *Ilokano lessons*. Honolulu: University of Hawaii Press.
- Biggs, Bruce (1961) The structure of New Zealand Maaori. *Anthropological Linguistics*, 3, 1–54.
- Black, H. Andrew (1991) The optimal iambic foot and reduplication in Axininca Campa. *Phonology at Santa Cruz*, 2, 1–18.
- Black, H. Andrew (1994) *Constraint-ranked derivation: A serial approach to optimization*. Doctoral dissertation, University of California, Santa Cruz. Pp. 187.
- Blevins, Juliette (1996) Mokilese reduplication. *Linguistic Inquiry* 27.3, 523-530.
- Bliese, Loren F. (1981) *A Generative Grammar of Afar*. The Summer Institute of Linguistics, University of Texas at Arlington.
- Boas, Franz & Ella Deloria (1941) *Dakota Grammar*. Memoirs of the National Academy of Sciences 23. Washington, DC: US Govt. Printing Office.
- Bolozky, Shmuel (1980) On the monophonematic interpretation of Modern Hebrew affricates. *Linguistic Inquiry* 11, 793–9.
- Borowsky, Toni (1986). *Topics in the Lexical Phonology of English*. Doctoral dissertation, University of Massachusetts, Amherst.
- Bowen, J. Donald, ed. (1969). *Beginning Tagalog: A course for speakers of English*. Berkeley: University of California Press.
- Boxwell, H. & M. Boxwell (1966) Weri phonemes. *Papers in New Guinea Linguistics* 5, 77–93.
- Breen, Gavan (1990) The syllable in Arrernte phonology. Ms., School of Australian Linguistics and IAD (Institute for Aboriginal Development).
- Broadbent, Sylvia (1964) *The Southern Sierra Miwok Language*. University of California Publications in Linguistics. Berkeley: University of California Press.
- Bromberger, Sylvain & Morris Halle (1988) Conceptual issues in morphology. Ms., MIT, Cambridge, MA.
- Broselow, Ellen (1982) On the interaction of stress and epenthesis. *Glossa*, 16, 115–132.
- Broselow, Ellen (1983) Subjacency in morphology: Salish double reduplications. *Natural Language & Linguistic Theory*, 1, 317–346.
- Broselow, Ellen (1984). Default consonants in Amharic morphology. In M. Speas and R. Sproat (eds.), *Papers from the January 1984 MIT Workshop in Morphology* (pp. 15– 32). Cambridge MA: MIT Dept. of Linguistics.
- Broselow, Ellen & John McCarthy (1983–4) A theory of internal reduplication. *The Linguistic Review*, 3, 25–88.
- Buckley, Eugene (1994) Alignment in Manam stress. Ms., University of Pennsylvania. ROA-56, Rutgers Optimality Archive, <http://ruccs.rutgers.edu/roa.html>.

- Buller, Barbara, Ernest Buller, and Daniel Everett (1993) Stress Placement, Syllable Structure, and Minimality in Banawa. *IJAL* 59:3, 280-293.
- Bullock, Barbara (1990) V/C planar segregation and the CVC syllable in Sierra Miwok nonconcatenative morphology. In Michael Ziolkowski et al. (eds.), *Papers from the 26th Regional Meeting of the Chicago Linguistic Society, Volume 2: The Parasession on the Syllable in Phonetics and Phonology* (pp. 17–32). Chicago: Chicago Linguistic Society.
- Burzio, Luigi (1996) Multiple Correspondence. Paper presented at the BCN Workshop on Conflicting Constraints, Groningen, July 5, 1996. Ms. Johns Hopkins University: Baltimore.
- Cabré, Teresa and Michael Kenstowicz (1995) Prosodic Trapping in Catalan. ROA-32, Rutgers Optimality Archive, <http://rucss.rutgers.edu/roa.html>. *Linguistic Inquiry* 26.4, 694-705.
- Carleton, Troi & Scott Myers (1994) On tonal transfer. ROA-16, Rutgers Optimality Archive, <http://rucss.rutgers.edu/roa.html>. To appear in Proceedings of CAL 1993.
- Carleton, Troi & Scott Myers (1995) Tonal transfer in Chichewa. To appear in *Phonology*.
- Carrier, Jill (1979) *The Interaction of Phonological and Morphological Rules in Tagalog: A Study in the Relationship between Rule Components in Grammar*. Doctoral dissertation, MIT, Cambridge, MA.
- Carrier-Duncan, Jill (1984) Some problems with prosodic accounts of reduplication. In Mark Aronoff and Richard Oehrle (eds.), *Language Sound Structure* (pp. 260–286). Cambridge, MA: MIT Press.
- Chaski, Carole E. (1986) Linear and metrical analyses of Manam stress. *Oceanic Linguistics*, 25, 167-209.
- Chiang, Wen-yu (1992) *The Prosodic Morphology and Phonology of Affixation in Taiwanese and Other Chinese Languages*. Doctoral dissertation, University of Delaware.
- Cho, Young-mee Yu (1992) A phonological constraint on the attachment of particles in Korean. To appear in *Harvard Studies in Korean Linguistics*, 4.
- Chung, Sandra (1978) *Case marking and grammatical relation in Polynesian*. Austin: University of Texas Press.
- Clements, G. N. (1985a) The problem of transfer in nonlinear morphology. *Cornell Working Papers in Linguistics*, 7, 38–73.
- Clements, G. N. (1985b). The geometry of phonological features. *Phonology Yearbook*, 2, 225– 252.
- Clements, G. N. & Kevin Ford (1979) Kikuyu tone shift and its synchronic consequences. *Linguistic Inquiry*, 10, 179–210.
- Clements, G. N. & S. J. Keyser (1983) *CV Phonology*. Cambridge, MA: MIT Press.
- Cohn, Abigail C. (1992) The consequences of dissimilation in Sundanese. *Working Papers of the Cornell Phonetics Laboratory*, 7, 17–40. [Revised version appeared (1992) in *Phonology*, 9, 199–220.]
- Cohn, Abigail & John McCarthy (1994) Alignment and parallelism in Indonesian phonology. Ms., Cornell University and University of Massachusetts, Amherst. Pp. 73. ROA-25, Rutgers Optimality Archive, <http://rucss.rutgers.edu/roa.html>.
- Cole, Jennifer Fitzpatrick (1990) The minimal word in Bengali. In Aaron Halpern (ed.), *The Proceedings of the Ninth West Coast Conference on Formal Linguistics* (pp. 157–170). Stanford, CA: Stanford Linguistics Association.
- Cole, Jennifer Fitzpatrick (1991) Phrasal reduplication in Bengali. To appear in *Proceedings of the Third Leiden Conference of Junior Linguists*. Leiden: University of Leiden.
- Cowper, Elizabeth & Keren Rice (1985) Phonology and reduplication. Ms., University of Toronto. Presented at June, 1985 Canadian Linguistic Association meeting.
- Cowper, Elizabeth & Keren Rice (1987) Are phonosyntactic rules necessary? *Phonology Yearbook*, 4, 185–194.
- Crowhurst, Megan (1991a) *Minimality and Foot Structure in Metrical Phonology and Prosodic Morphology*. Doctoral dissertation, University of Arizona, Tucson.
- Crowhurst, Megan (1991b) Demorafication in Tübatulabal: Evidence from initial reduplication and stress. In Tim Sherer (ed.), *Proceedings of North East Linguistic Society 21* (pp. 49–64). Amherst, MA: Graduate Linguistic Student Association, University of Massachusetts.

- Crowhurst, Megan (1992a) Diminutives and augmentatives in Mexican Spanish: A prosodic analysis. *Phonology*, 9, 221–253.
- Crowhurst, Megan (1992b) The minimal foot and epenthesis in Sierra Miwok. Ms., University of Texas, Austin.
- Crowhurst, Megan (to appear) Foot extrametricality and template mapping in Cupeño. *Natural Language & Linguistic Theory*.
- Crowley, Terry (1983). Uradhi. In R. M. W. Dixon & B. Blake (eds.), *The Handbook of Australian Languages* vol. 3. Melbourne: OUP Australia.
- Davis, Stuart (1985a). Syllable weight in some Australian languages. In M. Niepokuj, M. VanClay, V. Nikiforidou & D. Feder (eds.), *Papers from BLS 11* (pp. 398–407). Berkeley: Berkeley Linguistics Society.
- Davis, Stuart (1985b). *Topics in syllable geometry*. Doctoral dissertation, University of Arizona, Tucson.
- Davis (1986) Published as Davis (1988a).
- Davis, Stuart (1988a) On the nature of internal reduplication. In Michael Hammond & Michael Noonan (eds.), *Theoretical Morphology: Approaches in Modern Linguistics* (pp. 305–323). San Diego: Academic Press.
- Davis, Stuart (1988b). Syllable onsets as a factor in stress rules. *Phonology*, 5, 1–19.
- Davis, Stuart (1990) Evidence for the full copy analysis of reduplication. Ms., Indiana University, Bloomington.
- de Haas, Wim (1988). *A Formal Theory of Vowel Coalescence: A Case Study of Ancient Greek*. *Publications in Language Sciences* 30. Dordrecht: Foris.
- de Reuse, Willem J. (n.d.) The derivation of Spanish hypocoristics in a nonconcatenative theory of morphology. Ms., University of Texas, Austin.
- de Lacy, Paul (1996) Circumscription revisited: An analysis of Maori reduplication. ROA-133, Rutgers Optimality Archive, <http://ruccs.rutgers.edu/roa.html>.
- Dell, François (1985) A propos de Svantesson, J.-O., *Kammu Phonology and Morphology*. *Cahiers de Linguistique Asie Orientale*, 14, 259–275.
- Dell, François & Mohamed Elmedlaoui (1992) Quantitative transfer in the nonconcatenative morphology of Imdlawn Tashlhiyt Berber. *Journal of Afroasiatic Languages*, 3, 89–125.
- DeCamp, David (1974) Neutralizations, iteratives, and ideophones: The locus of language in Jamaica. In David DeCamp & Ian Hancock (eds.), *Pidgins and Creoles: Current Trends and Prospects*. Washington, DC: Georgetown University Press.
- Dixon, R. M. W. (1972) *The Dyirbal Language of North Queensland*. Cambridge: Cambridge University Press.
- Dixon, R. M. W. (1977) *A Grammar of Yidinʷ*. Cambridge: Cambridge University Press.
- Dixon, R. M. W. (1988) *A Grammar of Boumaa Fijian*. Chicago: University of Chicago Press.
- Doron, Edit (1981) Spirantization melodies: A prosodic treatment of Modern Hebrew spirantization. Ms., University of Texas, Austin.
- Downing, Laura (1994). SiSwati verbal reduplication and the theory of Generalized Alignment. In Mercè González (ed.) *Proceedings of the North East Linguistic Society 24*, 81–95. Amherst, MA: Graduate Student Linguistic Association.
- Downing, Laura J. (1994) SiSwati verbal reduplication and the theory of Generalized Alignment. In Mercè González (ed.), *Proceedings of the North-East Linguistics Society 24*. Pp. 81–95. Amherst, MA: Graduate Linguistic Student Association.
- Downing, Laura J. (1995a) On the prosodic misalignment of onsetless syllables. Ms., University of Pennsylvania.
- Downing, Laura J. (1995b) On the extraprosodicity of onsetless syllables. Ms., University of Pennsylvania.
- Downing, Laura J. (1996) Prosodic misalignment and reduplication. Ms., University of Pennsylvania. Presented at January, 1996, LSA meeting.
- Dresher, B. Elan (1983). Postlexical phonology in Tiberian Hebrew. In M. Barlow, D. Flickinger & M. Wescoat (eds.), *Proceedings of WCCFL 2* (pp. 67–78). Stanford: Stanford Linguistics Association.

- Dunlap, Elaine (1991) *Issues in the Moraic Structure of Spanish*. Doctoral dissertation, University of Massachusetts, Amherst.
- Duryea, David (1991) Issues in Thai template morphology: Word chains and word reversal. *Phonology at Santa Cruz*, 2, 33–58.
- Emeneau, Murray (1955) *The Kolami Language*. Berkeley: University of California Press.
- Everett, Dan & K. Everett (1984). On the relevance of syllable onsets to stress placement. *Linguistic Inquiry*, 15, 705–711.
- Everett, Dan & Lucy Seki (1985) Reduplication and CV skeleta in Kamaiurá. *Linguistic Inquiry*, 16, 326–330.
- Finer, Daniel (1985) Reduplication and verbal morphology in Palauan. *The Linguistic Review*, 6, 99–130.
- Flemming, Edward & Michael Kenstowicz (1995) Base-identity and uniform exponence: Alternatives to cyclicity. Ms., MIT.
- Fleisch, Henri (1968) *L'arabe classique*. Beirut: Khayats.
- Freeland, Lynn S. (1951) *The Language of the Sierra Miwok*. *International Journal of American Linguistics*, Memoir 6. Bloomington, IN: Indiana University.
- French, Koleen Matsuda (1988) *Insights into Tagalog Reduplication, Infixation and Stress from Non-Linear Phonology*. MA Thesis, University of Texas, Arlington.
- Gafos, Adamantios (1995) On the proper characterization of ‘nonconcatenative’ languages. Ms., Johns Hopkins University. ROA-106, Rutgers Optimality Archive, <http://ruccs.rutgers.edu/roa.html>.
- Gafos, Adamantios (1996) *The Articulatory Basis of Locality in Phonology*. Doctoral dissertation, The Johns Hopkins University.
- Goldsmith, John (1976) *Autosegmental Phonology*. Doctoral dissertation, MIT, Cambridge, MA.
- Goldsmith, John (1990) *Autosegmental and Metrical Phonology*. Oxford: Basil Blackwell.
- Golston, Chris (1991) Minimal word, minimal affix. In Tim Sherer (ed.), *Proceedings of the North East Linguistic Society 21* (pp. 95–110). Amherst, MA: Graduate Linguistic Student Association, University of Massachusetts.
- Goodman (1983) Revised and published as Goodman (1988).
- Goodman, Beverley (1988) Takelma verbal morphology. In James Blevins & Juli Carter (eds.), *Proceedings of NELS 18* (pp. 156–174). Amherst, MA: Graduate Linguistic Student Association, University of Massachusetts.
- Goodman, Beverley (1995) *Features in Ponapean Phonology*. Doctoral dissertation, Cornell University, Ithaca, NY.
- Goswami, Upendra (1955-6) Onomatopoeic and echo-words in Kamrupi. *Indian Linguistics* 17, 161–4.
- Grimshaw, Jane (1985) [On dative verbs]. Ms., Brandeis University.
- Guerssel, Mohamed & Jean Lowenstamm (1994) Talk presented at Second Colloquium on Afro-Asiatic Linguistics, Sophia Antipolis, France.
- Haeberlin, H. (1918) Types of reduplication in the Salish dialects. *International Journal of American Linguistics*, 1, 239-253.
- Hale, Kenneth (1973) Deep-surface canonical disparities in relation to analysis and change: An Australian example. *Current Trends in Linguistics*, 11, 401–458.
- Hale, Kenneth & Abanel Lacayo Blanco (1989) *Diccionario Elemental del Ulwa (Sumu Meridional)*. Cambridge, MA: Center for Cognitive Science, MIT.
- Hale, Kenneth & J. White Eagle (1980) A preliminary metrical account of Winnebago accent. *International Journal of American Linguistics*, 46, 117–132.
- Halle, Morris & G.N. Clements (1983) *Problem Book in Phonology: A Workbook for Introductory Courses in Linguistics and in Modern Phonology*. Cambridge: MIT Press.
- Halle, Morris & Michael Kenstowicz (1991) The Free Element Condition and cyclic versus noncyclic stress. *Linguistic Inquiry*, 22, 457–501.
- Halle, Morris & Jean-Roger Vergnaud (1978) Metrical structures in phonology. Ms., MIT, Cambridge, MA.

- Halle, Morris & Jean-Roger Vergnaud (1980) Three-dimensional phonology. *JLR*, 1, 83–105.
- Hammond, Michael (1988) Templatic transfer in Arabic broken plurals. *Natural Language & Linguistic Theory*, 6, 247–270.
- Hammond, Michael (1990) The 'name game' and onset simplification. *Phonology*, 7, 159–162.
- Hammond, Michael (1991) Morphemic circumscription. In Geert Booij & Jaap van Marle (eds.), *Yearbook of Morphology* (pp.195-210). Dordrecht: Kluwer.
- Hammond, Michael (1993) Language games and prosodic circumscription. Ms., University of Arizona, Tucson.
- Harms, Robert T. (1966) The measurement of phonological economy. *Language*, 42, 602–611.
- Harris, James (1979) Some observations on 'Substantive principles in Natural Phonology'. In Daniel Dinnsen (ed.), *Current Approaches to Phonological Theory*. Bloomington: Indiana Univ. Press.
- Harris, James (1985) Spanish word markers. In F. H. Nuessel, Jr. (ed), *Current Issues in Spanish Phonology and Morphology*. Bloomington: Indiana University Linguistics Club.
- Harrison, Sheldon (1976) *Mokilese reference grammar*. With the assistance of Salich Y. Albert. Honolulu: University of Hawaii Press.
- Harrison, Sheldon & Salich Y. Albert (1976) *Mokilese-English Dictionary*. University Press of Hawaii, Honolulu.
- Hart, George (1981) Nasality and the organization of autosegmental phonology. Bloomington: Indiana University Linguistics Club.
- Hayes, Bruce (1980) *A metrical theory of stress rules*. Doctoral dissertation, MIT, Cambridge, MA. Distributed by the Indiana University Linguistics Club. New York: Garland, 1985.
- Hayes, Bruce (1982a) Extrametricality and English stress. *Linguistic Inquiry*, 13, 227-276.
- Hayes, Bruce (1982b) Metrical structure as the organizing principle in Yidin^y phonology. In Harry van der Hulst & Norval Smith (eds.), *The Structure of Phonological Representations, Part 1* (pp. 97–110). Dordrecht: Foris.
- Hayes, Bruce (1983) Talk presented at Sloan Conference on Phonology, University of Massachusetts, Amherst.
- Hayes, Bruce (1985) Iambic and trochaic rhythm in stress rules. In M. Niepokuj et. al. (eds.), *Proceedings of the Thirteenth Meeting of the Berkeley Linguistics Society* (pp. 429–446). Berkeley, CA: Berkeley Linguistics Society.
- Hayes, Bruce (1986) Inalterability in CV phonology. *Language*, 62, 321–251.
- Hayes, Bruce (1987) A revised parametric metrical theory. In J. McDonough & B. Plunkett (eds.), *Proceedings of NELS 17* (pp. 274–289). Amherst, MA: Graduate Linguistic Student Association, University of Massachusetts.
- Hayes, Bruce (1989) Compensatory lengthening in moraic phonology. *Linguistic Inquiry*, 20, 253–306.
- Hayes, Bruce (1991) Published in expanded form as Hayes (1995).
- Hayes, Bruce (1995) *Metrical Stress Theory: Principles and Case Studies*. Chicago: University of Chicago Press.
- Hayes, Bruce & May Abad (1989) Reduplication and syllabification in Ilokano. *Lingua*, 77, 331–374.
- Hayward, R. J. (1988) In defence of the skeletal tier. *Studies in African Linguistics*, 19, 131–172.
- Healey, P. M. (1960) *An Agta Grammar*. Manila: Summer Institute of Linguistics.
- Healey, Alan, Ambrose Isoroembo, & Martin Chittleborough (1969) Preliminary Notes on Orokaiva Grammar, *Papers in New Guinea Linguistics* 9, 33-64.
- Heath, Jeffrey (1981) Tübatulabal phonology. In G. N Clements (ed.), *Harvard Studies in Phonology II*. Bloomington: Indiana University Linguistics Club.
- Henderson, John (forthcoming) Number-marking in Arrernte verbs. Ms., University of Western Australia. Paper presented at Australian Linguistic Society Annual Conference, Macquarie University, North Ryde, 1990.
- Hess, T. (1966) Snohomish chameleon morphology, *International Journal of American Linguistics*, 32, 350-356.

- Hewitt, Mark (1992) *Vertical Maximization and Metrical Theory*. Doctoral dissertation, Brandeis University, Waltham, MA.
- Hewitt, Mark (1995) Single segment reduplication in Optimality Theory. Ms., UBC/Brandeis University.
- Hewitt, Mark & Alan Prince (1989) OCP, locality, and linking: The N. Karanga verb. In E. Jane Fee & K. Hunt eds., *Proceedings of the Eighth WCCFL* (pp. 176–191). Stanford, CA: Stanford Linguistics Association.
- Hill, Jane (1970) A peeking rule in Cupeño. *Linguistic Inquiry*, 1, 534–539.
- Hill, Jane & Ofelia Zepeda (1992) Derived words in Tohono O'odham. *International Journal of American Linguistics*, 58, 355–404.
- Hoberman, Robert (1988) Local and long-distance spreading in Semitic morphology. *Natural Language & Linguistic Theory*, 6, 541–550.
- Hoeksema, Jack (1985) *Categorical Morphology*. New York: Garland Publishing.
- Hohepa, Patrick W. (1967) *A Profile Generative Grammar of Maori*. *International Journal of American Linguistics*, Memoir 20, Indiana University Publications in Anthropology and Linguistics. Bloomington, IN: Indiana University.
- Hualde, Jose (1988). Affricates are not contour segments. In H. Borer (ed.), *Proceedings of WCCFL 7* (pp. 77–89). Stanford: Stanford Linguistics Association.
- Huffman, Franklin (1972) The boundary between the monosyllable and the disyllable in Cambodian. *Lingua*, 29, 54–66.
- Hung, Henrietta (1992) Relativized suffixation in Choctaw: A constraint-based analysis of the verb grade system. Ms., Brandeis University.
- Hyman, Larry (1970) How concrete is phonology? *Language*, 48, 58–76.
- Hyman, Larry (1972) *A Phonological Study of FeʔFeʔ Bamileke*. *Studies in African Linguistics*, Supplement 4.
- Hyman, Larry (1985) *A Theory of Phonological Weight*. Dordrecht: Foris.
- Ingria, Robert (1980) Compensatory lengthening as a metrical phenomenon. *Linguistic Inquiry*, 11, 465–495.
- Inkelas, Sharon (1989) *Prosodic Constituency in the Lexicon*. Doctoral dissertation, Stanford University, Stanford, CA.
- Inkelas, Sharon (1990) Prosodic replacement in Modern Hebrew. In Michael Ziolkowski et al. (eds.), *Papers from the 26th Regional Meeting of the Chicago Linguistic Society, Volume 2: The Parasession on the Syllable in Phonetics and Phonology* (pp. 197–212). Chicago: Chicago Linguistic Society.
- Innes, Gordon (1966) *An Introduction to Grebo*. The Hague: Mouton.
- Itô, Junko (1986) *Syllable Theory in Prosodic Phonology*. Doctoral dissertation, University of Massachusetts, Amherst.
- Itô, Junko (1989) A prosodic theory of epenthesis. *Natural Language & Linguistic Theory*, 7, 217–260.
- Itô, Junko (1991) Prosodic minimality in Japanese. In Karen Deaton, Manuela Noske & Michael Ziolkowski (eds.), *CLS 26-II: Papers from the Parasession on the Syllable in Phonetics and Phonology* (pp. 213–240). Chicago: Chicago Linguistic Society.
- Itô, Junko & Jorge Hankamer (1989) Notes on monosyllabism in Turkish. *Phonology at Santa Cruz*, 1, 61–70.
- Itô, Junko, Yoshihisa Kitagawa & R. Armin Mester (1992) Prosodic type preservation in Japanese: Evidence from *zuuja-go*. SRC-92-05, Syntax Research Center, UC Santa Cruz. ROA-99, Rutgers Optimality Archive, <http://ruccs.rutgers.edu/roa.html>. Published in revised form as Itô, Kitagawa, Mester (1996).
- Itô, Junko, Yoshihisa Kitagawa & R. Armin Mester (1996) Prosodic Faithfulness and Correspondence: Evidence from a Japanese Argot. ROA-146, Rutgers Optimality Archive, <http://ruccs.rutgers.edu/roa.html>. *Journal of East Asian Linguistics* 5, 217–294.
- Itô, Junko & Ralf-Armin Mester (1992) Weak layering and word binarity. Ms., University of California, Santa Cruz.

- Jacobsen, William. (1964) *A Grammar of the Washo Language*, Doctoral dissertation, University of California, Berkeley.
- Jakobson, Roman (1962) *Selected Writings I: Phonological Studies*. Expanded Edition. The Hague: Mouton. [Reference is to: Typological studies and their contribution to historical comparative linguistics. Report in the First Plenary Session of the Eighth International Congress of Linguists, Oslo, 5 August 1957.]
- Janda, Richard & Brian Joseph (1986) One rule or many? Sanskrit reduplication as fragmented affixation. *Ohio State University Working Papers in Linguistics*, 34, 84–107.
- Jensen, John T. (1977). *Yapese Reference Grammar*. Honolulu: University Press of Hawaii.
- Jespersen, Otto (1928-) *A modern English grammar on historical principles*. London: G. Allen & Unwin, Ltd.
- Jun, Jongho (1994) Metrical weight consistency in Korean partial reduplication. *Phonology* 11, 69–88.
- Kager, René (1989) *A Metrical Theory of Stress and Destressing in English and Dutch*. Dordrecht: Foris.
- Kager, René (1992) Are there any truly quantity-insensitive systems?. In Laura Buszard-Welcher, Lionell Wee & William Weigel (eds.) *Proceedings of BLS 18* (pp. 123-132). Berkeley, CA: Berkeley Linguistics Society.
- Kager, René (1993a) Alternatives to the iambic-trochaic law. *Natural Language & Linguistic Theory*.
- Kager, René (1993b) Consequences of Catalexis. Proceedings of HILP-1.
- Kager, René (1993c) Shapes of the generalized trochee. In Jonathan Mead (ed.), *Proceedings of WCCFL 11* (pp. 298-312). Stanford, CA: Stanford Linguistics Association.
- Kager, René (1996a) Stem disyllabicity in Guugu Yimidhirr. OTS-WP-TL-96-008. ROA-70, Rutgers Optimality Archive, <http://ruccs.rutgers.edu/roa.html>. To appear in *HIL Phonology Papers II*, H. van der Hulst and Jeroen van de Weijer, eds. HIL: Leiden.
- Kager, René (1996b) On affix-allomorphy and syllable counting. OTS-WP-TL-96-006. ROA-88, Rutgers Optimality Archive, <http://ruccs.rutgers.edu/roa.html>. To appear in *Interfaces in Phonology*, T. Hall and U. Kleinhenz, eds.
- Katz, Graham (1991) A prosodic circumscription analysis of /gi/-words in Kannada. Term paper for Linguistics 240, 1991 LSA Linguistic Institute Course, University of California, Santa Cruz.
- Kaufman, Terrence (1971) *Tzeltal Phonology and Morphology*. University of California Publications in Linguistics 61. Berkeley: University of California Press.
- Kaye, Jonathan & Jean Lowenstamm (1981/1984) De la syllabicit . In *Forme sonore du langage : structure des representations en phonologie*, F. Dell, D. Hirst, J.-R. Vergnaud, directeurs de la publication. Paris: Hermann, 1984. [Ms. UQAM 2, 1981].
- Kenstowicz, Michael (1977) Rule application in pregenerative American phonology. In Andreas Koutsoudas (ed.), *The ordering and application of phonological rules* (pp. 259-282). The Hague: Mouton. [Repr. in F. Koerner, ed., (1976) *The transformational-generative paradigm and modern linguistic theory*. Amsterdam: Benjamins, 141–174.]
- Kenstowicz, Michael (1979). Chukchee vowel harmony and epenthesis. ROA-30, Rutgers Optimality Archive, <http://ruccs.rutgers.edu/roa.html>. In P. Clyne, W. Hanks & C. Hofbauer (eds.), *CLS 15: The Elements: Parasession on Linguistic Units and Level* (pp. 402–412). Chicago: Chicago Linguistic Society.
- Kenstowicz, Michael (1981). Vowel harmony in Palestinian Arabic: A suprasegmental analysis. *Linguistics*, 19, 449-465.
- Kenstowicz, Michael (1995) Base-identity and uniform exponence: Alternatives to cyclicity. Ms., MIT. ROA-105, Rutgers Optimality Archive, <http://ruccs.rutgers.edu/roa.html>.
- Kim, Young-Seok (1984) *Aspects of Korean morphology*. Doctoral dissertation, University of Texas, Austin.
- Kiparsky, Paul (1982) Lexical phonology and morphology. In I. S. Yang (ed.), *Linguistics in the Morning Calm* vol. 2 (pp. 3–91). Seoul: Hanshin.
- Kiparsky, Paul (1986) *The Phonology of Reduplication*. Ms., Stanford University.
- Kiparsky, Paul (1992) Catalexis. Ms., Stanford University.

- Kirchner, Robert (1992) Lardil truncation and augmentation: A morphological account. Ms., University of Maryland, College Park.
- Kitagawa, Yoshihisa (1985) Published as Kitagawa (1987).
- Kitagawa, Yoshihisa (1987) Redoing reduplication: A preliminary sketch. In Geoffrey J. Huck & Almerindo E. Ojeda (eds.), *Discontinuous Constituency (Syntax and Semantics, Volume 20)*. Orlando: Academic Press.
- Klokeid, Terry (1976) *Topics in Lardil Grammar*. Doctoral dissertation, MIT, Cambridge, MA.
- Kroeger, Paul (1989a) Discontinuous reduplication in vernacular Malay. Paper presented at Berkeley Linguistics Society Meeting, February 20, 1989.
- Kroeger, Paul (1989b) On the nature of reduplicative templates. Ms., Stanford University.
- Lamontagne, Greg (1989) Suffix-triggered variation in Southern Sierra Miwok. Ms., University of Massachusetts, Amherst.
- Lamontagne, Greg & Keren Rice (1995) A correspondence account of coalescence. In Jill Beckman, Laura Walsh Dickey, & Suzanne Urbanczyk, eds., *University of Massachusetts Occasional Papers in Linguistics 18: Papers in Optimality Theory*. Pp. 211-224.
- Laycock, D. (1969) Sublanguages in Buin: Play, poetry, and preservation. In D. Laycock, R. Lloyd & P. Staalsen (eds.), *Papers in New Guinea Linguistics 10*, Pacific Linguistics, Series A, No. 22. Canberra: Australian National University.
- Lee, Borim (1984) A Study on the Autosegmental Tiers - through Akan Reduplication. Master's paper, University of Texas, Austin.
- Lee, Borim (forthcoming [1991]) *Prosodic Structures in Takelma Phonology and Morphology*. Doctoral dissertation, University of Texas, Austin.
- Lee, Jin-Seong & Stuart Davis (1993) A prosodic analysis of infixing reduplication in Korean ideophones. Ms., Indiana University.
- Leslau, Wolf (1950) *Ethiopic Documents: Gurage*. Viking Fund Publications in Anthropology 14. New York: Viking Fund.
- Leslau, Wolf (1964) The jussive in Chaha. *Language*, 40, 53-57.
- Levelt, Clara (1990) Reduplication in Samoan: how to behave as a plural and other good manners. In John van Lit, René Mulder & Rint Sybesma (eds), *Proceedings of the 2nd Leiden Conference for Junior Linguists*, University of Leiden, Leiden.
- Levergood (1983) Ms., University of Texas, Austin.
- Levergood, Barbara (1987) *Topics in Arusa Phonology and Morphology*. Doctoral dissertation, University of Texas, Austin.
- Levin, Juliette (1983) Reduplication and prosodic structure. Ms., MIT, Cambridge, MA.
- Levin, Juliette (1985) *A Metrical Theory of Syllabicity*. Doctoral dissertation, MIT, Cambridge, MA.
- Levin, Juliette (1989) The autonomy of the skeleton: Evidence from Micronesian. Ms., University of Texas, Austin.
- Lichtenberk, František (1983) *A Grammar of Manam*. Honolulu: University of Hawaii Press.
- Lombardi, Linda (1990). The nonlinear organization of the affricate. *Natural Language & Linguistic Theory*, 8, 375-425.
- Lombardi, Linda & John McCarthy (1991) Prosodic circumscription in Choctaw morphology. *Phonology*, 8, 37-71.
- Lowenstamm, Jean & Jonathan Kaye (1986) Compensatory lengthening in Tiberian Hebrew. In L. Wetzels & E. Sezer (eds.), *Studies in Compensatory Lengthening* (pp. 97-132). Dordrecht: Foris.
- Marantz, Alec (1982) Re reduplication. *Linguistic Inquiry*, 13, 435-482.
- Marantz, Alec (1987) Phonologically induced bracketing paradoxes in full morpheme reduplication. In Megan Crowhurst (ed.), *Proceedings of the Sixth West Coast Conference on Formal Linguistics* (pp. 203-212). Stanford, CA: Stanford Linguistics Association.

- Marlett, Stephen & Joseph Stemberger (1983). Empty consonants in Seri. *Linguistic Inquiry*, 5, 617–639.
- Marsack, C. C. (1962) *Teach Yourself Samoan*. London: Hodder and Stoughton.
- Martin, Jack (1989) Infixation and extrametricality in prosodic morphology: Three rules from Creek. Ms., University of North Texas.
- McCarthy, John (1979) *Formal Problems in Semitic Phonology and Morphology*. Doctoral dissertation, MIT, Cambridge, MA.
- McCarthy, John (1981) A prosodic theory of nonconcatentive morphology. *Linguistic Inquiry*, 12, 373–418.
- McCarthy, John (1982) Prosodic templates, morphemic templates, and morphemic tiers. In H. van der Hulst & N. Smith (eds.), *The Structure of Phonological Representations, Part 1*. Dordrecht: Foris.
- McCarthy, John (1983a) A prosodic account of Arabic broken plurals. In Ivan Dihoff (ed.), *Current Trends in African Linguistics 1* (pp. 289–320). Dordrecht: Foris.
- McCarthy, John (1983b) Morpheme Form and Phonological Representation. Paper presented at Sloan Conference on Hierarchy and Constituency in Phonology. University of Massachusetts, Amherst.
- McCarthy, John (1984a) Ponapean reduplication. Ms., University of Texas, Austin.
- McCarthy, John (1984b) Speech disguise and phonological representation in Amharic. In H. van der Hulst & N. Smith (eds.), *Advances in Nonlinear Phonology* (pp. 305–312). Dordrecht: Foris.
- McCarthy, John (1984c) Prosodic organization in morphology. In M. Aronoff and R. Oehrle (eds.), *Language Sound Structure* (pp. 299–317). Cambridge, MA: MIT Press.
- McCarthy, John (1985) Features and tiers: The structure of Semitic roots. Talk presented at MIT, Cambridge, MA.
- McCarthy, John (1986) OCP Effects: Gemination and antigemination. *Linguistic Inquiry*, 17, 207–263.
- McCarthy, John (1989) Linear order in phonological representation. *Linguistic Inquiry*, 20, 71–99.
- McCarthy, John (1991) L'infixation reduplicative dans les langues secrets. *Langages*, 101, 11–29.
- McCarthy, John (1993) Template form in prosodic morphology. In Laurel Smith Stvan et al. (eds.), *Papers from the Third Annual Formal Linguistics Society of Midamerica Conference*. Bloomington, IN: Indiana University Linguistics Club.
- McCarthy, John (1996) Extensions of faithfulness: Rotuman revisited. Ms., University of Massachusetts, Amherst. ROA-110, Rutgers Optimality Archive, <http://ruccs.rutgers.edu/roa.html>.
- McCarthy, John & Alan Prince (1988) Quantitative transfer in reduplicative and templatic morphology. In Linguistic Society of Korea (ed.), *Linguistics in the Morning Calm*, 2 (pp. 3–35). Seoul: Hanshin Publishing Co.
- McCarthy, John & Alan Prince (1990a) Foot and word in prosodic morphology: The Arabic broken plurals. *Natural Language & Linguistic Theory*, 8, 209–282.
- McCarthy, John & Alan Prince (1990b) Prosodic morphology and templatic morphology. In M. Eid & J. McCarthy (eds.), *Perspectives on Arabic Linguistics: Papers from the Second Symposium* (pp. 1–54). Amsterdam: Benjamins, Amsterdam.
- McCarthy, John & Alan Prince (1991a) Prosodic minimality. Paper presented at University of Illinois Conference *The Organization of Phonology*.
- McCarthy, John & Alan Prince (1991b) *Linguistics 240: Prosodic Morphology*. Lectures and handouts from 1991 LSA Linguistic Institute Course, University of California, Santa Cruz.
- McCarthy, John and Alan Prince (1993a) *Prosodic Morphology I: Constraint Interaction and Satisfaction*. Ms., University of Massachusetts, Amherst, and Rutgers University.
- McCarthy, John & Alan Prince (1993b) Generalized alignment. In Geert Booij & Jaap van Marle (eds.), *Yearbook of Morphology 1993* (pp. 79–153). Dordrecht: Kluwer.
- McCarthy, John & Alan Prince (1994a) The emergence of the unmarked: Optimality in Prosodic Morphology. ROA-13. Rutgers Optimality Archive, <http://ruccs.rutgers.edu/roa.html>. In Mercè González (ed.), *Proceedings of the North East Linguistics Society 24* (pp. 333–379). Amherst, MA: Graduate Linguistic Student Association.

- McCarthy, John & Alan Prince (1994b) Two Lectures on Prosodic Morphology. The Utrecht Workshop on Prosodic Morphology. ROA-59, Rutgers Optimality Archive, <http://ruccs.rutgers.edu/roa.html>.
- McCarthy, John & Alan Prince (1995a) Prosodic Morphology. In John Goldsmith (ed.), *A Handbook of Phonological Theory* (pp. 318-366). Basil Blackwell, Oxford.
- McCarthy, John & Alan Prince (1995b) Faithfulness and Reduplicative Identity. ROA-60, Rutgers Optimality Archive, <http://ruccs.rutgers.edu/roa.html>. In Jill Beckman, Suzanne Urbanczyk, & Laura Walsh, (eds.) *University of Massachusetts Occasional Papers in Linguistics 18: Papers in Optimality Theory* (pp. 249-384). Amherst, MA: Graduate Linguistic Student Association.
- McCawley, James (1969) Length and voicing in Tübatulabal. *Proceedings of the CLS 5*.
- McDonough, Joyce (1990) *Topics in the Phonology and Morphology of Navajo*. Doctoral dissertation, University of Massachusetts, Amherst.
- McNally, Louise (1990) Multiplanar reduplication: Evidence from Sesotho. In Aaron Halpern (ed.), *The Proceedings of the Ninth West Coast Conference on Formal Linguistics* (pp. 331-346). Stanford, CA: Stanford, CA: Stanford Linguistics Association, CA.
- Merlan, Francesca (1982) *Mangarayi*. Lingua Descriptive Series 4. Amsterdam: North-Holland.
- Mester, Ralf-Armin (1986) *Studies in Tier Structure*. Doctoral dissertation, University of Massachusetts, Amherst.
- Mester, Ralf-Armin (1990) Patterns of truncation. *Linguistic Inquiry*, 21, 478-485.
- Mester, Ralf-Armin (1995) The quantitative trochee in Latin. *Natural Language & Linguistic Theory* 12, 1-61.
- Michelson, Karin (1981) Stress, epenthesis, and syllable structure in Mohawk. In G. N. Clements (ed.), *Harvard Studies in Phonology II*. Bloomington, IN: Indiana University Linguistics Club.
- Miner, Kenneth L. (1979) Dorsey's Law in Winnebago-Chiwere and Winnebago Accent. *International Journal of American Linguistics*, 45, 25-33.
- Montler, Timothy (1989) Infixation, reduplication, and metathesis in the Saanich actual aspect. *Southwest Journal of Linguistics*, 9(1).
- Montler, Timothy R. & Heather K. Hardy (1988) Imperfective gemination in Alabama. *International Journal of American Linguistics*, 54, 399-415.
- Montler, Timothy R. & Heather K. Hardy (1991) The phonology of negation in Alabama. *International Journal of American Linguistics*, 57, 1-23.
- Moore, John (1989) Doubled verbs in Modern Standard Arabic. *Phonology at Santa Cruz*, 1, 93-124.
- Moravcsik, Edith (1977) *On Rules of Infixing*. Bloomington, IN: Indiana University Linguistics Club.
- Moravcsik, Edith (1978) Reduplicative constructions. In Joseph Greenberg, Charles Ferguson & Edith Moravcsik (eds.), *Universals of Human Language 3: Word Structure* (pp. 297-334). Stanford, CA: Stanford University Press.
- Morris, Mitzi (1989) Swedish nickname formation. *Phonology at Santa Cruz*, 1, 125-171.
- Munro, Pamela & P. Benson (1973) Reduplication and rule ordering in Luiseño. *International Journal of American Linguistics*, 39, 15-21.
- Mutaka, Ngeesimo & Larry Hyman (1990) Syllable and morpheme integrity in Kinande reduplication. *Phonology*, 7, 73-120.
- Myers, Scott (1987) *Tone and the Structure of Words in Shona*. Doctoral dissertation, University of Massachusetts, Amherst.
- Nash, David (1979-80) Yidin^y stress: a metrical account. *Cunyforum*, 7/8, 112-130.
- Nash, David (1980) *Topics in Warlpiri Grammar*. Doctoral dissertation, MIT, Cambridge, MA. New York: Garland, 1986.
- Newman, Stanley (1944) *The Yokuts Language of California*. New York: Viking Fund Publications in Anthropology.
- Newman, Stanley (1947) Bella Coola I: Phonology. *International Journal of American Linguistics*, 13, 129-134.

- Newman, Stanley (1965) *Zuni Grammar*. Albuquerque: University of New Mexico Press.
- Nicklas, Thurston (1974) *The Elements of Choctaw*. Doctoral dissertation, University of Michigan, Ann Arbor.
- Nicklas, Thurston (1975) Choctaw morphophonemics. In James Crawford (ed.), *Studies in Southeastern Indian Languages*. Athens, GA: University of Georgia Press.
- Nivens, Richard (1992) A lexical phonology of West Tarangan. In Donald Burquest & Wyn Laidig (eds.), *Phonological Studies in Four Languages of Maluku*. Dallas: Summer Institute of Linguistics.
- Noske, Manuela (1991) Metrical structure and reduplication in Turkana. In M. Lionel Bender (ed.), *Proceedings of the Fourth Nilo-Saharan Linguistics Colloquium* (pp. 245-262). Hamburg: Helmut Buske Verlag.
- Odden, David & Mary Odden (1985) Ordered reduplication in Kihehe. *Linguistic Inquiry*, 16, 497-503.
- Ola, Olanike Olajumoke (1995) Optimality in Benue-Congo Prosodic Phonology and Morphology. Doctoral Dissertation, University of British Columbia, Vancouver.
- Orgun, C. Orhan (1995) Correspondence and Identity constraints in two-level OT. WCCFL. ROA-62, Rutgers Optimality Archive, <http://ruccs.rutgers.edu/roa.html>.
- Orgun, C. Orhan (1996) Sign-based morphology: A declarative theory of phonology-morphology interleaving. Ms. UC Berkeley. ROA-62, Rutgers Optimality Archive, <http://ruccs.rutgers.edu/roa.html>.
- Orgun, C. Orhan & Sharon Inkelas (1992) Turkish prosodic minimality. Paper presented at 6th International Conference on Turkish Linguistics, Anadolu University, Eskişehir, Turkey. August, 1992.
- Padgett, Jaye & Máire Ní Chiosáin (1995) Labial attraction in Igbo. Handout of talk presented at Santa Cruz phonology workshop, April 15, 1995.
- Pater, Joe (1995) Austronesian nasal substitution and other NC effects. Ms., McGill University. To appear in René Kager, Harry van der Hulst, and Wim Zonneveld, eds., *The Prosody Morphology Interface*. ROA-92, Rutgers Optimality Archive, <http://ruccs.rutgers.edu/roa.html>.
- Payne, David (1981) *The Phonology and Morphology of Axininca Campa*. Arlington, TX: Summer Institute of Linguistics.
- Perlmutter, David (1992) Pervasive word formation patterns in a grammar. Paper presented at BLS.
- Piggott, Glyne (1992) Satisfying the minimal word. Ms., McGill University, Montréal.
- Plénat, Marc (1984) Toto, fanfa, totor et même guiguite sont des anars. In François Dell et al. (eds.), *Forme sonore du langage* (pp. 161-182). Paris: Hermann.
- Plénat, Marc (1985) Morphologie du Largonji des loucherbems. *Langages*, 78, 73-122.
- Plénat, Marc, Ed., (1991) *Les javanais*. *Langages*, 101.
- Poser, William (1982) Why cases of syllable reduplication are so hard to find. Ms., MIT, Cambridge, MA.
- Poser, William (1984a) Hypocoristic formation in Japanese. In Mark Cobler et al. (eds.), *Proceedings of the Third West Coast Conference on Formal Linguistics* (pp. 218-229). Stanford, CA: Stanford Linguistics Association.
- Poser, William (1984b) *The Phonetics and Phonology of Tone and Intonation in Japanese*, Doctoral dissertation, MIT, Cambridge, MA.
- Poser, William (1986) Diyari stress, metrical structure assignment, and the nature of metrical representation. In M. Dalrymple et al. (eds.), *Proceedings of the West Coast Conference on Formal Linguistics 5*. Stanford, CA: Stanford Linguistics Association.
- Poser, William (1989) The metrical foot in Diyari. *Phonology*, 6, 117-148.
- Poser, William (1985 [1990]) Evidence for foot structure in Japanese. *Language*, 66, 78-105.
- Prentice, D. J. (1971) *The Murut Languages of Sabah*. Pacific Linguistics, Series C, no. 18. Canberra: Australian National University.
- Priest, Perry (1980) *Estudios sobre el idioma siriono*. Riberalta, Bolivia: Instituto Linguístico de Verano.
- Prince, Alan (1975). The phonology and morphology of Tiberian Hebrew. Doctoral dissertation, MIT, Cambridge, MA.
- Prince, Alan (1980) A metrical theory for Estonian quantity. *Linguistic Inquiry*, 11, 511-562.
- Prince, Alan (1983) Relating to the grid. *Linguistic Inquiry*, 14, 19-100.

- Prince, Alan (1984) Phonology with tiers. In M. Aronoff & R. Oehrle (eds.), *Language Sound Structure* (pp. 234-244). Cambridge, MA: MIT Press.
- Prince, Alan (1985) Improving tree theory. *Proceedings of the Berkeley Linguistics Society*, 11, 471-490.
- Prince, Alan (1987) Planes and copying. *Linguistic Inquiry*, 18, 491-510.
- Prince, Alan (1991) Quantitative consequences of rhythmic organization. In Karen Deaton, Manuela Noske & Michael Ziolkowski (eds.), *CLS 26-II: Papers from the Parasession on the Syllable in Phonetics and Phonology* (pp. 355-398). Chicago: Chicago Linguistic Society.
- Prince, Alan & Paul Smolensky (1991a) Optimality. Paper given at Arizona phonology conference.
- Prince, Alan & Paul Smolensky (1991b) Notes on connectionism and harmony theory in linguistics. In *Technical Report CU-CS-533-91*. Department of Computer Science, University of Colorado, Boulder, Colorado.
- Prince, Alan & Paul Smolensky (1992) Optimality: Constraint interaction in generative grammar. Paper read at 12th West Coast Conference on Formal Linguistics, Los Angeles.
- Prince, Alan & Paul Smolensky (1993) *Optimality Theory: Constraint Interaction in Generative Grammar*. Ms., Rutgers University, New Brunswick, and University of Colorado, Boulder.
- Pulleyblank, Douglas (1983) *Tone in Lexical Phonology*. Doctoral dissertation, MIT, Cambridge, MA. [Dordrecht: Reidel, 1986.]
- Pulleyblank, Douglas (1988) Vocalic underspecification in Yoruba. *Linguistic Inquiry*, 19, 233-270.
- Pulleyblank, Douglas (1994) Underlying mora structure. *Linguistic Inquiry*, 25, 344-353.
- Rehg, Kenneth L. & Damien G. Sohl (1981) *Ponapean Reference Grammar*. Honolulu: University of Hawaii Press.
- Reichard, Gladys A. (1959) A comparison of five Salish languages: V. *International Journal of American Linguistics*, 59, 239-253.
- Robins, R. H. (1959) Nominal and verbal derivation in Sundanese. *Lingua*, 8, 337-369.
- Rosenthal, Samuel (1995) The prosodic base of the Hausa plural. In Jill Beckman, Laura Walsh Dickey, & Suzanne Urbanczyk, eds., *University of Massachusetts Occasional Papers in Linguistics 18: Papers in Optimality Theory*. Pp. 421-438. Also to appear in René Kager, Harry van der Hulst, and Wim Zonneveld, eds., *The Prosody Morphology Interface*.
- Rubach, Jerzy (1994) Affricates as strident stops in Polish. *Linguistic Inquiry*, 25, 119-143.
- Sagey, Elizabeth (1986). *The representation of features and relations in nonlinear phonology*. Doctoral dissertation, MIT, Cambridge, MA. New York: Garland Press, 1991.
- Samek-Lodovici, Vieri (1992) Universal constraints and morphological gemination: A crosslinguistic study. Ms., Brandeis University.
- Samek-Lodovici, Vieri (1994) A Unified Analysis of Crosslinguistic Morphological Gemination. In Peter Ackema & Maaike Schoorlemmer (eds.), *Proceedings of CONSOLE I*, The Hague: Holland Academic Graphics, pp.265-283. ROA-149, Rutgers Optimality Archive, <http://rucss.rutgers.edu/roa.html>.
- Sapir, Edward (1922) The Takelma language of southwestern Oregon. In Franz Boas (ed.), *Handbook of American Indian Languages. Bulletin of American Ethnology*, 40(2), 1-296.
- Sapir, Edward (1930) *Southern Paiute, a Shoshonean Language*. Proceedings of the American Academy of Arts and Sciences, 65, no. 1-3.
- Schachter, Paul & Victoria Fromkin (1968) *A Phonology of Akan: Akuapem, Asante, and Fante*. UCLA Working Papers in Phonetics 9.
- Schein, Barry & Donca Steriade (1986). On geminates. *Linguistic Inquiry*, 17, 691- 744.
- Sch lindwein, Deborah (1988) *The Phonological Geometry of Morpheme Concatenation*. Doctoral dissertation, University of Southern California.
- Sch lindwein, Deborah (1991) Reduplication in lexical phonology: Javanese plural reduplication. *The Linguistic Review*, 8, 97-106.

- Scullen, Mary Ellen (1993) *The Prosodic Morphology of French*. Doctoral dissertation, Indiana University, Bloomington.
- Selkirk, Elisabeth (1980a) Prosodic domains in phonology: Sanskrit revisited. In Mark Aronoff & Mary-Louise Kean (eds.), *Juncture* (pp. 107–129). Saratoga, CA: Anna Libri.
- Selkirk, Elisabeth (1980b) The role of prosodic categories in English word stress. *Linguistic Inquiry*, 11, 563–605.
- Selkirk, Elisabeth (1981) "Epenthesis and Degenerate Syllables in Cairene Arabic," in H. Borer & J. Aoun eds., *Theoretical Issues in the Grammar of the Semitic Languages*, MIT, Cambridge, MA.
- Selkirk, Elisabeth (1988) A two-root theory of length. Ms., University of Massachusetts, Amherst.
- Sharvit, Yael (1994) Issues in the Phonology and Morphology of the Modern Hebrew Verbal System: Alignment Constraints in Verb Formation. ROA-23, Rutgers Optimality Archive, <http://rucss.rutgers.edu/roa.html>.
- Shaw, Patricia (1980) *Dakota Phonology and Morphology*. New York: Garland.
- Shaw, Patricia (1987) Non-conservation of melodic structure in reduplication. In Anna Bosch et al. (eds.), *Papers from the 23rd Annual Regional Meeting of the Chicago Linguistic Society, Part Two: Parasession on Autosegmental and Metrical Phonology* (pp. 291–306). Chicago: Chicago Linguistic Society.
- Shaw, Patricia (1992) Templatic evidence for the syllable nucleus. NELS 23 handout, University of Ottawa.
- Sherer, Tim D. (1994) *Prosodic Phonotactics*. ROA-54, Rutgers Optimality Archive, <http://rucss.rutgers.edu/roa.html>. Doctoral dissertation, University of Massachusetts, Amherst.
- Sherzer, Joel (1970) Talking backwards in Cuna: The sociological reality of phonological descriptions. *Southwestern Journal of Anthropology*, 26, 343–353.
- Sherzer, Joel (1975) A problem in Cuna phonology. *The Journal of the Linguistic Association of the Southwest*, 1, 45–53.
- Sherzer, Joel. (1982) Play languages: With a note on ritual languages. In L.K. Obler and L. Menn (eds.), *Exceptional Language and Linguistics* (pp. 175–199). New York: Academic Press.
- Shetler, J. (1976) *Notes on Balangao Grammar*. Summer Institute of Linguistics, Huntington Beach, CA.
- Sietsema, Brian (1988) Reduplication in Dakota. In Lynn MacLeod et al. (eds.), *Papers from the 24th Annual Regional Meeting of the Chicago Linguistic Society* (pp. 337–352). Chicago: Chicago Linguistic Society.
- Silverman, Daniel (1991) The asymmetrical application of phonology and morphological principles in reduplication. Ms., UCLA, Los Angeles, CA.
- Sloan, Kelly (1988) Bare-consonant reduplication: Implications for a prosodic theory of reduplication. In Hagit Borer (ed.), *Proceedings of the Seventh West Coast Conference on Formal Linguistics* (pp. 319–330). Stanford, CA: Stanford Linguistic Association.
- Sloan, Kelly (1991) *Syllables and Templates: Evidence from Southern Sierra Miwok*. Doctoral dissertation, MIT, Cambridge, MA.
- Smith, Norval (1985) Spreading, reduplication, and the default option in Miwok nonconcatenative morphology. In Harry van der Hulst & Norval Smith (eds.), *Advances in Nonlinear Phonology* (pp. 363–380). Dordrecht: Foris.
- Smith, Norval (1986) Reduplication, spreading and/or empty suffix slots in Sierra Miwok associative morphology. In Hans Bennis & F. Beckema (eds.), *Linguistics in the Netherlands 1986* (pp. 235–243). Dordrecht: Foris.
- Smith, Norval & Ben Hermans (1982) Nonconcatenatieve woordvorming in het Sierra Miwok. *Glott*, 5, 263–284.
- Sommer, Bruce (1981) The shape of Kunjen syllables. In D. L. Goyvaerts (ed.), *Phonology in the 1980's*. Ghent: E. Story-Scientia.

- Spring, Cari (1990a) *Implications of Axininca Campa for Prosodic Morphology and Reduplication*. Doctoral dissertation, University of Arizona, Tucson.
- Spring, Cari (1990b) How many feet per language? In Aaron Halpern (ed.), *The Proceedings of the Ninth West Coast Conference on Formal Linguistics* (pp. 493–508). Stanford, CA: Stanford Linguistics Association.
- Spring, Cari (1990c) Unordered morphology: The problem of Axininca reduplication. In David J. Costa (ed.), *Proceedings of the Sixteenth Annual Meeting of the Berkeley Linguistics Society* (pp. 137–157). Berkeley, CA: Berkeley Linguistics Society.
- Spring, Cari (1992) Maximization as association. Ms., Ohio State University.
- Steriade, Donca (1982). *Greek prosodies and the nature of syllabification*. Doctoral dissertation, MIT, Cambridge, MA.
- Steriade, Donca (1985) Reduplication, ablaut, and syllabicity in Sanskrit. Ms., MIT, Cambridge, MA.
- Steriade, Donca (1986) Yokuts and the vowel plane. *Linguistic Inquiry*, 17, 129–146.
- Steriade, Donca (1987) Reduplication and syllable transfer. Ms., MIT, Cambridge, MA.
- Steriade, Donca (1988) Reduplication and syllable transfer in Sanskrit and elsewhere. *Phonology*, 5, 73–155.
- Steriade, Donca (1990) Gestures and Autosegments: comments on Browman and Goldstein's paper. In John Kingston & Mary Beckman, eds., *Between the grammar and the physics of speech: Papers in laboratory phonology 1*, pp. 382–397. New York: Cambridge University Press.
- Steriade, Donca (1993). Closure, release and nasal contours. In M. Huffman & R. Krakow (eds.), *Nasality*. San Diego: Academic Press.
- Stevens, Alan (1968) *Madurese Phonology and Morphology*. American Oriental Society, New Haven.
- Stonham, John (1990) *Current Issues in Morphological Theory*. Doctoral dissertation, Stanford University, Stanford, CA.
- Swadesh, Morris & Charles Voegelin (1939) A problem in phonological alternation. *Language*, 15, 1–10.
- Tateishi, Koichi (1985 [1989]) Theoretical implications of the Japanese musician's language. In E. Jane Fee & Katherine Hunt (eds.), *Proceedings of the Eighth West Coast Conference on Formal Linguistics* (pp. 384–398). Stanford, CA: Stanford Linguistics Association.
- Thompson, Laurence & M. Terry Thompson (1981) Affective derivatives in Thompson River Salish. *University of Hawaii Working Papers in Linguistics*, 13, 119–127.
- Thun, Nils (1963) *Reduplicative Words in English; a study of formations of the types tick-tick, hurly-burly, and shilly-shally*. Uppsala.
- Topping, D. (1973) *Chamorro Reference Grammar*. Honolulu: University Press of Hawaii.
- Topping, D. (1980) *Spoken Chamorro*. Honolulu: University Press of Hawaii.
- Tuggy, David H. (1979) Tetelcingo Nahuatl. In Ronald W. Langacker (ed.), *Studies in Uto-Aztecan Grammar Volume 2: Modern Aztec Grammatical Sketches* (pp. 1–140). Arlington, TX: SIL.
- Turner, Margaret Mary & Gavan Breen (1984) Akarre Rabbit Talk. [NB: Breen identifies the language as Eastern Arrernte rather than Akarre, p.c.]. *Language in Central Australia*, no.1, 10–13.
- Uhrbach, Amy (1985) Some Facts of Reduplication in Bahasa Indonesia with Implications for a Theory of Morphology. Ms., University of Texas, Austin.
- Uhrbach, Amy (forthcoming) Published as Uhrbach (1987).
- Uhrbach, Amy (forthcoming [1987]) *A Formal Analysis of Reduplication and its Interaction with Phonological and Morphological Processes*. Doctoral dissertation, University of Texas, Austin.
- Ulrich, Charles (1986) *Choctaw Morphophonology*. Doctoral dissertation, UCLA, Los Angeles, CA.
- Ulrich, Charles (1992) A unified account of Choctaw intensives. To appear in Proceedings of the 1992 Canadian Linguistic Association Annual Conference, *Toronto Working Papers in Linguistics*.
- Urbanczyk, Suzanne (1992) Infixing and melodic circumscription. Ms., University of Massachusetts, Amherst.

- Urbanczyk, Suzanne (1995) Double reduplications in parallel. In Jill Beckman, Laura Walsh Dickey, & Suzanne Urbanczyk, eds., *University of Massachusetts Occasional Papers in Linguistics* 18: Papers in Optimality Theory. Pp. 499-532. Also to appear in René Kager, Harry van der Hulst, and Wim Zonneveld, eds., *The Prosody Morphology Interface*. ROA-73, Rutgers Optimality Archive, <http://ruccs.rutgers.edu/roa.html>.
- Urbanczyk, Suzanne (1996a) Morphological templates in reduplication. *Proceedings of NELS 26*. Amherst, MA: GLSA.
- Urbanczyk, Suzanne (1996b) *Patterns of Reduplication in Lushootseed*. Doctoral dissertation, UMass Amherst.
- Vago, Robert (1985) The treatment of long vowels in word games. *Phonology Yearbook*, 2, 327–342.
- van der Hulst, Harry (1984) *Syllable Structure and Stress in Dutch*. Dordrecht: Foris.
- Voegelin, Charles (1935) Tübatulabal grammar. *University of California Publications in American Archaeology and Ethnology*, 34, 55-190.
- Walsh, Laura (1992) Tone in reduplication. In C.P. Canakis, G.P. Chan & J.M. Denton (eds.), *Papers from the 28th Regional Meeting of the Chicago Linguistic Society: Main Session* (pp.543-553). Chicago: Chicago Linguistic Society.
- Weeda, Donald (1986 [1987]) Formal properties of Madurese final syllable reduplication. In Anna Bosch et al. (eds.), *Papers from the 23rd Annual Regional Meeting of the Chicago Linguistic Society, Part Two: Parasession on Autosegmental and Metrical Phonology* (pp. 403–417). Chicago: Chicago Linguistic Society.
- Weeda, Donald (1992) *Word Truncation in Prosodic Phonology*. Doctoral dissertation, University of Texas, Austin.
- Wehr, Hans (1971) *A Dictionary of Modern Written Arabic*. Trans. by J Milton Cowan. Ithaca, NY: Spoken Language Services.
- Whitney, W. D. (1889). *Sanskrit Grammar*. Cambridge, MA: Harvard University Press.
- Wiesemann, Ursula (1972) *Die phonologische und grammatische Struktur der Kaingang-sprache*. The Hague: Mouton.
- Wilbur, Ronnie (1974) *The Phonology of Reduplication*, Doctoral dissertation, University of Illinois, Urbana.
- Wilkins, David (1984) Nominal reduplication in Mparntwe Arrernte. *Language in Central Australia*, no. 1, 16-22.
- Wilkins, David (1989) *Mparntwe Arrernte (Aranda): studies in the structure and semantics of grammar*, Doctoral Dissertation, Australian National University: Canberra.
- Wilkinson, Karina (1986) Syllable structure and Lardil phonology. Ms., University of Massachusetts, Amherst.
- Wilkinson, Karina (1988) Prosodic structure and Lardil phonology. *Linguistic Inquiry*, 19, 325–334.
- Williams, Jeffrey (1984) Phonological conditioning in Nakanai reduplication. *Linguistic Analysis*, 14, 173-190.
- Williams, Jeffrey (1991) A note on echo word morphology in Thai and the languages of South and South-East Asia. *Australian Journal of Linguistics*, 11, 107–112.
- Winter, Werner (1970) Reduplication in Washo: A restatement. *International Journal of American Linguistics*, 36, 190-198.
- Woodbury, Anthony (1985) Meaningful phonological processes: A consideration of Central Alaskan Yupik Eskimo prosody. Ms., University of Texas, Austin.
- Yin, Yuen-Mei (1989) *Phonological aspects of word formation in Mandarin Chinese*. Doctoral dissertation, University of Texas, Austin.
- Yip, Moira (1982) Reduplication and CV-skeleta in Chinese secret languages. *Linguistic Inquiry*, 13, 637–662.

- Yip, Moira (1983) Redundancy and the CV-skeleton. Ms., Brandeis University, Waltham, MA.
- Yip, Moira (1988) Template morphology and the direction of association. *Natural Language & Linguistic Theory*, 6, 551–577.
- Yip, Moira (1991) Prosodic morphology of four Chinese dialects. *Journal of East Asian Linguistics*, 1(1).
- Yip, Moira (1992) Reduplication with fixed melodic material. In Kimberley Broderick (ed.), *NELS 22*. Amherst, MA: Graduate Linguistic Student Association.
- Yip, Moira (1993) The interaction of ALIGN, PARSE-Place, and *ECHO in reduplication. ms., University of California, Irvine. Pp. 17.
- Yip, Moira (1995a) Identity avoidance in phonology and morphology. Ms., UC Irvine. To appear in the Proceedings of the Conference on Morphology and its Relation to Syntax and Phonology, UC Davis, May, 1995. ROA-82, Rutgers Optimality Archive, <http://rucss.rutgers.edu/roa.html>.
- Yip, Moira (1995b) Repetition and its avoidance: The case of Javanese. Ms., UC Irvine. To appear in K. Suzuki and D. Elzinga, eds., *Arizona Phonology Conference 4: Features in Optimality Theory*, University of Arizona Coyote Working Papers in Linguistics. ROA-83, Rutgers Optimality Archive, <http://rucss.rutgers.edu/roa.html>.
- Zec, Draga (1988) *Sonority Constraints on Prosodic Structure*. Doctoral dissertation, Stanford University, Stanford, CA.