

2019

Q-Theory Representations are Logically Equivalent to Autosegmental Representations

Nick Danis

Princeton University, ndanis@gmail.com

Adam Jardine

Rutgers University, adam.jardine@rutgers.edu

Follow this and additional works at: <https://scholarworks.umass.edu/scil>

 Part of the [Computational Linguistics Commons](#), and the [Phonetics and Phonology Commons](#)

Recommended Citation

Danis, Nick and Jardine, Adam (2019) "Q-Theory Representations are Logically Equivalent to Autosegmental Representations," *Proceedings of the Society for Computation in Linguistics*: Vol. 2 , Article 5.

DOI: <https://doi.org/10.7275/tvj1-k306>

Available at: <https://scholarworks.umass.edu/scil/vol2/iss1/5>

This Paper is brought to you for free and open access by ScholarWorks@UMass Amherst. It has been accepted for inclusion in Proceedings of the Society for Computation in Linguistics by an authorized editor of ScholarWorks@UMass Amherst. For more information, please contact scholarworks@library.umass.edu.

Q-Theory Representations are logically equivalent to Autosegmental Representations

Nick Danis

Program in Linguistics
Princeton University
ndanis@princeton.edu

Adam Jardine

Department of Linguistics
Rutgers University
adam.jardine@rutgers.edu

Abstract

We use model theory and logical interpretations to systematically compare two competing representational theories in phonology, Q-Theory (Shih and Inkelas, 2014, *forthcoming*) and Autosegmental Phonology (Goldsmith, 1976). We find that, under reasonable assumptions for capturing tone patterns, Q-Theory Representations are equivalent to Autosegmental Representations, in that any constraint that can be written in one theory can be written in another. This contradicts the assertions of Shih and Inkelas, who claim that Q-Theory Representations are different from, and superior to, Autosegmental Representations.

1 Introduction

Model theory and mathematical logic can be used to rigorously define phonological representations and constraints (Bird, 1995; Potts and Pullum, 2002). The logical notion of *interpretation* (Enderton, 1972; Courcelle, 1994; Hodges, 1997) between logics of different kinds of models then allows us to compare and contrast differing representational theories, and rigorously examine whether or not they are truly distinct or if they are simply notational variants of one another (Strother-Garcia and Heinz, 2017).

This paper uses these techniques to critically examine the Q-Theory Representations (QRs) of Shih and Inkelas (*forthcoming*, henceforth SI; see also Shih and Inkelas (2014)). SI argue for QRs as a superior alternative to Autosegmental Representations (ARs; Goldsmith (1976)), specifically with respect to phonological tone patterns. We find that, to the contrary, the differences are notational. We show that for any constraint that can be written in the first-order logic of QRs, there is an equivalent constraint in ARs, and vice versa.

The fundamental idea behind QRs is that every segment, or Q , is divided into three sub-segments, or qs . Agreement and disagreement is based on *correspondence* (Hansson, 2001; Rose and Walker, 2004; Bennett, 2015), a relation that holds between qs and between Qs . To give an example, SI give the following QR in (1a) for the Basaá word [hólól] ‘ripen’ (Dimmendaal, 1988; Hyman, 2003), in which the first vowel is a level high tone and the second vowel is a falling tone. Each [o] vowel Q is split into three qs , which each carry a tone. Indices on the qs represent correspondence. (Consonant qs have been abbreviated.)

- a. h(ó₁ ó_{1,2} ó_{2,3})l(ó₃ ò₄ ò₄)l b. $\begin{array}{c} H \quad L \\ \diagdown \quad / \\ V \quad V \end{array}$ (1)

In (1a), the first q of the second vowel is high-toned while the rest are low-toned; this thus represents the falling contour of the second vowel. Furthermore, the last q of the first vowel and the first q in the second are in correspondence (and both high-toned). This indicates that the falling contour on the second vowel is the result of partial agreement with the high-toned first vowel.

In contrast, ARs would depict [hólól] using separate strings of *autosegments* associated to one another. An AR for [hólól], given in (1b), represents a high (H) tone associated to both the first vowel (V) and the second vowel.

SI make several claims about QRs in favor of ARs. First, they claim that representations like in (1) capture tone patterns without “the special representational machinery of autosegments and association lines” (SI, pp. 18-9). They give a number of analyses which they argue shows that QRs are “better at capturing key tone behaviors” (p. 2).

By precisely studying the nature of these representations, however, we show that QRs are logically equivalent to ARs. First, we give model-

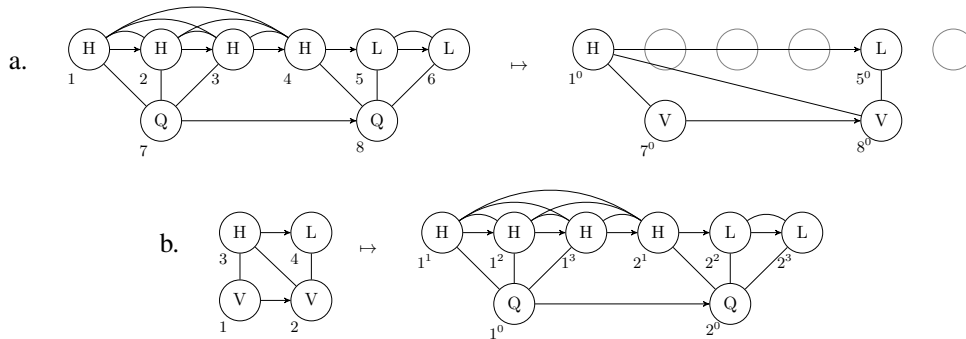

Figure 1: Overview of the transductions (a) from QRs to ARs and (b) from ARs to QRs.

theoretic definitions of both QRs and ARs. This shows that, contra to SI’s claims, QRs *do* require an ‘association’ relation between qs and Qs . Second, based on the logical transductions of [Courcelle \(1994\)](#), we give a *first-order (FO) transduction* from QRs to ARs, and from ARs to QRs. This guarantees that, given any FO statement φ written over QRs, there is an equivalent FO statement φ' in ARs such that any QR model satisfies φ if and only if its equivalent AR model satisfies φ' . In phonological terms, this means that for any constraint that we can write in FO logic of QRs, there is an equivalent constraint in the FO logic of ARs (and vice versa). These models and transductions reveal an equivalence between chains of qs connected by correspondence in QRs and tonal autosegments in ARs.

This paper is not meant to be a complete rebuttal of SI, but instead to lay the formal groundwork for establishing the similarity of QRs and ARs. Throughout, we assume that FO logic as the upper bound for the expressivity necessary to capture constraints in natural language phonology ([Bird, 1995](#); [Rogers et al., 2013](#)).

This paper is structured as follows. §2 summarizes the equivalence between structures in informal terms. §3 gives the preliminaries of model theory and logic; §4 defines ARs and QRs in terms of model theory; and §5 defines the transductions between them. §6 summarizes and discusses the results, and §7 concludes.

2 Overview

Before going into the formal details, we first give a brief overview of how transductions between the two representations proceed. These are illustrated with examples in Fig. 1 showing transductions between models for the representations in (1).

As shown in the left-hand side of Fig. 1a, defining QRs precisely reveals that there must be a relation pairing tone-bearing qs (depicted with Hs and Ls) with vowel Qs . Moving from a QR to an AR, then, is a matter of identifying the first member of a chain of corresponding qs (indicated by curved lines) and as assigning it to a tone in the output AR. All other qs in that chain are ‘merged’ into that autosegment—thus, for example, as both vowel Qs are associated to correspondents of 1 in the QR in Fig. 1a, both equivalent Vs in the AR are associated to its output tone 1^0 .

In the other direction, illustrated in Fig. 1b, we create three additional copies of each V in the AR, representing the output qs . For example, vowel 1 in the left-hand side of Fig. 1b has copies 1^1 , 1^2 , and 1^3 in the right-hand side. These copies are labeled and related through correspondence according to the associations in the AR. For a series of vowels associated to the same tone in the AR, their output Qs are associated to a chain of corresponding qs of the same tone value. For example, both vowels 1 and 2 in the left-hand side of Fig. 1b are associated to the same H tone, so their output Qs are associated to a chain of corresponding H-toned qs in the output. This thus implements the equivalence of tonal autosegments to q -correspondence chains in the transduction from ARs to QRs.

3 Preliminaries

3.1 Models

The following is based on standard concepts of finite relational structures ([Enderton, 1972](#); [Libkin, 2004](#)). A *signature* \mathcal{S} is a fixed set $\{R_1, R_2, \dots, R_n\}$ of n named relations. A *model* M over a signature is a tuple $\langle D; R_1, R_2, \dots, R_n \rangle$ with a domain D of elements and a set of n rela-

tions where each $R_i \subseteq D^k$ for some k . Here, k is equal to either 1 or 2; that is, we consider only unary and binary relations.

For example, the signature $\{<, P_a, P_b\}$ can describe the set of strings over the alphabet a and b . A model in this signature is given in Fig. 2.

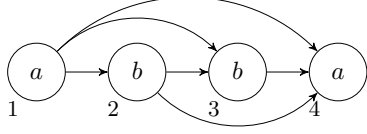

Figure 2: A model of the string $abba$. $D = \{1, 2, 3, 4\}$, P_a and P_b are indicated by labels on the nodes, and $<$ by arrows.

3.2 Logic

A fixed signature induces a first-order (FO) logical language L_S as follows. For every $R_i \in S$, $R_i(x_1, \dots, x_k)$ is an atomic formula in L_S , which is interpreted as true in a model M when x_1, \dots, x_k are evaluated to $d_1, \dots, d_k \in D$ and $(d_1, \dots, d_k) \in R_i$ in M . We also assume an equality predicate $x \approx y$ that is true when x and y are both evaluated to some $i \in D$. We then define the FO logic of L_S and its semantics in the usual way; for details, see, e.g., [Enderton \(1972\)](#). For a FO formula $\varphi(x_1, \dots, x_k)$ we write $M \models \varphi(d_1, \dots, d_k)$ when $\varphi(x_1, \dots, x_k)$ is true in M when x_1, \dots, x_k are evaluated to d_1, \dots, d_k in D . A *sentence* is a formula with no free variables; for a sentence φ we write $M \models \varphi$ when φ is true in M .

3.3 Transductions and interpretations

To directly compare structures in distinct signatures we use logical *transductions* ([Courcelle, 1994](#)), in which the relations in an output structure are defined using the logic of an input structure. Given an input signature S and an output signature $T = \{R_1, \dots, R_n\}$, we define each R_i in L_S . Such a transduction thus induces an *interpretation* of T in S ; that is, for any formula we can write in L_T , there exists a translation into L_S ([Enderton, 1972](#); [Hodges, 1997](#)). If there then also exists a transduction back from T to S , there then exists an interpretation of S in T . If interpretations in both directions exist, we say that S and T are *bi-interpretable*.

A FO transduction is defined as follows. Fix a *copy set* $C = \{1, \dots, k\}$, an input signature S , and an output signature $T = \{R_1, \dots, R_n\}$. A FO

transduction τ from S to T is thus a set of formulae $\varphi_i^{c_1, \dots, c_m}(x_1, \dots, x_m)$ for each $R_i \in T$ and each $c_1, \dots, c_m \in C^m$, where m is the arity of R_i .

The output of such a transduction is calculated as follows.¹ For a structure M over the input signature S , and whose domain is D , $\tau(M)$ is a structure $N = \langle D', R_1, \dots, R_n \rangle$ defined as follows:

1. For every $d \in D$, there is a copy $d^c \in D'$ iff there is exactly one unary predicate $R_i^c(x)$ in τ such that $M \models \varphi_i(d)$.
2. For any R_i of arity m , $(d_1^{c_1}, \dots, d_m^{c_m}) \in R_i$ if and only if there is a $d_1, \dots, d_m \in D^m$ and a $\varphi_i^{c_1, \dots, c_m}(x_1, \dots, x_m)$ in τ such that $M \models \varphi_i^{c_1, \dots, c_m}(d_1, \dots, d_m)$, and each $d_i^{c_i} \in D'$ as per the requirement in (1).

Intuitively, given a structure M over S , the output structure in T can have up to $|C|$ copies of elements in the domain of D , and the relations in T are defined relative to these copies.

For example, given the string signature S defined above we can define a transduction into a pseudo-autosegmental signature $T = \{<', A', P'_c, P'_b\}$ as follows. Set the copy set to $C = \{1, 2\}$. Then define a transduction τ as

$$\begin{aligned} x <'^{1,1} y &\stackrel{\text{def}}{=} x < y \wedge \neg(\exists z)[x < z \wedge z < y], \\ x <'^{2,2} y &\stackrel{\text{def}}{=} x < y \wedge \neg(\exists z)[x < z \wedge z < y], \\ x A'^{1,2} y &\stackrel{\text{def}}{=} x \approx y, \\ P_b'^2(x) &\stackrel{\text{def}}{=} P_b(x), \\ P_c'^1(x) &\stackrel{\text{def}}{=} P_b(x) \vee P_a(x), \end{aligned}$$

and for all other $i, j \in C$, $x <'^{i,j} y \stackrel{\text{def}}{=} x A'^{i,j} y \stackrel{\text{def}}{=} \text{False}$, and $P_b'^1 \stackrel{\text{def}}{=} P_c'^2 \stackrel{\text{def}}{=} \text{False}$.

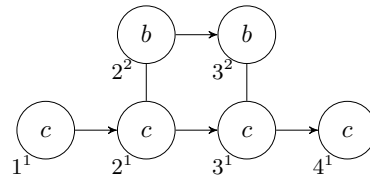

Figure 3: Output structure in T obtained by applying τ to the string model in Fig. 2. Arrows denote $<'$ and lines without arrows denote A' . Indices of the nodes are of the form d^c , where d is a node from Fig. 2 and $c \in C$.

¹We use an abbreviated construction used for those in strings, based on ([Engelfriet and Hoogboom, 2001](#)). For the full construction see ([Courcelle et al., 2012](#)).

We interpret τ as follows; an example is given in Fig. 3. As $P_c^1(x) \stackrel{\text{def}}{=} P_b(x) \vee P_a(x)$, every node d in the input string is given a copy d^1 in the output labeled c . Similarly, as $P_b^2(x) \stackrel{\text{def}}{=} P_b(x)$ means that for any d labeled b in the input, there is a second copy d^2 labeled b in the output. As $P_b^1(x) = P_c^2(x) = \text{False}$, no other copies are produced. Thus, the b nodes in Fig. 2 have both a corresponding c node and b node in Fig. 3, but the a nodes only have a corresponding c node.

The definitions for $x \triangleleft^{1,1} y$ and $x \triangleleft^{2,2} y$ then establish a *successor* relation between the first and second copies of nodes, respectively. Thus, for two nodes d_1 and d_2 in the input structure, d_2^1 is the successor of d_1^1 if and only if $i < j$ in the input structure and no node intervenes between them; likewise for d_1^2 and d_2^2 . As $x \triangleleft^{i,j} y$ is **False** for all other $i, j \in C$, the first and second copies are not ordered with respect to each other. Instead, $x A^{1,2} y \stackrel{\text{def}}{=} x \approx y$ establishes that for any d , d^1 in the output is associated to its own second copy d^2 in the output (assuming that it survives according to (1) above). This can be seen for the copies of the b nodes 2 and 3 from Fig. 2 in Fig. 3.

As such a transduction is defined in terms of the atomic predicates of the output signature, it also induces an interpretation from the logic of the output signature to the logic of the input signature.

Lemma 1 (Courcelle et al. (2012)) *A FO transduction τ from \mathcal{S} to \mathcal{T} induces a translation f from the FO language $L_{\mathcal{S}}$ of \mathcal{S} to the FO language $L_{\mathcal{T}}$ of \mathcal{T} such that for every sentence φ in $L_{\mathcal{S}}$ there is a sentence $f(\varphi)$ in $L_{\mathcal{T}}$ such that for any structure M over \mathcal{S} , $M \models \varphi$ if and only if $\tau(M) \models f(\varphi)$.*

In terms of phonology, if there is a FO transduction from one representational theory \mathcal{S} to another \mathcal{T} , Lemma 1 means that for any FO constraint C over \mathcal{S} there is a FO constraint C' over \mathcal{T} such that a representation in \mathcal{S} satisfies C if and only if its equivalent representation in \mathcal{T} satisfies C' .

4 Phonological representations as models

We now apply this technique to studying the relationship between ARs and QRs. First, we define the representations in model-theoretic terms.

4.1 Autosegmental representations

We assume a basic theory of autosegmental representations (ARs), which also follows SI’s characterization of ARs (p. 2). The crucial assumptions

are that there exists a tier of timing units (in our case, vowels), and featural elements are associated to elements on this tier. Each type of featural element (for our purposes, Hs and Ls) are also on their own tier, ordered together. For the patterns discussed in SI, a single tonal tier is sufficient. The signature for ARs is thus as below.

$$\mathcal{A} = \{\triangleleft_{\mathcal{A}}, A_{\mathcal{A}}, V_{\mathcal{A}}, H_{\mathcal{A}}, L_{\mathcal{A}}\} \quad (2)$$

$V_{\mathcal{A}}$, $H_{\mathcal{A}}$, and $L_{\mathcal{A}}$ are unary relations that label elements as vowels, H tones, and L tones, respectively. The association relation is $A_{\mathcal{A}}$; to simplify definitions we treat $A_{\mathcal{A}}$ as antisymmetric and directed from vowels to tones; that is, $x A_{\mathcal{A}} y$ holds only if $V_{\mathcal{A}}(x)$ is true and either $H_{\mathcal{A}}(y)$ or $L_{\mathcal{A}}(y)$.

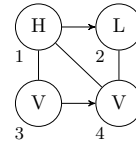

Figure 4: An example AR of the sequence $\hat{V}\hat{V}$.

Each tier is ordered by the $\triangleleft_{\mathcal{A}}$ successor relation. Thus, the set of elements labeled $V_{\mathcal{A}}$ are ordered, as are the set of elements labeled $H_{\mathcal{A}}$ or $L_{\mathcal{A}}$. A vowel can be associated to more than one tone (a contour) or a tone can be associated to more than one vowel (spreading). This is shown in Figure 4. For further simplicity, we also assume full specification: there are no toneless vowels and no floating tones. This last assumption is somewhat generous, as by SI’s own admission, QRs cannot capture floating tones (see SI §6.1).

Next, we assume two axioms that specially require the use of precedence ($<$). The first is No Gapping (NG), which prohibits autosegments from being linked to non-contiguous elements on the timing tier (Ní Chiosáin and Padgett, 2001).

$$\text{NG} \stackrel{\text{def}}{=} (\forall x, y, z, w) [(x < y < z \wedge A_{\mathcal{A}}(x, w) \wedge A_{\mathcal{A}}(z, w)) \rightarrow A_{\mathcal{A}}(y, w)]$$

We also adopt the No-Crossing Constraint (NCC), which states that association must respect precedence on each tier (Goldsmith, 1976).

$$\text{NCC} \stackrel{\text{def}}{=} (\forall x, y, v, w) [(x A_{\mathcal{A}} v \wedge y A_{\mathcal{A}} w \wedge x < y) \rightarrow v < w]$$

Thus, models in \mathcal{A} satisfy $\text{NG} \wedge \text{NCC}$.

Finally, we assume that vowels can only associate to at most three tones—this maintains equivalence between ARs and QRs. While this has not traditionally been explicitly stated as an axiom of ARs, recent proposals do state such constraints (Yli-Jyrä, 2013; Jardine and Heinz, 2015).

4.2 Q-Theory representations

Q-Theory Representations (QRs) consist of two sets of ordered elements: one of Q s, and one of q s. Each Q consists of exactly 3 q s, and every q is part of exactly one Q . According to SI, q s are sub-segments; the featural information of the segment is carried on the q . For our purposes, the relevant features are the tone features H and L. Thus, because constraints in SI refer to the featural information of some Q , it must be able to “see” what q s are relevant; a Q and its q s must be in some relation. We denote this relation A_Q .

We thus consider the following signature for QRs. Fig. 5 gives an example model in this signature of the QR for [hólól] from (1).

$$Q = \{\triangleleft_Q, R_Q, A_Q, Q_Q, H_Q, L_Q\} \quad (3)$$

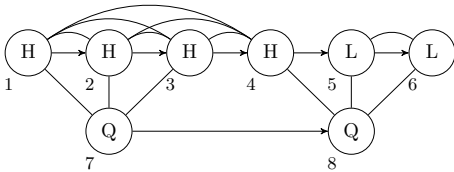

Figure 5: An example QR of the sequence $\hat{V}\hat{V}$.

This signature includes a successor relation \triangleleft_Q , a correspondence relation R_Q (the curved lines in Fig. 5), the relation A_Q associating Q s to q s, and three unary relations Q_Q , H_Q , and L_Q , labeling Q s, H-toned q s, and L-toned q s, respectively.

The axioms that govern R_Q are not straightforward and so we discuss them here. We base our axioms for R_Q on both the explicit and implicit discussion in SI.

First, we assume that R_Q is transitive. While SI claim their correspondence to be non-transitive, their constraints crucially refer to *correspondence chains*, or unbroken chains of corresponding elements. They state: “[A] sequence of three identical consecutive segments S in a grammar requiring that identical segments correspond would satisfy that constraint as follows: $S_1 S_{1,2} S_2$, where coindexation encodes correspondence” (SI, p. 5). In

other words, the first S_1 and third S_2 , although they do not directly correspond, satisfy any correspondence constraints because there is a correspondence chain connecting them (through the intermediary $S_{1,2}$). Thus, in practice, the correspondence relation of SI is transitive.

For ease of definition we further assume R_Q is also reflexive and symmetric and thus an equivalence relation (per Bennett (2015)).

$$EQ \stackrel{\text{def}}{=} \forall(x, y, z) [(xR_Q y \rightarrow yR_Q x) \wedge (xR_Q x) \wedge ((xR_Q y \wedge yR_Q z) \rightarrow xR_Q z)]$$

However, this choice is not crucial to our results.

Furthermore, like SI, we define R_Q to be local: “‘Local’ means consecutive; thus V-to-V correspondence is still considered local even if a consonant intervenes, as long as the closest two vowels in the string correspond” (SI: 4–5). In all of their case studies, correspondence is always between adjacent vowels. (The only candidate that includes non-local correspondence in terms of vowels is SI:(8d), which is not an optimum.) In the models here, consonants are not included, so vowels are strictly adjacent.

To restrict correspondence to a span of adjacent elements, we must adopt the following axiom.

$$ADJ \stackrel{\text{def}}{=} (\forall x, y, z) [(x < y \wedge y < z \wedge xR_Q z) \rightarrow (xR_Q y \wedge yR_Q z)]$$

ADJ states that for any x and z in correspondence, all intervening y must also be in correspondence. Note that this axiom requires specially adopting the $<$ relation, as it must hold for *all* intervening elements y . This is stricter than SI’s requirement of ‘consecutivity’, which instead restricts correspondence to intervening elements of some type—e.g., vowels—but as they are vague about how this is determined we ignore this here, and note only that relativizing ‘consecutivity’ to a particular type of element is also FO-definable (Graf, 2017).

Thus, we assume Q models satisfy $EQ \wedge ADJ$. (For comparison to models that do not, see §6.2.)

Finally, correspondence implies identity. As SI state: “Our operating assumption is that GEN does not even produce candidates in which elements obey CORR but violate the associated IDENT-XX constraint” (SI: 6). Thus, correspondence between two q s implies they are either both H or both L. Similarly, correspondence between Q s implies they are associated to identical strings of q s.

5 Transductions

We now show the FO-equivalence between these two representational theories by defining a transduction from \mathcal{Q} to \mathcal{A} , and then from \mathcal{A} to \mathcal{Q} .

5.1 From Q-Theory Representations

We begin with a transductions from QRs in \mathcal{Q} to ARs in \mathcal{A} . Intuitively, this transduction is based on the idea that a correspondence chain of qs in a QR is equivalent to a tone in an AR.

We identify qs by the fact that they carry tones.

$$q_{\mathcal{Q}}(x) \stackrel{\text{def}}{=} H_{\mathcal{Q}}(x) \vee L_{\mathcal{Q}}(y)$$

Then, to uniquely identify each chain of corresponding qs , we define the following predicate $\text{FC}(x)$, which identifies the *first correspondent*; i.e., the first element in a correspondence chain.

$$\text{FC}(x) \stackrel{\text{def}}{=} \neg(\exists y)[xR_{\mathcal{Q}}y \wedge y \triangleleft_{\mathcal{Q}} x]$$

This is possible with a successor relation $\triangleleft_{\mathcal{Q}}$ because of the adjacency axiom ADJ. If $y \triangleleft_{\mathcal{Q}} x$ and $\neg yR_{\mathcal{Q}}x$ and there is no z such that $z <_{\mathcal{Q}} x$ and $zR_{\mathcal{Q}}x$, then x must be first in the chain.

The transduction is thus as given in Table 1. The copy set is $C = \{1\}$, so we omit superscripts indicating copies. An example output structure, given Fig. 5 as an input, is given in Fig. 6.

$V_{\mathcal{A}}(x)$	$\stackrel{\text{def}}{=} Q_{\mathcal{Q}}(x)$
$H_{\mathcal{A}}(x)$	$\stackrel{\text{def}}{=} H_{\mathcal{Q}}(x) \wedge \text{FC}(x)$
$L_{\mathcal{A}}(x)$	$\stackrel{\text{def}}{=} L_{\mathcal{Q}}(x) \wedge \text{FC}(x)$
$x \triangleleft_{\mathcal{A}} y$	$\stackrel{\text{def}}{=} (Q_{\mathcal{Q}}(x) \wedge Q_{\mathcal{Q}}(y) \wedge x \triangleleft_{\mathcal{Q}} y) \vee$ $(q_{\mathcal{Q}}(x) \wedge q_{\mathcal{Q}}(y) \wedge \text{FC}(x) \wedge \text{FC}(y) \wedge$ $(\exists z)[xR_{\mathcal{Q}}z \wedge z \triangleleft_{\mathcal{Q}} y])$
$x A_{\mathcal{A}} y$	$\stackrel{\text{def}}{=} \text{FC}(x) \wedge (\exists z)[xR_{\mathcal{Q}}z \wedge z A_{\mathcal{Q}} y]$

Table 1: Transduction from \mathcal{Q} to \mathcal{A} .

First, the definitions of $V_{\mathcal{A}}(x)$, $H_{\mathcal{A}}(x)$, and $L_{\mathcal{A}}(x)$, are straightforward. As vowels in ARs and Qs in QRs are equivalent, we set $V_{\mathcal{A}}(x)$ equal to $Q_{\mathcal{Q}}(x)$. For $H_{\mathcal{A}}(x)$, and $L_{\mathcal{A}}(x)$, we set each to the first q of a chain that is valued either H or L, respectively. Thus, for example in Fig. 6, only nodes 1 and 5 are copied over from Fig. 5.

The definition of $x \triangleleft_{\mathcal{A}} y$, then, is relativized to elements for which these predicate are true. The

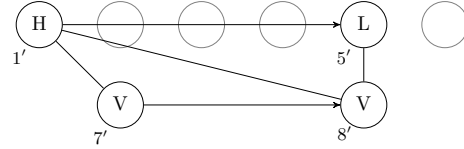

Figure 6: Output of the transduction in Table 1 given Fig. 5 as input; i' indicates a surviving copy of node i from Fig. 5.

disjunct $(Q_{\mathcal{Q}}(x) \wedge Q_{\mathcal{Q}}(y) \wedge x \triangleleft_{\mathcal{Q}} y)$ means that the successor relation between vowels in the AR is identical to the successor relation between Qs in the QR. The other disjunct defines the successor relation between tones. This has two parts: $q_{\mathcal{Q}}(x) \wedge q_{\mathcal{Q}}(y) \wedge \text{FC}(x) \wedge \text{FC}(y)$ ensures that the successor relation only holds between first elements in correspondence chains, and $(\exists z)[xR_{\mathcal{Q}}z \wedge z \triangleleft_{\mathcal{Q}} y]$ identifies for some x the element y that starts the next correspondence chain; that is, it succeeds the element z that is the last element in x 's correspondence chain. This can be seen in Fig. 6 between $1'$ and $5'$. In Fig. 5, in both 1 and 5 are first in their chains and 5 is the successor of 4, which corresponds with 1; thus $5'$ succeeds $1'$ in Fig. 6.

In a similar fashion, the definition for $x A_{\mathcal{A}} y$ holds true when x is the first member of a chain and y that is associated to some z that corresponds with x . Thus, for example, since 4 is associated to 8 in Fig. 5 and 4 is a member of 1's correspondence chain, $1'$ and $8'$ are associated in Fig. 6. Thus, \mathcal{A} is definable from \mathcal{Q} .

Lemma 2 \mathcal{A} is FO-definable from \mathcal{Q} .

Proof: Witnessed by transduction defined in Table 1. Note that these ARs will satisfy NG and NCC. Briefly, this is because $A_{\mathcal{A}}$ and $\triangleleft_{\mathcal{A}}$ are defined through $R_{\mathcal{Q}}$, which satisfies ADJ as outlined in Sec. 4.2. ADJ essentially orders correspondence chains, and thus the tones and association relations defined via $R_{\mathcal{Q}}$. \square

5.2 From Autosegmental Representations

For this transformation, the copy set is $C = \{0, 1, 2, 3\}$. For each vowel, we need both the vowel itself (for the Q ; let this be copy 0) and three copies (for each q ; let these be copies 1, 2, and 3).

The tones themselves in the AR are not copied. Instead, the values of the qs will be determined by the string of tones associated to the vowel in the

AR, as (partially) summarized in Table 2.²

Tones	qs	Tones	qs
H	$\rightarrow H_1H_{1,2}H_2$	L	$\rightarrow L_1L_{1,2}L_2$
HL	$\rightarrow H_1L_2L_2$	LH	$\rightarrow L_1H_2H_2$
HLH	$\rightarrow H_1L_2H_3$	LHL	$\rightarrow L_1H_2L_3$

Table 2: Mapping from strings of tones associated to a vowel (AR) to strings of qs associated to a Q (QR).

a. $\text{first}(x, y)$	$\stackrel{\text{def}}{=} \neg(\exists z)[xA_{\mathcal{A}}z \wedge z \triangleleft_{\mathcal{A}} y]$
b. $\text{last}(x, y)$	$\stackrel{\text{def}}{=} \neg(\exists z)[xA_{\mathcal{A}}z \wedge y \triangleleft_{\mathcal{A}} z]$
c. $\text{second}(x, y)$	$\stackrel{\text{def}}{=} (\exists z)[xA_{\mathcal{A}}z \wedge z \triangleleft_{\mathcal{A}} y \wedge \text{first}(x, z)]$
d. $\text{only}(x, y)$	$\stackrel{\text{def}}{=} \text{first}(x, y) \wedge \text{last}(x, y)$

Table 3: Predicates used in the AR to QR transduction

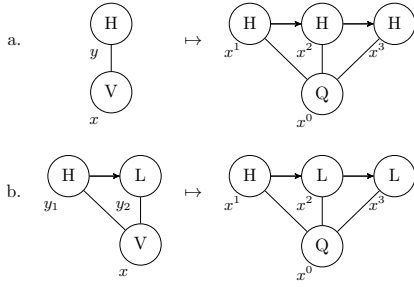

Figure 7: Deriving strings of qs from strings of tones. On the right, x^i indicates the i th copy of x .

These correspondences are FO-definable. First, we define a series of predicates $\text{first}(x, y)$, $\text{second}(x, y)$, $\text{last}(x, y)$, and $\text{only}(x, y)$ that indicate when y is the first, second, last, or only tone associated to x , respectively. These definitions are given in Table 3. (These do not explicitly associate y to x ; this will be invoked in later definitions.)

From these predicates we can determine, for each vowel in the AR, how to label its q copies in the QR. This is given in Table 4b. For example, $H_Q^1(x)$ is true when there is a H tone y that is the first tone associated to x . This means that copy 1 of x will be a q valued H. Similarly, $H_Q^2(x)$ is true when there is some H tone associated to x that is either the second tone or the *only* tone associated to x . This last disjunct is necessary in case x has a

²It is also the case that, e.g., a vowel associated to a string of three H tones (i.e., HHH) will be output as a Q associated to a string of three, non-corresponding H qs ($H_1H_2H_3$).

single H associated to it in the AR, for its equivalent QR all three qs will be H (see Fig. 7a).

Table 4a specifies when Qs are built: the 0th copy of each vowel x is labeled Q . Table 4c then specifies that the 0th copy of x is associated to each of its own copies 1, 2, and 3 (i.e., the qs). The specification that $x \approx y$ ensures that the Q for each vowel is associated to each of its q copies. Likewise, Table 4d specifies that the successor relation $\triangleleft_{\mathcal{A}}$ between vowels is preserved between Qs (i.e., the 0 copies of vowels) and, that for the 1st through 3rd copies of vowel x , its i th copy is succeeded by its own $i + 1$ th copy. The reader can confirm this via the examples in Fig. 7.

Finally, we define R_Q . First, as described in §4.2, correspondence between Qs is dependent on identity between Qs , which again depends on their associated qs . Thus, $xR_Q^{0,0}y$ should be true when the output Qs of x and y are associated to identical strings of qs . The values of q copies of are determined by the tones associated to x and y , respectively. Thus, Table 4e defines $xR_Q^{0,0}y$ with the predicate $\text{ident}(x, y)$, which is true if and only if the first, second, and last tones of x and y have the same value. (Let $\text{same}(x, y) \stackrel{\text{def}}{=} (H_{\mathcal{A}}(x) \wedge H_{\mathcal{A}}(y)) \vee (L_{\mathcal{A}}(x) \wedge L_{\mathcal{A}}(y))$.) For example, this is true of the vowels in Fig. 8a, but not in 8b.

Between qs , we define correspondence based on shared associations. Table 4f thus defines $xR_Q^{i,j}y$ for $1 \leq i, j \leq 3$ to be true when there is some z for which both x and y are associated. However, which qs of x and y correspond depend on z 's position relative to other tones associated to x and y . Thus, z must also satisfy requirements $\varphi_i(x, z)$ and $\varphi_j(y, z)$ based on the value of i and j .

For example, when $i = 1$ and $j = 1$ —that is, when defining correspondence between the 1st q of x and the 1st q of y — z must satisfy both $\text{first}(x, z)$ and $\text{first}(y, z)$. Intuitively, the first q of x and the first q of y correspond only if x and y share an association to z and z is the *first* tone associated to both x and y . This can be seen in Fig. 8; for example, in Fig. 8b, both x and y share an initial tone z , and so x^1 and y^1 correspond.

Thus, Table 4 is a transduction from \mathcal{A} to \mathcal{Q} .

Lemma 3 Q is FO-definable from \mathcal{A} .

Proof: Witnessed by the transduction defined in Table 4. In particular, we sketch why R_Q is guaranteed to be an equivalence relation over the copy set. First, $xR_Q^{i,i}y$ holds when $x \approx y$ and thus R_Q is

-
- a. $Q_{\mathcal{Q}}^i(x) \stackrel{\text{def}}{=} V_{\mathcal{A}}(x)$ for $i = 0$; **False** otherwise
- b. For $T \in \{H, L\}$, $T_{\mathcal{Q}}^0(x) \stackrel{\text{def}}{=} \text{False}$
- $$T_{\mathcal{Q}}^1(x) \stackrel{\text{def}}{=} (\exists y)[xA_{\mathcal{A}}y \wedge T_{\mathcal{A}}(y) \wedge \mathbf{first}(x, y)]$$
- $$T_{\mathcal{Q}}^2(x) \stackrel{\text{def}}{=} (\exists y)[xA_{\mathcal{A}}y \wedge T_{\mathcal{A}}(y) \wedge (\mathbf{only}(x, y) \vee \mathbf{second}(x, y))]$$
- $$T_{\mathcal{Q}}^3(x) \stackrel{\text{def}}{=} (\exists y)[xA_{\mathcal{A}}y \wedge T_{\mathcal{A}}(y) \wedge \mathbf{last}(x, y)]$$
- c. $xA_{\mathcal{Q}}^{i,j}y \stackrel{\text{def}}{=} x \approx y$ for $i = 0$ and $1 \leq i \leq 3$; **False** otherwise.
- d. $x \triangleleft_{\mathcal{Q}}^{i,j} y \stackrel{\text{def}}{=} x \triangleleft y$ for $i, j = 0$ or $i = 3, j = 1$; $x \approx y$ for $1 \leq i, j \leq 3, j = i + 1$; **False** otherwise.
- e. $xR_{\mathcal{Q}}^{0,0}y \stackrel{\text{def}}{=} \mathbf{ident}(x, y) \wedge (x \triangleleft_{\mathcal{Q}} y \vee y \triangleleft_{\mathcal{Q}} x)$, where
- $$\mathbf{ident}(x, y) \stackrel{\text{def}}{=} (\forall v, w) [((xA_{\mathcal{A}}v \wedge yA_{\mathcal{A}}w) \wedge ((\mathbf{first}(x, v) \wedge \mathbf{first}(y, w)) \vee ((\mathbf{only}(x, v) \vee \mathbf{second}(x, v) \wedge (\mathbf{only}(y, w) \vee \mathbf{second}(y, w))) \vee (\mathbf{last}(x, v) \wedge \mathbf{last}(y, w)))))) \rightarrow \mathbf{same}(v, w)];$$
- $$xR_{\mathcal{Q}}^{i,0}y \stackrel{\text{def}}{=} xR_{\mathcal{Q}}^{0,j}y \stackrel{\text{def}}{=} \text{False} \text{ for any } 1 \leq i, j \leq 3$$
- f. $xR_{\mathcal{Q}}^{i,j}y \stackrel{\text{def}}{=} (\exists z)[xA_{\mathcal{A}}z \wedge yA_{\mathcal{A}}z \wedge \varphi_i(x, z) \wedge \varphi_j(y, z)]$,
- where $\varphi_n(v, w) \stackrel{\text{def}}{=} \mathbf{first}(v, w)$ if $n = 1$,
 $(\mathbf{only}(v, w) \vee \mathbf{second}(v, w))$ if $n = 2$, and
 $\mathbf{last}(v, w)$ if $n = 3$, for $1 \leq i, j \leq 3$.
-

Table 4: Transduction from \mathcal{A} to \mathcal{Q}

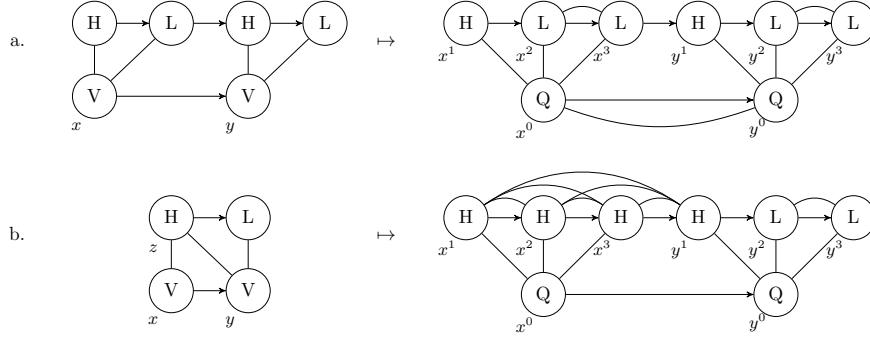

Figure 8: Deriving $R_{\mathcal{Q}}$ from tonal associations.

reflexive and symmetric. Finally, the fact that $R_{\mathcal{Q}}$ is transitive derives from the fact that the relation defined by $(\forall z)[xA_{\mathcal{A}}z \wedge yA_{\mathcal{A}}z]$ is transitive.

Also, because any input AR satisfies NG, x and y in an AR only share associations if they are adjacent, and thus $R_{\mathcal{Q}}$ will satisfy ADJ. \square

6 Summary and discussion

6.1 Equivalence of the models

We have now shown that \mathcal{A} is definable from \mathcal{Q} and \mathcal{Q} is definable from \mathcal{A} .

Theorem 1 \mathcal{A} and \mathcal{Q} are FO bi-interpretable.

Proof: From Lemmas 2 and 3. \square

As stated in the introduction, this means that for any FO constraint written for QRs, there is an equivalent FO constraint on ARs, and vice-versa. Thus, while QRs may be based on a particular set of axioms and constraints, an equivalent set of axioms and constraints can be written in ARs, without changing the complexity of the constraints.

Furthermore, while SI argue that QRs are a fundamental reimagining of phonological structure, our model-theoretic analysis shows that they are remarkably similar to ARs in which each vowel is associated to three autosegments. To illustrate this point, one reported benefit of QRs is that the

fixed number of 3 subsegments predicts contrasts between HHL and HLL-toned vowels, for instance (SI, p. 14). While not commonly proposed for ARs, this contrast is possible for ARs as well if the OCP is relaxed (as argued by Odden 1986).

6.2 Relation to other correspondence models

As noted in Sec. 4.2, we follow SI in restricting the correspondence relation to adjacent elements. This is more restrictive than other theories of correspondence; the formulation of Bennett (2013), for example, obeys EQ but not ADJ. How do ARs compare to QRs given a less restrictive correspondence relation? We conjecture that \mathcal{A} and \mathcal{Q} are incomparable to such a signature.

To see why, consider a signature identical to \mathcal{Q} with the exception that models in \mathcal{Q}' only satisfy EQ, thus allowing unbounded correspondence. Defining $R_{\mathcal{Q}}$ from R' would require defining a binary predicate in the FO logic of \mathcal{Q}' that satisfies ADJ. However, it is likely that no such predicate exists, because the definition of ADJ crucially requires $<$, and it is well-known that $<$ cannot be defined from \triangleleft . (See, e.g., Libkin (2004).)

Going the other way, \mathcal{Q}' essentially allows for quantification over a single abstract binary predicate whose only restriction is that it is an equivalence relation. For example, the FO language of \mathcal{Q}' includes sentences such as

$$(\forall x, y) [(\text{first}(x) \wedge \text{last}(y) \rightarrow xR'y) \wedge (\forall z, w) [w \triangleleft'_{\mathcal{Q}} x \wedge y \triangleleft'_{\mathcal{Q}} z \rightarrow wR'z]],$$

where $\text{first}(x) = (\forall y)[\neg y \triangleleft_{\mathcal{Q}} x]$ and $\text{last}(x) = (\forall y)[\neg x \triangleleft_{\mathcal{Q}} y]$. This enforces ‘center embedding’ correspondence where in a string of elements $a_0a_1a_2\dots a_{\ell-2}a_{\ell-1}a_{\ell}$, each a_i and $a_{\ell-i}$ (for $i \leq \ell/2$) are in correspondence.

Such a relation is almost certainly more expressive than anything definable in \mathcal{Q} and \mathcal{A} . First, \mathcal{A} is FO-definable from strings with $<$ (Jardine, 2017). FO-transductions are closed under composition (Courcelle et al., 2012). If \mathcal{Q}' were to be FO-definable from \mathcal{A} , it would then have to be FO-definable from strings. As ‘center embedding’-type relations are well-known to not be FO-definable, this is very likely not to be true.

6.3 Future work

An even stronger result would be that \mathcal{A} and \mathcal{Q} are equivalent under quantifier-free (QF) transductions (Chandlee and Lindell, forthcoming;

Strother-Garcia, 2017). However, QF transductions of Chandlee and Lindell and Strother-Garcia crucially use models with functions instead of pure relational models. Here, in order to hew to the standard definitions of association and correspondence as relations, we leave the interesting question of QF transductions for future work.

The result here is based on the machinery necessary to capture the case studies from SI, which all involve local tone interactions. As they also suggest extending their theory to segmental phonology, the obvious next direction is long-distance segmental phenomena. This involves more features, or unary predicates on qs , in addition to relaxing the ADJ axiom.

7 Conclusion

Model theory and logic provide for a powerful way to compare representational theories in phonology. Here, we have shown that ARs and QRs are not as different as they appear. This paper also serves as a case study for how logical transformations can be used to precisely evaluate theories of representation in phonology.

References

- William Bennett. 2013. *Dissimilation, Consonant Harmony, and Surface Correspondence*. Ph.D. thesis, Rutgers, the State University of New Jersey.
- William G. Bennett. 2015. *The phonology of consonants: Harmony, dissimilation, and correspondence*. Cambridge, UK: Cambridge University Press.
- Steven Bird. 1995. *Computational phonology: A constraint-based approach*. Studies in Natural Language Processing. Cambridge University Press.
- Jane Chandlee and Steven Lindell. forthcoming. A logical characterization of strictly local functions. In Jeffrey Heinz, editor, *Doing Computational Phonology*. OUP.
- Bruno Courcelle. 1994. Monadic second-order definable graph transductions: a survey. *Theoretical Computer Science*, 126:53–75.
- Bruno Courcelle, Joost Engelfriet, and Maurice Nivat. 2012. *Graph structure and monadic second-order logic: A language-theoretic approach*. Cambridge University Press.
- Gerrit Dimmendaal. 1988. Aspects du basaa. In *Bibliographie de la SELAF 96*. Paris, France: Peeters/SELAF. Trans. Luc Bouquiaux.
- Herbert Enderton. 1972. *A mathematical introduction to logic*. Academic Press.

- Joost Engelfriet and Hendrik Jan Hooeboom. 2001. MSO definable string transductions and two-way finite-state transducers. *ACM Transactions on Computational Logic*, 2:216–254.
- John Goldsmith. 1976. *Autosegmental Phonology*. Ph.D. thesis, Massachusetts Institute of Technology.
- Thomas Graf. 2017. The power of locality domains in phonology. *Phonology*, 34:385–405.
- Gunnar Ólafur Hansson. 2001. *Theoretical and Typological Issues in Consonant Harmony*. Ph.D. thesis, University of California, Berkeley.
- Wilfred Hodges. 1997. *A Shorter Model Theory*. Cambridge: Cambridge University Press.
- Larry Hyman. 2003. Basaa a.43. In Derek Nurse and Gérard Philippson, editors, *The Bantu Languages*, pages 257–282. London, UK: Routledge.
- Adam Jardine. 2017. On the logical complexity of autosegmental representations. In *Proceedings of the 15th Meeting on the Mathematics of Language*, pages 22–35, London, UK. Association for Computational Linguistics.
- Adam Jardine and Jeffrey Heinz. 2015. [A concatenation operation to derive autosegmental graphs](#). In *Proceedings of the 14th Meeting on the Mathematics of Language (MoL 2015)*, pages 139–151, Chicago, USA. Association for Computational Linguistics.
- Leonid Libkin. 2004. *Elements of Finite Model Theory*. Berlin: Springer-Verlag.
- Maire Ní Chiosáin and Jaye Padgett. 2001. Markedness, segment realization, and locality in spreading. In Linda Lombardi, editor, *Segmental phonology in Optimality Theory*, pages 118–156. Cambridge University Press.
- David Odden. 1986. On the role of the Obligatory Contour Principle in phonological theory. *Language*, 62(2):353–383.
- Christopher Potts and Geoffrey K. Pullum. 2002. Model theory and the content of OT constraints. *Phonology*, 19:361–393.
- James Rogers, Jeffrey Heinz, Margaret Fero, Jeremy Hurst, Dakotah Lambert, and Sean Wibel. 2013. Cognitive and sub-regular complexity. In *Formal Grammar*, volume 8036 of *Lecture Notes in Computer Science*, pages 90–108. Springer.
- Sharon Rose and Rachel Walker. 2004. A typology of consonant agreement as correspondence. *Language*, 80:475–531.
- Stephanie Shih and Sharon Inkelas. 2014. A subsegmental correspondence approach to contour tone (dis)harmony patterns. In *Proceedings of the 2013 Meeting on Phonology (UMass Amherst)*, Proceedings of the Annual Meetings on Phonology. LSA.
- Stephanie Shih and Sharon Inkelas. forthcoming. Autosegmental aims in surface optimizing phonology. Ms. available at [lingbuzz/002520](#).
- Kristina Strother-Garcia. 2017. Imdlawn Tashlhiyt Berber syllabification is quantifier-free. In *Proceedings of the first annual meeting of the Society for Computation in Linguistics*, volume 1, pages 145–153.
- Kristina Strother-Garcia and Jeffrey Heinz. 2017. Logical foundations of syllable representations. Poster presented at the 5th Annual Meeting on Phonology, New York University, New York City.
- Anssi Yli-Jyrä. 2013. On finite-state tonology with autosegmental representations. In *Proceedings of the 11th International Conference on Finite State Methods and Natural Language Processing*, pages 90–98. Association for Computational Linguistics.