

January 2007

# Biosynthesis of Arsenic by E. coli

Marissa K. Callahan

*University of Massachusetts Amherst*

Follow this and additional works at: <https://scholarworks.umass.edu/theses>

---

Callahan, Marissa K., "Biosynthesis of Arsenic by E. coli" (2007). *Masters Theses 1911 - February 2014*. 21.  
Retrieved from <https://scholarworks.umass.edu/theses/21>

This thesis is brought to you for free and open access by ScholarWorks@UMass Amherst. It has been accepted for inclusion in Masters Theses 1911 - February 2014 by an authorized administrator of ScholarWorks@UMass Amherst. For more information, please contact [scholarworks@library.umass.edu](mailto:scholarworks@library.umass.edu).

**BIOSYNTHESIS OF ARSENIC BY *E. coli***

A Thesis Presented

by

MARISSA KATHRYN CALLAHAN

Submitted to the Graduate School of the  
University of Massachusetts Amherst in partial fulfillment  
Of the requirements for the degree of

MASTER OF SCIENCE

May 2007

Chemistry

© Copyright by Marissa K. Callahan 2007

All Right Reserved

**BIOSYNTHESIS OF ARSENIC BY *E. coli***

A Thesis Presented

By

MARISSA K. CALLAHAN

Approved as to style and content by:

---

Julian F. Tyson, Chair

---

Richard W. Vachet, Member

---

Bret E. Jackson, Department Head,  
Department of Chemistry

## **DEDICATION**

To my family and friends

## ACKNOWLEDGEMENTS

I would like to express my sincere gratitude to my advisor, Professor Julian Tyson for believing in me, and for his guidance and assistance ever since I first joined the group as an undergraduate researcher. I would also like to thank my committee member, Professor Richard Vachet for his helpful comments and suggestions. I would also like to extend my thanks to Professor Klaus Nüsslein and his students for their advice and endless supply of *E. coli* and growth media.

I would like to thank Antoinette Otrando for her coaching advice, and believing in me throughout the past five years. I would like to extend my thanks to the UMass Athletic Scholarship for the financial support I received during my undergraduate and graduate studies.

I would like to thank Khalid Al-Assaf for getting me started, looking after me, and for all of the advice and guidance I received. I would like to extend my gratitude to the past and present members of the Tyson Group and everyone else in the Chemistry Department, especially Jum, Richmond, James, Elena, Princess, Fumin, Dan, P' A and Andrea for their caring friendship and assistance. I would also like to thank my classmates for an enjoyable and rewarding experience. I would like to extend my gratitude to the past and present members of the Thai Student Association for their friendship and assistance I received during the past two years.

Lastly, I would like to sincerely thank my family and friends for their love and support in everyway imaginable. I would like to thank my parents for their motivation and trusting me in my decisions.

## ABSTRACT

BIOSYNTHESIS OF ARSENIC BY *E. coli*

MAY 2007

MARISSA K CALLAHAN, B.S. UNIVERSITY OF MASSACHUSETTS AMHERST

B.S. UNIVERSITY OF MASSACHUSETTS AMHERST

M.S. UNIVERSITY OF MASSACHUSETTS AMHERST

Directed by: Professor Julian F. Tyson

A method was developed for pre-concentration, speciation and determination of arsenic species (As(III), As(V), MMA and DMA) in various water samples by solid phase extraction flow injection hydride generation atomic absorption spectrometry (SPE-FI-HG-AAS). The packing materials used for SPE included strong cation-exchange and strong anion-exchange silica beads. The devised method was successfully applied to the quantification of arsenic species in the University of Massachusetts campus pond water.

A new method was developed for the determination of methylation and reduction of arsenic species (As(III), As(V) and DMA) in Mueller-Hinton growth media by *E. coli* based on anion-exchange chromatography with post column hydride generation and inductively coupled plasma optical emission spectrometry (HPLC-HG-ICP-OES). The method was successfully applied to the determination of metabolism of arsenic by *E. coli* by analyzing the growth media and the cell extracts. The investigations suggested that *E. coli* did not methylate any of the arsenic species but simply reduced As(V) to As(III).

The media created a “split peak” effect for DMA, resulting in shorter retention time for the majority of the bulk and longer retention time for the rest of the species.

This effect is most likely due to the reaction of DMA with the protein present in the media, generating a positive complex, which resulted in the shifts in retention times.

Although the presence of hydride generation help enhances the arsenic signal by almost 30 times, it also affects the intensities of each arsenic species differently, some, such as As(III), benefit from the reaction than others, such as As(V). The studies revealed that when measuring different arsenic species in the absence of hydride generation, the ICP-OES sensitivity is not the same for all. Results from t- and F-tests suggested that AsB, DMA and As(V) are statistically the same, whereas As(III) and MMA, which are statistically indistinguishable, are from a different distribution.



## TABLE OF CONTENTS

	Page
ACKNOWLEDGEMENT .....	v
ABSTRACT .....	vi
LIST OF TABLES .....	x
LIST OF FIGURES.....	xi
CHAPTERS	
1. INTRODUCTION.....	1
1.1 Background .....	1
1.2 Speciation of Arsenic .....	4
1.2.1 Solid Phase Extraction .....	4
1.2.2 High Performance Liquid Chromatography.....	6
1.3 Research Objectives .....	7
1.4 References .....	12
2. DETERMINATION AND SPECIATION OF ARSNIC BY SOLID PHASE EXTRACTION AND FLOW INJECTION HYDRIDE-GENERATION ATOMIC ABSORPTION SPECTROMETRY (SPE-FI-HG-AAS).....	14
2.1 Introduction .....	14
2.2 Experimental .....	16
2.2.1 Instrumentation.....	16
2.2.2 Method Development.....	16
2.2.3 Part I. Speciation of Arsenic in Campus Pond Water .....	18
2.2.4 Part II. Speciation of Arsenic in Mueller-Hinton Broth.....	19
2.3 Results and Discussions .....	19
2.4 Conclusions .....	21
2.5 References .....	34
3. SPECIATION OF ARSENIC BY LIQUID CHROMATOGRAPHY – HYDRIDE GENERATION – INDUCTIVELY COUPLED PLASMA OPTICAL EMISSION SPECTROMETRY (HPLC-HG-ICP-OES).....	35
3.1 Introduction .....	35
3.2 Experimental .....	37

3.2.1	Instrumentation.....	37
3.2.2	Method Development.....	38
3.2.3	Speciation of Arsenic in Mueller-Hinton Broth.....	40
3.3	Results and Discussions .....	40
3.4	Conclusions .....	42
3.4.1	Intensities of Various Arsenic Species Measured with ICP-OES.....	42
3.4.2	Retention Time of DMA in MH Broth .....	43
3.4.3	Detoxification of Arsenic.....	43
3.5	References .....	65
4.	CONCLUSIONS AND FUTURE WORK .....	66
4.1	Conclusions.....	66
4.1.1	Solid Phase Extraction .....	66
4.1.2	High Performance Liquid Chromatography.....	67
4.1.3	Hydride Generation .....	68
4.1.4	Intensities of Various Arsenic Species.....	68
4.1.5	Biosynthesis of Arsenic by <i>E. coli</i> .....	69
4.2	Future Work .....	70
4.2.1	Generating Hydride Reactive Species.....	70
4.2.2	HPLC Columns .....	71
4.2.3	Growth Media .....	71
4.2.4	Different Models .....	72
4.3	References .....	73
	BIBLIOGRAPHY .....	74

## LIST OF TABLES

Tables	Pages
1.1 Structure and $pK_a$ of Common Arsenic Species.....	8
1.2 Percentages of Arsenic Species retained on Various SPE Cartridges.....	9
2.1 FI-HG-AAS Parameters .....	23
HPLC-MSIS-HG-ICP-OES Parameters.....	45
3.2 DMA in MH Media at Different pH .....	46
3.3 DMA at Different Concentrations of MH.....	47
Time Dependent Metabolism of As(V).....	48
3.5 Arsenic Uptake of <i>E. coli</i> at High Concentration.....	49

## LIST OF FIGURES

Figures	Pages
1.1 Arsenic geocycle according to Rosen .....	10
1.2 Simplified diagram of an arsenite transport system, where arsenate and phosphate enters the cell via the phosphate uptake system and adenosine triphosphate (ATP) is required to actively pump As(III) out of the cells ....	11
2.1 Layout of the FI manifold, with valve V1, in the load position (a), and injection position (b) .....	24
2.2 Less than 60% of As(III) eluted after being passed through the SCX and SAX columns (FT). The columns were then washed with 5 mL of deionized water (SCX and SAX water) followed by 5 mL of nitric acid (SCX and SAX nitric acid) to remove the residual As(III) from the columns. (Std refers to the sample before passing through the columns). Error bars are generated based on 95% confidence interval of the data .....	25
2.3 As(III) ran through both columns, followed by elution with 5 mL deionized water (FT), then with 5 mL 1 M HNO <sub>3</sub> (SCX and SAX nitric) to remove any residual As(III). FT is back calculated from the 1.5x deionized water dilution. (Std refers to the sample before passing through the columns) Error bars are generated based on 95% confidence interval of the data .....	26
2.4 Various flow rate of sample through the SCX and SAX column (controlled by peristaltic pumps) was optimized for application of pre-concentration. (Std refers to the sample before passing through the columns) Error bars are generated based on 95% confidence interval of the data .....	27
2.5 Arsenic (10 ppb) was speciated then quantified by SPE-HG-AAS. The investigations were conducted with a flow rate of 3 mL min <sup>-1</sup> and washing with nitric acid and acetic acid at 1 mL min <sup>-1</sup> . (Std refers to the sample before passing through the columns) Error bars are generated based on 95% confidence interval of the data .....	28
2.6 Accuracy of pre-concentration using SPE method was tested with 30 mL of deionized water spiked with 1 ppb of arsenic, eluting with 3 mL 1 M HNO <sub>3</sub> and then with 0.1 M CH <sub>3</sub> COOH. (Std refers to the sample before passing through the columns) Error bars are generated based on 95% confidence interval of the data.....	29

2.7	Different non-polar silica packing materials tested to find the material that retain the least amount of arsenic. From left to right, the materials tested included, hydrocarbons (C18 and C8), cyanopropyl (CN), phenyl (PH), and divinylbenzene (DVB). (Std refers to the sample before passing through the columns) Error bars are generated based on 95% confidence interval of the data .....	30
2.8	Deionized water, and arsenic-spiked deionized water samples speciated with SPE. The first 6 bars represent pre-concentrated samples, and the last 6 bars are back calculated to the original concentration revealing 0 and 1 ppb of arsenic in the original and spiked samples respectively. Error bars are generated based on 95% confidence interval of the data .....	31
2.9	Pond water was spiked with arsenic and quantified by HG-AAS. Recovery of 10 and 20 ppb of arsenic in campus pond water to study the effect of the matrix on the signal. Error bars are generated based on 95% confidence interval of the data.....	32
2.10	Pond water, and arsenic spiked pond water sample, speciated with SPE. The first six columns showed ten times pre-concentration of campus pond water. Back calculation revealed total of 0.67 ppb of arsenic (all three species). Error bars are generated based on 95% confidence interval of the data .....	33
3.1	Reaction scheme of TMAO, DMA and MMA formation from AsB suggested by Jenkins, et al. as an explanation to why AsB is not found in sea water .....	50
3.2	Schematic description for the biosynthesis of arsenobetaine from dimethylarsinoylribosides proposed by Jenkins, et al.....	51
3.3	Layout of the HPLC-HG-ICP-OES system, where V1 is the auto sampler injection valve, and the column used was an Alltech Anion R/10 $\mu\text{m}$ .....	52
3.4	Calibration functions for various arsenic species in water by ICP-OES. Without hydride generation, the intensities of the signal for all arsenic species should be the same. Based on t- and F-tests at 95% confidence, AsB, DMA and As(V) are statistically the same, and MMA and As(III) are statistically the same.....	53
3.5	Calibration for analysis of AsB (non-hydride reactive species) and DMA (hydride reactive species) in water with hydride generation by ICP-OES ..	54
3.6	Chromatograms of AsB (not hydride reactive) and DMA (hydride reactive) in water with hydride generation by ICP-OES.....	55

3.7	Chromatograms of DMA (1 ppm) in MH media at various pH values, between 7.39 and 2.39, to determine the best pH for a better resolution. The pH of the media is adjusted with nitric acid.....	56
3.8	Chromatograms of DMA (1 ppm) in MH media at various dilutions with water, ranging from 1 part MH, 0 part water (top) to 0 part MH and 1 part water.	57
3.9	Chromatograms of different concentrations of AsB, DMA, and As(V) in deionized water. ....	58
3.10	Chromatograms of (a) different concentration of AsB, DMA, and As(V) in MH media, and (b) of DMA and AsB; the DMA signal overlaps that of the AsB .....	59
3.11	Chromatograms of As(V) metabolism by <i>E. coli</i> over (a) a 2 hour time period, at 15 minutes intervals and (b) over a 48 hour time period at one-hour intervals for the first 6 hours .....	60
3.12	Chromatograms of As(III) extracted from different stages of the investigation. In (a), 1 ppm of As(III) in MH after 24 hours incubation without cells, as a control, then before analysis 0, 125 and 250 ppb of As(III) were added for standard addition analysis. Standard addition were also applied to (b) As(III) from MH after 24 hours incubation with cells, and (c) As(III) extracted from the cells using water and sonication overnight.....	61
3.13	Chromatograms of DMA extracted from different stages of the investigation. In (a), 1 ppm of DMA in MH after 24 hours incubation without cells, as a control, then before analysis 0, 125 and 250 ppb of DMA were added for standard addition analysis. Standard addition were also applied to (b) DMA from MH after 24 hours incubation with cells, and (c) DMA extracted from the cells using water and sonication overnight.....	62
3.14	Chromatograms of <i>E. coli</i> (a) grown in media contaminated with As(III) at concentrations ranging from 2.5 to 10 ppm and (b) then extracted with water and sonication overnight .....	63
3.15	Chromatograms of <i>E. coli</i> grown in media contaminated with DMA at concentrations ranging from 2.5 to 10 ppm, (a) MH media analysis and (b) extracted with water .....	64

# CHAPTER 1

## INTRODUCTION

### 1.1 Background

Arsenic is the 20<sup>th</sup> most abundant element in the earth's crust,<sup>1</sup> and is often associated with igneous and sedimentary rocks, especially sulfuric ores.<sup>2</sup> Arsenic concentrations in the earth crust, frequently averaged to be 3 mg L<sup>-1</sup> (3 ppm), range from the sub-ppb level to several hundred ppm, depending on the type of rock.<sup>2</sup> Although weather, biological, and volcanic activities are responsible for the redistribution of arsenic on the earth's surface and in the atmosphere, as illustrated in the arsenic geocycle shown in Figure 1.1,<sup>3</sup> more than half of the redistributions are caused by smelting operations, fossil-fuel combustions,<sup>2</sup> and other human activities, including wood preservation, application of insecticides, and distribution of feed additives.<sup>4</sup> In the U.S., roughly 90 percent of arsenic has been used in wood preservation processes, although pressure treated wood is no longer used for residential purposes.<sup>5,6</sup> Other uses of arsenic include paints and dyes, metals, drugs, soaps, and semi-conductors.<sup>5</sup>

The most common form of inorganic arsenic found in aerobic environments is arsenate (As(V)) in the form of H<sub>2</sub>AsO<sub>4</sub><sup>-</sup> and HAsO<sub>4</sub><sup>2-</sup>.<sup>1</sup> In anaerobic environments, arsenite (As(III)), on the other hand, is more prevalent in the form of H<sub>3</sub>AsO<sub>3</sub> and H<sub>2</sub>AsO<sub>3</sub><sup>-</sup>.<sup>1</sup> Many organic arsenic compounds, such as methylarsonic, methylarsonous and dimethylarsinic acids, can be found as excreted products from microbes and animals, including humans.<sup>1,2</sup> "Naturally occurring" sources of arsenic can be found in many surface drinking water aquifers around the world,<sup>1</sup> most of which are from mountain

runoffs, such as the Himalayas in Bangladesh. Some of the known sources of contamination include pressure-treated wood, runoff from mine tailings, pigment production for paints and dyes, coal combustion, and application of pesticides.<sup>1</sup> Between 1930 and 1980, ten thousand metric tons of arsenic were accumulated from pesticide alone.<sup>4</sup> Some rare cases of contamination include production and storage of chemical weapons.<sup>1</sup> Most of the sources of arsenic contamination have been replaced, but some applications still requires the use of arsenic, such as in agriculture. Roxarsone (4-hydroxy-3-mitrophenyl arsonic acid) is still used as an “intestinal palliative in swine to prevent coccidiosis (parasitic infection in the intestine), improve pigmentation, and increase growth in feedlot-raised poultry”.<sup>1,5</sup> Annually between 20 and 50 metric tons of roxarsone is used on the east coast of the United States.<sup>6</sup> Because arsenic is not accumulated in the tissues or the eggs of chicken, the manure excreted contains over 20 mg/kg arsenic.<sup>7</sup>

The toxicity of arsenic has been known for centuries, resulting in arsenic being one of the most popular chemicals used in homicides until the mid-19<sup>th</sup> century when James Marsh devised a method of detecting arsenic in tissues.<sup>1</sup> Although arsenic is known to be very toxic to humans, many medical communities have been using it as chemotherapy for some leukemia patients.<sup>8</sup>

The toxicity of arsenic depends on its chemical form. Arsenite is the most toxic form of arsenic, binding to sulfhydryl groups, such as in cysteine, interfering with many proteins functions, and binding to thiols in pyruvate dehydrogenase and 2-oxo-glutarate dehydrogenase, interfering with respiration.<sup>9</sup> A few years ago, Kaltreider et al.<sup>10</sup> discovered that arsenite also binds to glucocorticoid receptors, which bind to cortisol, and



some other steroids (glucocorticoids) to regulate cellular activities. Arsenate, similarly also inhibits cellular process by interfering with respiration. Because of the similarity to phosphate, sometimes arsenate is mistaken for phosphate, which is how it is introduced into living organisms, including *E. coli*, by the phosphate uptake system. Other molecules such as As(III) can also be introduced into the cells by various membrane transporter.<sup>11</sup> Arsenate interferes with the production of ATP (energy source in living organisms) during glycolysis. If the phosphodiester bond, which “stores” a large amount of energy, is not formed, then cellular respiration is disrupted.<sup>12</sup>

Different organisms have evolved and developed different ways to detoxify and remove the arsenic present in the cells, such as reduction and methylation and specific transporters. Two types of methylated arsenic species, monomethylarsonic acid (MMA) and dimethylarsinic acid (DMA), are formed by the reduction of As(V) to As(III) by glutathione. *S*-adenosylmethionine then donates methyl groups to As(III) forming the methylated species above. Arsenobetaine (AsB) is non-toxic and is believed to be the final form of methylated arsenic species in the marine environment.<sup>13</sup>

In general, metal-accumulating microorganisms also tend to be metal-resistant microorganisms.<sup>14</sup> Arsenic is toxic to many bacteria; however, some are more resistance to arsenic than others. Microorganisms have evolved a number of resistance strategies towards arsenic, including (a) membrane transport systems that actively pump arsenite out of the cells, as can be seen in the simplified diagram shown in Figure 1.2, and (b) the presence of a transport system that is strictly phosphate-specific, preventing uptake of arsenate into the cells.<sup>14</sup> Several strains of bacteria have been engineered to increase their resistant to arsenic in order to study hyper-accumulation with microorganisms.<sup>14</sup> Other

species such as *Vibrio fischeri*, a light emitting bacteria, could be used as an indicator for arsenic contamination. In the presence of the toxins, the luminescence will be decreased.<sup>15</sup>

## 1.2 Speciation of Arsenic

Depending on the pH of the solution As(III), As(V), MMA, DMA and AsB, which have  $pK_a$  values of 9.3, 2.3, 2.6, 6.2, and 2.2 respectively, as illustrated in Table 1.1, are either cationic, anionic or uncharged,<sup>16</sup> allowing for different speciation methods such as anion-exchange, ion-pairing and cation-exchange chromatographies. Anion-exchange HPLC yielded good resolution with pH between 5 and 11 for speciation of As(III), As(V), MMA, DMA and AsB.<sup>16</sup> Cation-exchange HPLC is preferred for analyzing samples containing arsenocholine (AC), tetramethylarsonium (TeMA), and trimethylarsine oxide (TMAO) either by themselves or as a mixture, for which the pH needs to be lower than 4.<sup>16</sup>

Cai et al.<sup>16</sup> studied various extraction columns and eluents for optimal yield while maintaining the flow rate of the solution at  $1.0 \text{ mL min}^{-1}$ . The solvent used in the extractions differed from one sample to the next. These eluents included acetic acid, methanol, and nitric acid, and the columns used are listed in Table 1.2. Some biological samples of arsenic exist as lipid-soluble compounds and therefore the extractant must also be lipid-soluble, which affects the efficiency of the extractant. Thomaidis et al.<sup>17</sup> investigated with few extractants initially, and they used different mixtures of methanol and deionized water or just deionized water alone.

### 1.2.1 Solid Phase Extraction

Speciation methods include solid-phase extraction (SPE) with strong cation- and anion-exchange columns or with electrophoresis. Other packing materials commonly utilized include hydrocarbons, mixed-mode, and various non-polar silica beads. SPE is also used for pre-concentration of certain species of arsenic that could be retained in the columns.

A comprehensive study was made by Cai et al.<sup>16</sup> At pH 5.6, the various species of arsenic have with different charges, and the percentage of arsenic retained in the columns is higher for most species studied, compared with pH 2, 3.5 and 9. Arsenocholine and TeMA are cationic and can be retained in cyanopropyl (CN), ethylbenzene sulfonic acid (SCX-3), propylcarboxylic acid (CBA), and mixed-mode (M-M, containing C18,  $-\text{SO}_3^-$  and  $-\text{NR}_3^+$ ) cartridges.<sup>16</sup> In addition, AC was also retained on primary secondary amine (PSA) cartridges. Arsenate and MMA which are anionic species, and were fully retained on the strong anion-exchange column (SAX, also known as quaternary amine) and hydrophobic and anion-exchange column (HAX, composed of C8 and  $-\text{NR}_3^+$ ) cartridges containing SAX sorbent and also the M-M cartridge.<sup>16</sup> In addition, As(V) has very strong acidity relative to MMA, and therefore it was completely retained on PSA and aminopropyl ( $\text{NH}_2$ ) cartridges, which are weaker anion-exchange columns.<sup>16</sup> Arsenobetaine is a zwitterion and was completely retained on both the SCX-3 and M-M columns.<sup>16</sup> As(III), DMA, and TMAO have no charge at pH 5.6. SCX-3 was the only column that retained DMA strongly.<sup>16</sup> SAX, HAX, PSA and M-M partially retained DMA. Similarly, As(III) was partially retained on the PSA and  $\text{NH}_2$  cartridges and nothing else.<sup>15</sup> Trimethylarsine oxide was completely retained on the  $\text{NH}_2$ , SCX-3, CBA, and M-M cartridges.<sup>16</sup> Cai et al.<sup>16</sup> showed that at pH 5.6, the use of various

packing materials for solid phase extraction can speciate most arsenic species, some have better affinity for one species more than others. The studies performed (described later in section 2.2) were based on the results obtained by Cai et al.,<sup>16</sup> which are summarized in Table 1.2.

### 1.2.2 High Performance Liquid Chromatography

Similar to SPE, the different dissociation constants of each arsenic species will allow them to be separated with high performance liquid chromatography (HPLC) using an ion-exchange column. Although SPE is an inexpensive and simple method of speciation, matrix effects can result in irreproducible results. Preliminary studies demonstrated that the matrix effect of Mueller-Hinton (MH) broth growth medium, widely used to maintain cell cultures, interfered with the SPE speciation method, whereas HPLC, on the other hand was not affected by the broth. This is further discussed in Chapter 3. Based on previous studies conducted by Al-Assaf,<sup>18</sup> at pH 5.6, As(III) was not retained in the anion-exchange column and was eluted with the solvent front. Arsenobetaine was not retained in the column either and would have eluted with As(III). Slightly more negative DMA is next to elute, followed by MMA and As(V), the most negative species studied.<sup>18</sup>

Although numerous studies have been conducted regarding biological detoxification processes of arsenic, the exact pathways are still unknown because observation of step-wise cellular activities is extremely difficult. However, a few new species of arsenic (M-1, M-2 and M-3) have been discovered<sup>19</sup> in the process, although very little is known about the species. There are only a few studies in which the biologically mediated transformations of arsenic by *E. coli* have been investigated, and

although there are numerous reports of the speciation of arsenic by HPLC coupled to atomic spectrometry detectors, there are no methods reported for the determination of arsenic species in the growth media commonly used.

### **1.3 Research Objectives**

The goal of this study was to devise a method of speciating and quantifying various species of arsenic with SPE and HPLC. Along with separation, SPE was also used for pre-concentration of samples with low arsenic concentrations. The SPE method developed for speciation and pre-concentration of arsenic in deionized water was applied to the analysis of University of Massachusetts' Campus Pond water, which models natural bodies of water. Because the interference of MH media on SPE, an HPLC method developed by Al-Assaf<sup>14</sup> was applied to the speciation of arsenic in *E. coli*, and their environment, in order to determine the effect of arsenic on the bioactivity of the bacteria.

According to the literature, living organisms, including *E. coli*, are known to methylate and reduce arsenic species as means of detoxification. The study was designed to investigate the rate and amount at which *E. coli* can metabolize various species of arsenic and to detect by speciation with anion-exchange chromatography with hydride generation coupled to ICP-OES, any arsenic species synthesized.

**Table 1.1:** Structure and  $pK_a$  of Common Arsenic Species<sup>13</sup>

Name	Chemical Formula	$pK_a$	Chemical Structure
<b>Arsenite</b> [As(III)] Arsenous acid	$As(OH)_3$	9.2	
<b>Arsenate</b> [As(V)] Arsenic acid	$As(OH)_3O$	2.3 6.8 11.6	
<b>Monomethylarsonic acid</b> [MMA]	$As(CH_3)(OH)_2O$	3.6 8.2	
<b>Dimethylarsinic acid</b> [DMA]	$As(CH_3)_2(OH)O$	6.2	
<b>Trimethylarsine oxide</b> [TMAO]	$As(CH_3)_3O$	4	
<b>Tetramethylarsonium ion</b> [TeMA]	$As(CH_3)_4$	Not Available	
<b>Arsenobetain</b> [AsB]	$As(CH_3)_3CH_2COO^-$	2.18	
<b>Arsenocholine</b> [Ac]	$As(CH_3)_3(CH_2)_2OH$	Not Available	

**Table 1.2:** Percentages of Arsenic Species Retained on Various SPE Cartridges<sup>13</sup>

Cartridge type	As(III)	As(V)	DMA	MMA	AsB	AsC	TMAI	TMAO
C18	0	0	0	0	0	56±6	38±3	80±4
C8	0	0	0	0	0	73±5	48±4	77±5
DIOL	0	6±3	0	18±4	0	12±4	21±6	41±7
SAX	0	100±3	41±5	100±2	6.5±3	0	0	0
HAX	0	100±5	46±5	100±6	0	0	0	0
PSA	48±7	100±6	19±4	72±8	18±5	100±5	0	11±4
NH2	23±5	100±4	0	28±2	23±6	100±3	0	100±3
SCX-3	0	0	100±3	0	100±4	95±4	100±4	100±6
CBA	0	0	0	14±5	17±6	100±3	96±3	100±5
CN	0	0	0	24±7	34±5	100±3	94±3	21±8
M-M	0	94±4	38±7	93±5	100±4	100±2	100±6	100±3

pH 5.6, 10 mL of 2 ppb As(III), As(V), MMA, DMA, AsB, AsC, TMAI, and TMAO,<sup>11</sup> where DIOL is 2,3-dihydroxypropoxypropyl.

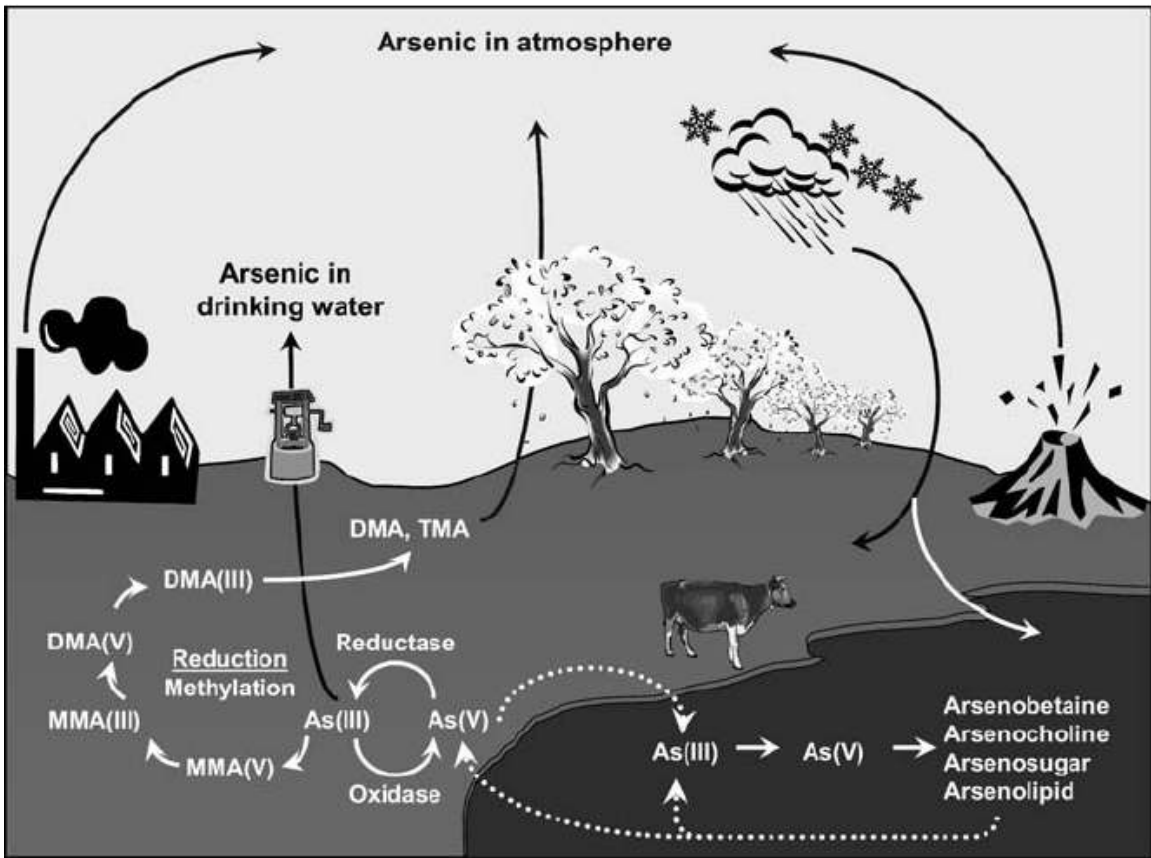
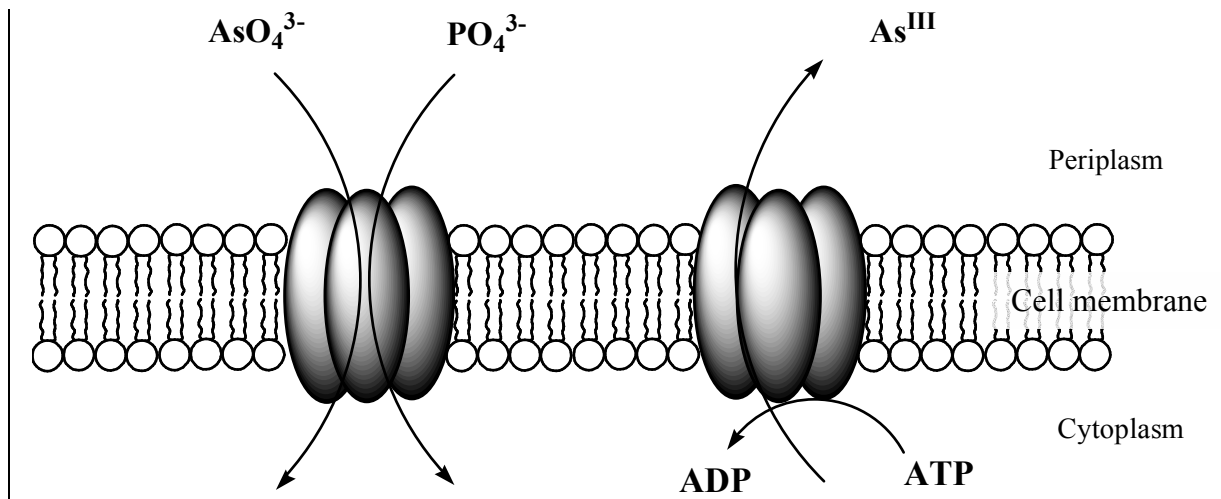


Figure 1.1: Arsenic geocycle according to Rosen.<sup>3</sup>





**Figure 1.2:** Simplified diagram of an arsenite transport system, where arsenate and phosphate enters the cell via the phosphate uptake system and adenosine triphosphate (ATP) is required to actively pump As(III) out of the cells.

#### 1.4 References

- (1) National Research Council. *Arsenic*; National Academy of Sciences: Washington, DC, **1977**, 16.
- (2) Cullen, W., and Reimer, K. *Chem. Rev.* **1989**, *89*, 713-764.
- (3) Bhattacharjee, H., and Rosen, B. *Microbiol Monogr.* **2007**,
- (4) Mandal, B., and Suzuki, K. *Talanta.* **2002**, *508*, 201-235.
- (5) Office of Ground Water and Drinking Water (OGWDW). *U.S. Environmental Protection Agency.* Washington, D.C. 2006.
- (6) Agency for Toxic Substances and Disease Registry (ATSDR). *U.S. Department of Public Health and Human Services, Public Health Service.* Georgia, 2005.
- (7) Oremland, R., and Stolz, J. *Science.* **2003**, *300*, 939-944.
- (8) Czarnecki, D., and Baker, G. *Poultry Sci.* **1982**, *61*, 516.
- (9) Petrick, J., Ayala-Fierro, F., Cullen, W., Carter, D., and Aposhian, HV. *Toxicol. Appl. Pharmacol.* **2000**, *163*, 203-207
- (10) Kaltreider, R., Davis, A., Lariviere, J., and Hamilton, J. *Environ. Health Perspect.* **2001**, *109*, 245-251.
- (11) Rosen, B. Metals in Biology: Past, Present and Future. *Molecular Biology of Metal Homeostasis and Detoxification: From Microbes to Man*, 1<sup>st</sup> edition; Topics in Current Genetics; Springer: Berlin, 2006; 14, 485-505.
- (12) Christen, K. *Environ Sci. Technol.* **2001**, *35*, 184A.
- (13) Takeuchi, M., Kawahata, H., Gupta, L.P., Kita, N., Morishita, Y., Ono, Y., Komai, T. *J. Biotechnol.* **2007**, *127*, 434-442.
- (14) Fulladosa, E., Murat, JC., Bollinger, JC., Villaescusa, I. *Sci. Total Environ.* **2007**, *Article in Press.*
- (15) Wrobel, K., Wrobel, K., Sasi, P., Kannamkumarath, S., and Caruso, J. *Talanta* **2002**, *58*, 899-907.
- (16) Cai, Q., Yu, C., Guo, Z., Yang, Z., Khoo, S.B. *Spectrochim. Acta Part B.* **2003**, *58*, 1335-1349.

- (17) Thomaidis, N., Schaeffer, R., Soeroes, C., Ipolyi, I., Fodor, P. *Anal. Chim. Acta.* **2005**, *547*, 109-118
- (18) Al-Assaf, K.H. Determination of Arsenic Species in Environmental Samples. Doctor of Philosophy Dissertation, University of Massachusetts, Amherst, MA, February 2007.
- (19) Jenkins, R., Ritchie, A., Edmonds, J., Goessler, W., Molenat, N., Kuehnelt, D., Harrington, C., Sutton, P. *Arch. Microbiol.* **2003**, *180*, 142-150.
- (20) Pott, W., Benjamin, S., and Yang, R. *Rev. Environ. Contam. Toxicol.* **2001**, *169*, 165.
- (21) National Research Council. *Arsenic in Drinking Water*. National Academy Press, Washington, D.C. **1999**.
- (22) Alberts, B., Johnson, A., Lewis, J., Raff, M., Roberts, K., and Walter, P. *Molecular Biology of the Cell*. Fourth Edition. Garland Science, New York, NY. 2002
- (23) Leermakers, M., Baeyens, W., De Gieter, M., Smedts, B., Meert, C., De Bisschop, H.C., Morabito, R., Quevauviller, Ph. *Trends in Anal. Chem.* **2005**, *25*, 1-10.
- (24) Morrison, J. *J. Ag. Food Chem.* **1969**, *39*, 146.
- (25) Welch, A., Westjohn, D., Helsel, S., and Wanty, R. *Groundwater*. **2000**, *13*, 589.

## CHAPTER 2

### DETERMINATION AND SPECIATION OF ARSENIC BY SOLID PHASE EXTRACTION AND FLOW INJECTION HYDRIDE-GENERATION ATOMIC ABSORPTION SPECTROMETRY (SPE-FI-HGAAS)

#### 2.1 Introduction

Arsenic contamination in the environment is a major health concern around the world, especially the contamination of drinking water.<sup>1</sup> Consumption of arsenic can lead to problems such as conjunctivitis, cardiovascular diseases, gangrene and cancer, including skin, bladder and lung cancer.<sup>2</sup> Since 1984, the World Health Organization (WHO) has assigned a limit at 0.05 mg L<sup>-1</sup> of arsenic in drinking water because of its toxicity.<sup>1,3</sup> This was revised downward in the 1993 Guidelines for Drinking-water Quality to a provisional value of 0.010 mg L<sup>-1</sup> which has been reiterated in the 2003 Background Document for Development of WHO Guidelines for Drinking-water Quality. One of the major areas of concern for its high level of contamination is in South and Southeast Asia, especially in Bangladesh and India, where the average concentration in ground water is about 300 ppb, about thirty times higher than the guideline level of the WHO. Arsenic in well water is often tested with a field test kit, which is an unreliable method of measurement because of the semi-quantitative characteristic, especially at low concentrations.<sup>4</sup>

Arsenic and phosphorus are very similar chemically. Arsenate behaves like phosphate, one of the fundamental nutrients in the plant-soil system.<sup>5</sup> The higher the

concentration of arsenic in the soil, the more arsenic will accumulate in the plant. Some plants can absorb higher concentrations of arsenic than others in the same soil.<sup>6</sup>

It is known that the toxicity of arsenic depends on its chemical form. Inorganic arsenic (arsenate and arsenite) is at least 100 times more toxic than organic forms, such as monomethylarsonic (MMA) and dimethylarsinic acid (DMA), which may be formed by bacterial methylation in soil, and more complex forms of arsenic such as arsenobetaine (AsB) are considered non-toxic, while the toxicities of arsenocholine (AC) and arsenosugars are still unknown.<sup>4</sup> Each of these forms also have different  $pK_a$  values, which are shown in Table 1.1.

The University of Massachusetts campus pond is a man-made pond containing fishes and also home to mallard ducks, Canadian geese, and swans. Because of the location, size, elevation and lack of circulation of the pond, the possibility of arsenic runoff from the surrounding area is high. This investigation, whose results are discussed in this chapter, focused on speciation and quantification of arsenic in campus pond water with SPE coupled to HG-AAS.

Studies were conducted with Mueller-Hinton (MH) broth in order to investigate metabolism of arsenic by *Escherichia coli* (*E. coli*) with the method developed. *E. coli* can be found naturally in intestines of animals including humans, but in laboratory settings, several growth media have been used to maintain *E. coli* cultures, where two of the most common media used are MH and Luria-Bertani (LB) broth. The developed SPE method was applied to determine the concentrations of various arsenic species metabolized by *E. coli* in the broth.

## **2.2 Experimental**

### **2.2.1 Instrumentation**

This investigation was conducted with a Perkin Elmer 1100B, double beam atomic absorption spectrometer with deuterium background correction (Perkin Elmer Instruments, Shelton, CT, USA). The arsenic electrode discharge lamp (EDL) was powered by a Perkin Elmer system 2 EDL and operated at 300 mA. An air-acetylene flame heated the 16-cm, 8-mm id quartz tube atomizer. The analysis wavelength and spectral band pass selected were 193.7 nm and 0.7 nm, respectively.

For this study, 0.2 M HCl, at 5 mL min<sup>-1</sup>, carried the sample, which was injected into a 200- $\mu$ L sample loop, into the 2-meter reaction coil, where the sample was then reacted with 1.5% sodium borohydride solution, at flow rate of 1.5 mL min<sup>-1</sup>. The reaction forms arsine gas (AsH<sub>3</sub>) and liquid waste, which is separated in the gas liquid separator. The argon gas is then used to carry the arsine gas up in to the quartz tube to be analyzed by atomic absorption spectrometry while the liquid goes to waste. The manifold layout for the load position is displayed in Fig 2.1a and the inject position in Fig 2.1b.

### **2.2.2 Method Development**

The method applied to the speciation of arsenic was developed by Yu *et al.*<sup>8</sup> in order to speciate and pre-concentrate DMA, MMA and As(V). The pre-packed, disposable, strong cation- and strong anion-exchange silica columns (Amberlite IRA-400, DSC-SCX and DSC-SAX respectively, Sigma-Aldrich Co., USA) were conditioned with 1:1 ratio of water and methanol, followed by a water wash, a 1 M nitric acid wash to strip

the columns of unwanted residuals, and a water wash to remove the excess nitric acid and prepare the columns for the studies. As(III), As(V), AsB, MMA and DMA were diluted from a stock solution with deionized water to a concentration of 10 ppb of arsenic each to create a mixed sample. After adjusting the pH with HNO<sub>3</sub> and NH<sub>4</sub>OH to about 5.6, the samples were run through SCX then SAX columns, which were connected in series at an optimum flow rate of 3 mL min<sup>-1</sup>. The effluent contained As(III); 5 mL of deionized water was used to wash the column to remove any As(III) that remained. The SCX column was washed with 1 M HNO<sub>3</sub> in order to collect DMA and AsB, 0.1 M CH<sub>3</sub>COOH and 1 M HNO<sub>3</sub> eluted the SAX column for MMA and As(V), respectively.

As previously discussed, different species of arsenic have different pK<sub>a</sub> values, shown in Table 1.1, allowing them to be retained in various ion-exchange columns. Five species of arsenic were studied: arsenite (As(III)), arsenate (As(V)), arsenobetaine (AsB), MMA and DMA. Arsenite has a pK<sub>a</sub> of 9.2 and would not be retained in any of the columns used. MMA and As(V) will be retained in the SAX column at pH 5.6 and could be eluted with acetic acid and nitric acid, respectively. DMA, although its behavior is not well understood, will be retained by SCX column between pH 4 and 8 and could be eluted with nitric acid.

At the optimum pH of 5.6, As(III) is neutral and would not have any attraction to either the SCX column or the SAX column. Arsenobetaine and DMA, on the other hand, would bind to the negative silica column (SCX). MMA and As(V) will both have negative charge and therefore will bind to the positive silica column (SAX). Since both DMA and AsB could be retained in the SCX column, SPE is not the best mean of speciating arsenic in samples containing mixtures of AsB and DMA.

Along with flow rate of the samples, various types of non-polar column packing materials were also tested to interact and trap organic compounds found in the pond water that could potentially interfere with the reading. The columns investigated included C18, C8, cyanopropyl (CN), phenyl (Ph), and divinylbenzene (DVB) columns. Two 5 mL samples for each of the four species of arsenic were created at 10 ppb concentration. One of the samples was passed through the columns while the other was used as a standard.

### **2.2.3 Part I. Speciation of Arsenic in Campus Pond Water**

The same method was applied to the campus pond water sample but the concentration of arsenic was not high enough to be detected by the AAS, so a spike recovery method and pre-concentration were used. The campus pond water (60 mL) was filtered using gravitational filtration to remove soil, sediment and other large particles from the water and then pre-concentrated 10 times on both the SCX and SAX columns by eluting with 6 mL of acids. Because As(III) could not be retained on SCX and SAX columns at pH of 5.6, it was excluded from the pre-concentration experiments. A second method used to determine the arsenic concentration in the pond water is the recovery method, where the filtered pond water was spiked with high concentration of arsenic. The excess arsenic presence is considered to be the amount present in the pond. This method was first tested on deionized water. Once reproducible results were obtained, other matrices such as pond water and Mueller-Hinton broth were tested.

For the spike recover method, the Campus pond water was spiked with 10 and 20 ppb of arsenic. The spiked samples along with the original samples were passed through the column at 3 mL min<sup>-1</sup> and quantified with atomic absorption spectrometry. For the pre-concentration method, 30 mL sample was spiked with 1 ppb concentration of arsenic.



After the sample ran through the column, 3 mL of acid was used to elute the columns. This experiment was then repeated using filtered campus pond water. Pond water was pre-concentrated ten times down to 6 mL.

#### **2.2.4 Part II. Speciation of Arsenic in Mueller-Hinton Broth**

Mueller-Hinton (MH) broth, composed of meat infusion, casein hydrolysate, and starch, was prepared from dehydrated powder with double distilled water and then was autoclaved. The sterile broth was stable at 4 °C for up to two weeks. The arsenic was added to the broth in the same manner as deionized water. The arsenic contaminated broth was then pumped through the SCX and SAX columns at 3 mL min<sup>-1</sup>, washed and eluted with 5 mL of deionized water, and nitric acid or acetic acid, as noted above, then quantified with HG-FI-AAS, using the parameters shown in Table 2.1.

### **2.3 Results and Discussion**

The yield of As(III) (labeled as FT in Figure 2.2) was lower than what was expected, so to determine whether As(III) was retained in the columns physically (in the solution in the interstices) or chemically (bound to the surface functional groups), the columns were washed: first with deionized water, then with 1 M nitric acid. The residual As(III) was eluted from the columns when the columns were washed with deionized water, as shown in Figure 2.2. This suggests that As(III) was retained in the column physically and not chemically bound to the solid phase. Because As(III) was only physically retained, acid was not required and deionized water was enough to remove residual arsenic from the columns. The sum of the arsenic concentration in the eluent (FT) and the deionized water and nitric acid washes from the two columns was to about

10 ppb for both trials (S1 and S2), which was about 100% recovery. After reproducible results were obtained, the method was applied to later experiments with slight modification. Deionized water (5 mL) was used to elute remaining arsenic from the columns after an arsenic-contaminated sample was passed through both columns, resulting in dilution factor of 1.5 times with close to 100% recovery, as can be seen in Figure 2.3. The contaminated samples were passed through the SCX and SAX columns, followed by 5 mL of deionized water (FT), then 5 mL of 1 M HNO<sub>3</sub>. Less than 0.5 ppb and about 1 ppb of As(III) were retained in the SCX and SAX columns, respectively, after the columns were eluted with water (Figure 2.3).

Different flow rates of sample passing through the two columns were investigated to determine the fastest flow rate that could be used without loss of retention efficiency. Although the sample flow rate was varied (1, 2, 3 and 6 mL min<sup>-1</sup>), the elution rate with nitric and acetic acid remained the same at 1 mL min<sup>-1</sup>. The results are shown in Figure 2.4. The fastest flow rate yielding the most consistent results was determined to be 3 mL min<sup>-1</sup>. The results for two experiments are, presented in Figure 2.5. Although the first trial (S1) yielded concentrations up to 8 ppb higher than the actual concentration of 10 ppb, the second (S2) and subsequent trials yielded reproducible results much closer to the values of the standards. The pre-concentration procedure was performed with 30 mL of deionized water spiked with 1 ppb of arsenic. The SCX and SAX columns were then washed with 3 mL HNO<sub>3</sub> and acetic acid, respectively, resulting in pre-concentration factor of 10, as can be seen in Figure 2.6. Deionized water was spiked with 1 ppb of As(V), MMA, DMA, and compared to the uncontaminated sample (no arsenic added). When back calculated from the pre-concentrated data, the arsenic concentration in the

sample corresponded to the concentrations of arsenic added (0 and 1 ppb) shown in Figure 2.8.

Because the man-made campus pond collects runoff, and is a habitat to many wildlife, the lack of circulation may result in presence of chemicals that could interfere with the arsenic signal. To determine the effect of the matrix on the arsenic signal, the collected pond water was spiked with 10 and 20 ppb of arsenic and the percent recovery is shown in Figure 2.8. Slight signal suppression was observed only for MMA, and not for As(III), As(V) or DMA, as can be seen in Figure 2.9. With the consistent result achieved from the pre-concentration procedure, the method was applied to the campus pond water, when the sample was pre-concentrated before analysis. The sample (60 mL) was passed through the column at  $3 \text{ mL min}^{-1}$ , followed with elution by nitric and acetic acid (6 mL each) at  $1 \text{ mL min}^{-1}$ , obtaining a pre-concentration factor of 10, as shown in Figure 2.10. Arsenite could not be retained in any of the columns and was omitted. The pond water (unspiked sample), along with arsenic-spiked pond water, were speciated. The results are shown in Figure 2.10, from which it can be seen that both samples contained roughly 1 ppb of As(V), DMA and MMA combined, presented in.

## 2.4 Conclusions

Solid phase extraction is a reliable method of arsenic speciation yielding close to 100% recovery consistently. Some minor modifications were made to the procedure upon Cai's, et al.<sup>8</sup> method. Between elution with acid, the columns were washed with deionized water to remove the residual As(III) from the columns. This minor adjustment resulted in 100% recovery of As(III). From the flow rate optimization studies,  $3 \text{ mL min}^{-1}$

<sup>1</sup> was the fastest flow rate that yielded the smallest standard deviation values, so 3 mL min<sup>-1</sup> was used for introducing the samples to the SPE columns.

The non-polar columns did not retain the majority of the arsenic species but the results were inconsistent and the columns were not used. The University's campus pond water was speciated and analyzed for the presence of arsenic with the method developed for the speciation of arsenic in deionized water. Pre-concentration and speciation by solid phase extraction coupled to HG-AAS revealed that the pond water contained less than 1 ppb of arsenic, and that the species were a combination of As(V), DMA and MMA.

**Table 2.1:** FI-HG-AAS Parameters

---

*FI-HG-AAS Parameters*

---

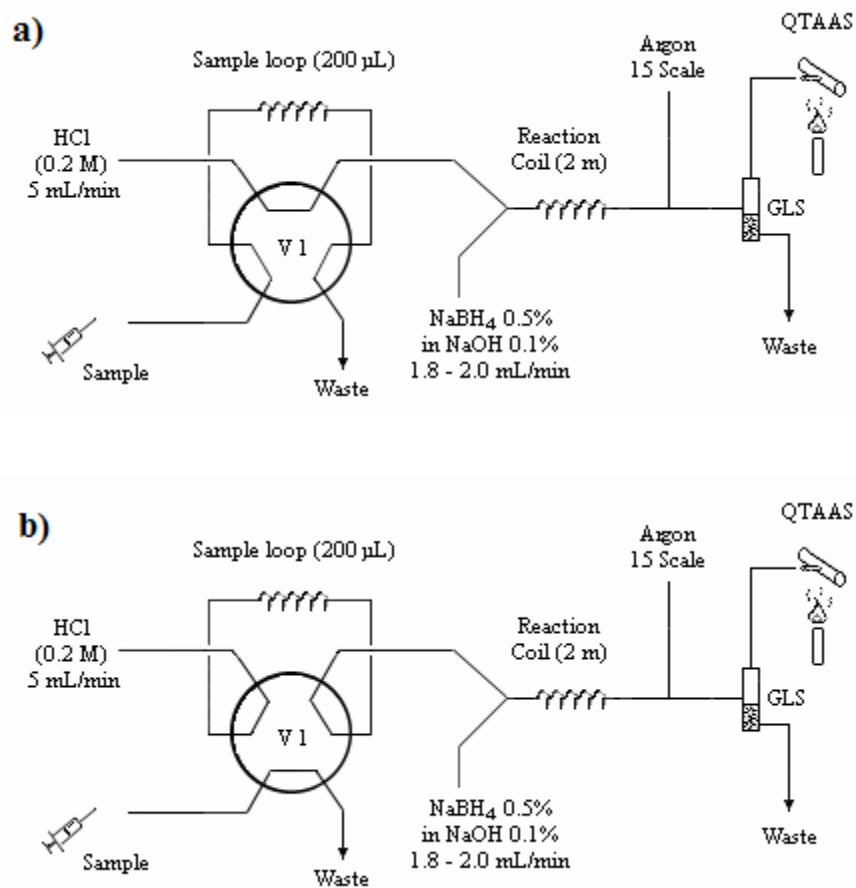
*FI-HG*

Sample loop	200 $\mu\text{L}$
NaBH <sub>4</sub> Concentration (w/v %) In 0.1% NaOH	0.5
NaBH <sub>4</sub> Flow Rate (mL min <sup>-1</sup> )	1.8
HCl (0.2 M) Flow Rate (mL min <sup>-1</sup> )	5

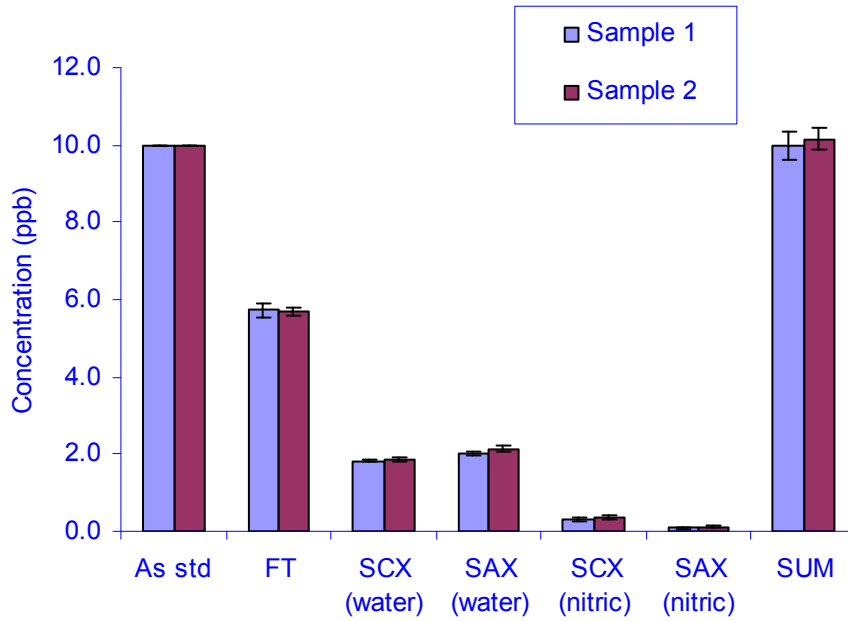
*AAS*

Argon Flow Rate (mL min <sup>-1</sup> )	120
Reaction Coil (m)	2
Arsenic Wavelength (nm)	193.7
Slit Width (nm)	0.7
Quartz Tube	
Length (cm)	16
Diameter (mm)	8

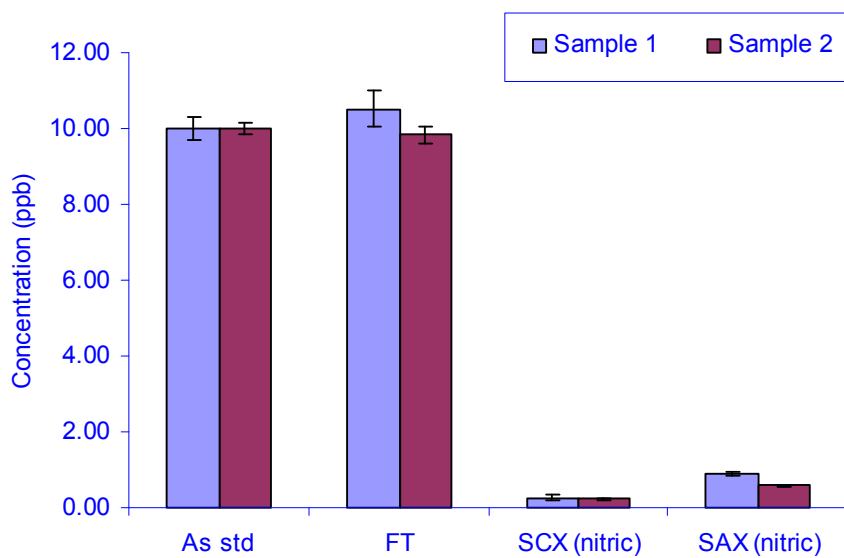
---



**Figure 2.1:** Layout of the FI manifold, with valve V1, in the load position (a), and injection position (b).

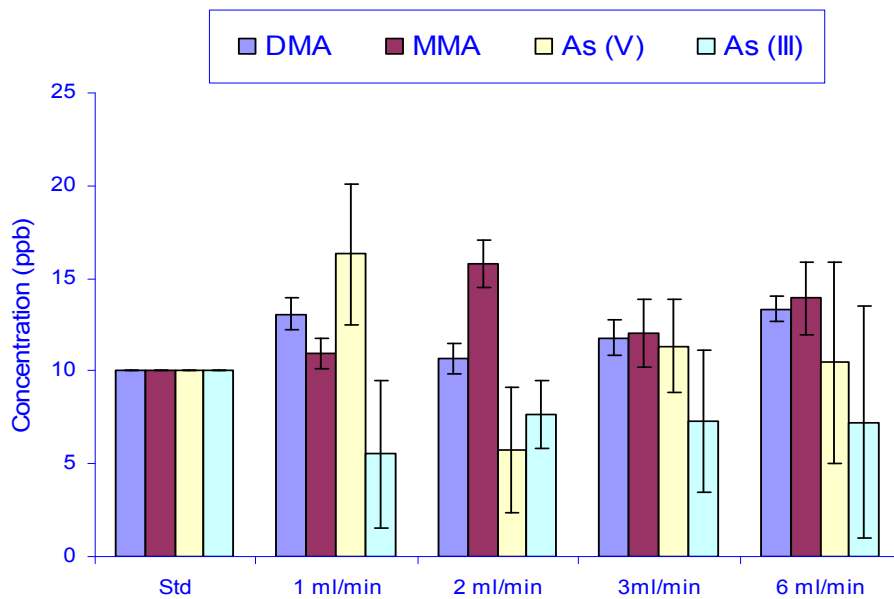


**Figure 2.2:** Less than 60% of As(III) eluted after being passed through the SCX and SAX columns (FT). The columns were then washed with 5 mL of deionized water (SCX and SAX water) followed by 5 mL of nitric acid (SCX and SAX nitric acid) to remove the residual As(III) from the columns. (Std refers to the sample before passing through the columns). Error bars are generated based on 95% confidence interval of the data.

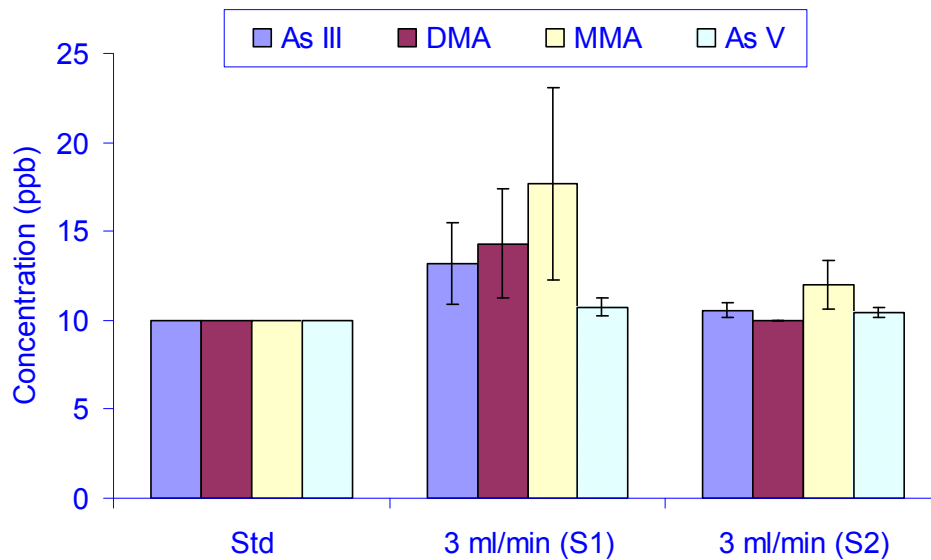


**Figure 2.3:** As(III) ran through both columns, followed by elution with 5 mL deionized water (FT), then with 5 mL 1 M HNO<sub>3</sub> (SCX and SAX nitric) to remove any residual As(III). FT is back calculated from the 1.5x deionized water dilution. (Std refers to the sample before passing through the columns) Error bars are generated based on 95% confidence interval of the data.

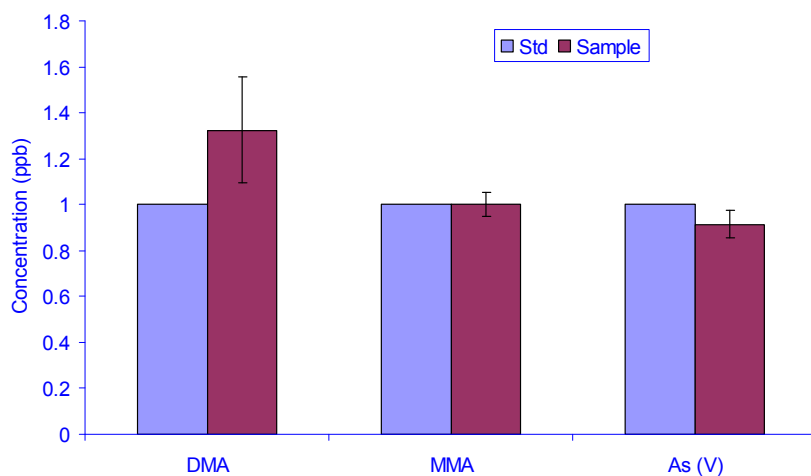




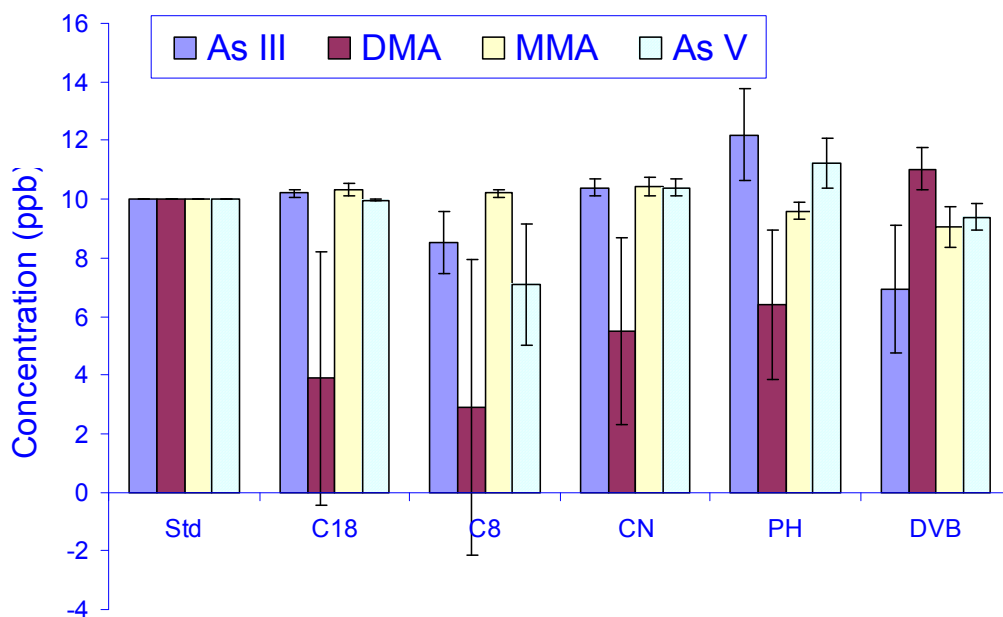
**Figure 2.4:** Various flow rate of sample through the SCX and SAX column (controlled by peristaltic pumps) was optimized for application of pre-concentration. (Std refers to the sample before passing through the columns) Error bars are generated based on 95% confidence interval of the data.



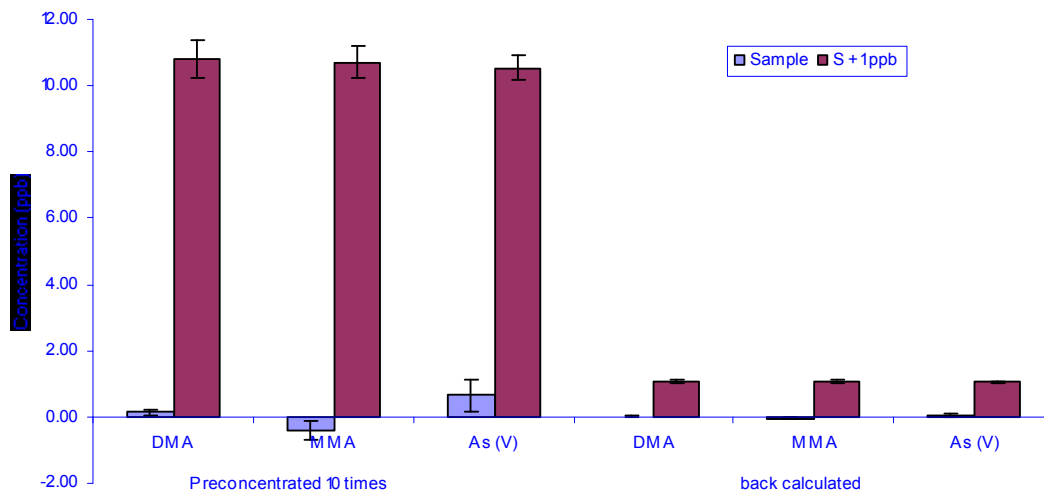
**Figure 2.5:** Arsenic (10 ppb) was speciated then quantified by SPE-HG-AAS. The investigations were conducted with a flow rate of  $3 \text{ mL min}^{-1}$  and washing with nitric acid and acetic acid at  $1 \text{ mL min}^{-1}$ . (Std refers to the sample before passing through the columns) Error bars are generated based on 95% confidence interval of the data.



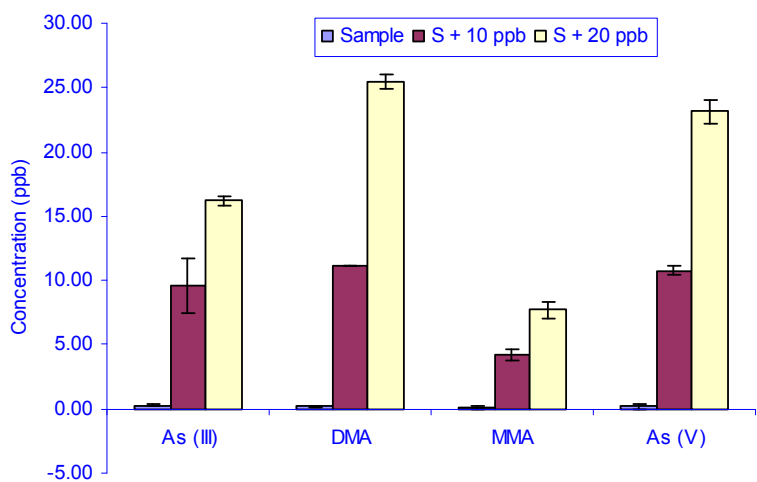
**Figure 2.6:** Accuracy of pre-concentration using SPE method was tested with 30 mL of deionized water spiked with 1 ppb of arsenic, eluting with 3 mL 1 M HNO<sub>3</sub> and then with 0.1 M CH<sub>3</sub>COOH. (Std refers to the sample before passing through the columns) Error bars are generated based on 95% confidence interval of the data.



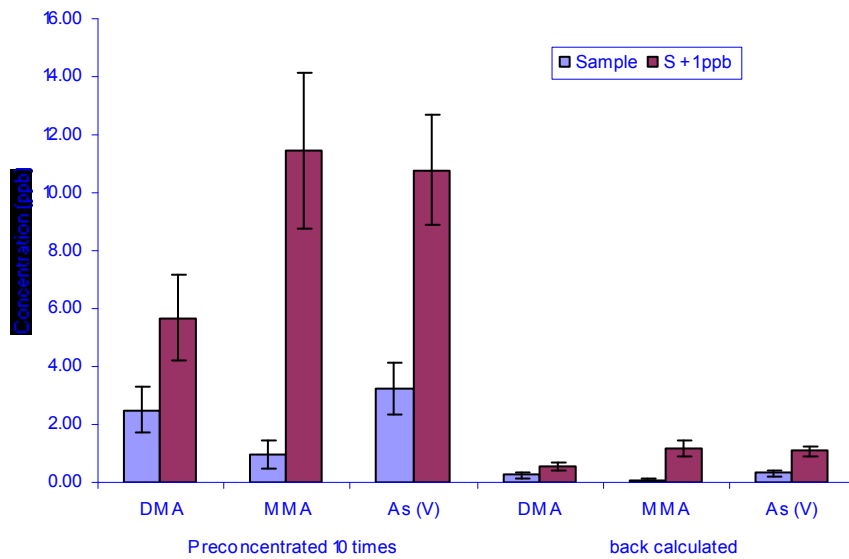
**Figure 2.7:** Different non-polar silica packing materials tested to find the material that retain the least amount of arsenic. From left to right, the materials tested included, hydrocarbons (C18 and C8), cyanopropyl (CN), phenyl (PH), and divinylbenzene (DVB). (Std refers to the sample before passing through the columns) Error bars are generated based on 95% confidence interval of the data.



**Figure 2.8:** Deionized water, and arsenic-spiked deionized water samples speciated with SPE. The first 6 bars represent pre-concentrated samples, and the last 6 bars are back calculated to the original concentration revealing 0 and 1 ppb of arsenic in the original and spiked samples respectively. Error bars are generated based on 95% confidence interval of the data.



**Figure 2.9:** Pond water was spiked with arsenic and quantified by HG-AAS. Recovery of 10 and 20 ppb of arsenic in campus pond water to study the effect of the matrix on the signal. Error bars are generated based on 95% confidence interval of the data.



**Figure 2.10:** Pond water, and arsenic spiked pond water sample, speciated with SPE. The first six columns showed ten times pre-concentration of campus pond water. Back calculation revealed total of 0.67 ppb of arsenic (all three species). Error bars are generated based on 95% confidence interval of the data.

## 2.5 References

- (1) The World Health Organization: Arsenic in drinking water. 2001. <http://www.who.int/mediacentre/factsheets/fs210/en/>. (Date accessed: 4.22.07)
- (2) van Elteren, J.T., Stibilj, V., and Šlejkovec, Z. *Water Res.* **2002**, *36*, 2967-2974.
- (3) Antony, P.J., Karthikeyan, S., Iyer, C.S.P. *Chromatography B.* **2002**, *767*, 363-368.
- (4) Lindberg, A., Goessler, W., Grandér, M., Nermell, b., and Vahter, M. *Toxicol. Lett.* **2007**, *168*, 310-18.
- (5) Prohaska, T., Pfeffer, M., Tulipan, M., Stingeder, G., Mentler, A. and Wenzel, W. *Fresenius J. Anal. Chem.* **1999**, *52*, 583.
- (6) Adriano, D., Page, A., Elseewi, A., Chang, A. and Starughan, I. *Environ. Qual.* **1980**, *9*, 323.
- (7) Chakraborti, D., Chatterjee, A., Das, D., Mandal, B., Chowdhury, T., and Samanta, G. *Analyst* **1995**, *120*, 643-650.
- (8) Cai, Q., Yu, C., Guo, Z., Yang, Z., and Khoo, S. *Spectrochim Acta Part B.* **2003**, *58*, 1335-1349.



## CHAPTER 3

# SPECIATION OF ARSENIC BY LIQUID CHROMATOGRAPHY – HYDRIDE GENERATION INDUCTIVELY COUPLED PLASMA OPTICAL EMISSION SPECTROMETRY

### 3.1 Introduction

Seawater usually has a total arsenic concentration of around 1-5 ppb, in the forms of As(III), As(V), MMA, and DMA, while arsenic found in the marine food chain is mainly in the organic forms of AsB (also known as trimethylarsonioacetate), arseno-sugars, and other methylated forms of arsenic.<sup>1</sup> The most common form of arsenic found in algae includes inorganic arsenic and arseno-sugars. Arsenocholine is believed to be the precursor of AsB,<sup>2</sup> a metabolically stable form of arsenic, and is thought to be the final metabolite of the food chain. Arsenobetaine has been identified as the major form of arsenic found in fish, bivalves, and crustaceans; DMA is a minor species,<sup>1</sup> along with trace amounts of As(V), AC, and TeMA.<sup>1</sup> Death and decay of marine animals should release AsB back into the ocean, but contrary to what is expected, this species of arsenic is never found in seawater.<sup>3</sup> Jenkins and Ritchie et al. suggested that there are microbial processes that degrade arsenobetaine into a different form of arsenic.<sup>3</sup>

Although the exact biosynthetic pathway for AsB is still unknown,<sup>1</sup> arsenobetaine is generally formed from arseno-sugars via different methylation and adenosylation pathways. Jenkins et al.<sup>4</sup> have isolated two species of bacteria from blue mussels, *M. edulis*. By analyzing the cell lysates from one of the isolated bacteria, *Pseudomonas fluorescens*, Jenkins noticed that the bacteria are capable of degrading AsB to

dimethylarsinate and dimethylarsinoylacetate.<sup>4</sup> Jenkins suggested that with the help of *Carcinus maenas* (a microorganism extracted from shore crab), TMAO is formed by cleavage of the carboxymethyl-arsenic bond in AsB, followed by cleavage of the methyl-arsenic bonds forming DMA and MMA,<sup>3</sup> as shown in Figure 3.1.

On the other hand, MMA, DMA, As(III) and As(V) are more commonly found in human urine with the addition of AsB after seafood consumption. Unlike other species of arsenic, AsB is not retained in the body and is excreted within 1-3 days.<sup>5</sup> Jenkins and Ritchie studied the metabolic processes in *P. fluorescens*, a bacteria isolated from *M. edulis*, in which arseno-sugar species are converted to AsB as a final product in marine species, as schematically shown in Figure 3.2. Kuroda and Yoshida et al. showed that *E. coli* in rat intestine metabolized TMAO, yielding an unidentified arsenic compounds in which they named M-1, while DMA yielded two unidentified compounds known as M-2 and M-3.<sup>6</sup> One of the strains metabolized DMA to TMAO before metabolizing it further to form M-1. Besides marine species, AsB also exists in mushrooms and earthworms living in arsenic contaminated environments.<sup>4</sup>

Arsenic is first accumulated in the liver, spleen, kidneys, lungs and gastrointestinal tract after consumption or inhalation but is excreted rapidly through the kidneys.<sup>5</sup> However, 2 to 4 weeks after exposure, most of the arsenic remaining in the body is found in keratin-rich tissues such as skin, hair and nails, and to a lesser extent in the bones and teeth.<sup>5</sup> Long term exposure to arsenic results in diseases such as lung and skin cancer, conjunctivitis, hyperpigmentation, cardiovascular disease, gangrene and disturbances in the peripheral vascular and nervous system.<sup>5,7</sup>

There are several analytical methods of arsenic speciation, most of which are based on chromatographic separation, including high performance liquid chromatography (HPLC).<sup>8</sup> As previously discussed, because of the different ionic characteristics of the different arsenic species at a designated pH, an ion-exchange column could be used to separate the various species up to a certain degree. Although solid-phase extraction is a widely used method of separation because of its simplicity and low-cost, HPLC allows for greater range of separation, yields more reproducible data, and is less likely to be affected by the matrix. On an anion-exchange column, AsB and As(III) will not be retained and will elute with the solvent front. DMA is slightly retained and is the next species eluted, followed by MMA and As(V).

Inductively coupled plasma optical emission spectrometry (ICP-OES) offers several advantages over various spectroscopic instruments such as AAS and AFS including lower detection limit and analysis of multiple elements simultaneously. Although mass spectrometry may have a slightly lower detection limit compared to OES, isobaric interference (from  $^{40}\text{Ar}^{35}\text{Cl}^+$  vs. monoisotopic  $^{75}\text{As}^+$ ) and signal depression from salt makes ICP-OES preferable. Furthermore, when coupled with hydride generation, the signal can be improved significantly, lowering the effect from the matrix. This investigation, whose results are discussed in this chapter, focused on speciation and quantification of arsenic metabolized by *E. coli*, with HPLC coupled to ICP-OES.

## **3.2 Experimental**

### **3.2.1 Instrumentation**

This investigation was conducted with Optima 4300 DV, an inductively coupled plasma optical emission spectrometer (Perkin Elmer Instruments, Shelton, CT, USA)

coupled with HPLC. After chromatographic separation, the analytes leaving the column were introduced to the spectrometer as hydride vapor with the assistance of the multimode sample introduction system (MSIS) (Perkin Elmer Instruments, Shelton, CT, USA). The parameters of the systems are shown in Table 3.1.

The pump used for the liquid chromatographic separation was a binary gradient pump (Finnigan SpectraSYSTEM P2000), which was connected to an auto-sampler with a built-in injector valve connecting to a 100- $\mu$ L sample loop (Finnigan SpectraSYSTEM AS3000), both supplied by the Thermo Electron Corporation, Waltham, MA. Concentrated hydrochloric acid (12 M HCl), flowing at 0.1 mL min<sup>-1</sup>, controlled by a peristaltic pump (Ismatec SA-MS-Reglo peristaltic pumps, Cole Parmer), was introduced to the stream of sample flowing from the HPLC anion-exchange column via a T-junction. The acidified sample entered the MSIS to react with the stream of 1.5% NaBH<sub>4</sub> (in 0.1% NaOH) producing arsine gas, which was then carried into the plasma by argon gas. The schematic layout of this system is shown in Figure 3.3.

### **3.2.2 Method Development**

The methods used in this investigation were developed by Khalid Al-Assaf.<sup>9</sup>

In order to verify that the different species of arsenic yield signals at equal intensity when no matrix was involved, standards were analyzed by ICP-OES. The standards were prepared in deionized water at concentrations ranging from 0 to 300 ppb of arsenic. The sensitivities for the calibrations for arsenobetaine, As(V) and DMA are statistically the same, based on the application of t-tests to the slopes. Although the slopes of the calibrations for MMA and As(III) are statistically the same, they are significantly a different from the slopes for than the other three species. The calibrations

are shown in Figure 3.4. Arsenobetaine is not converted to arsine gas when mixed with borohydride solution. So in Figure 3.5, at the same concentrations as DMA, the signal intensity of AsB signal is close to twenty times lower than that of DMA. At 1 ppm, without hydride generation, the DMA and AsB chromatograms yielded the same peak areas, shown in Figure 3.6, which agrees with a previous study without the use of HPLC, shown in Figure 3.4. Without hydride generation, the arsenic signals are too low to be detected even at concentrations as high as 0.50 ppm. Thus, the remaining studies were conducted with hydride generation.

The cells in this investigation were grown in Mueller-Hinton broth as previously described. Most species of arsenic investigated (AsB, As(III), and As(V)) were not affected by the matrix. But the MH broth created a split peak effect with DMA. Various studies were conducted to improve the resolution of DMA in MH broth. The pH of the media was adjusted to vary between 7.39 (no adjustment) to 2.39 with nitric acid, while maintaining the concentration of DMA at 1 ppm. Although the decrease in the pH caused the two peaks to migrate towards each other, the DMA peak was still split into two very distinct peaks, as shown in Figure 3.7. Table 3.2 shows that even though the peak shapes are slightly altered and are closer together at lower pH, the peak areas remains the same. A dilution study, where MH was diluted to several concentrations, was also conducted. The dilution ranged from 100 % MH, no water added, to 0 % MH, where DMA is diluted to 1 ppm solely in deionized water. Even at a much diluted concentration of 1 part MH and 7 parts water, the chromatogram of DMA still yields a split peak, shown in Figure 3.8. When the media was diluted, the retention time of DMA decreased, suggesting that DMA reacted with the media forming a positive complex. Because cells will not grow if

the food source is insufficient and it is very difficult to dilute the media with water without also diluting the concentration of the arsenic, quantification of DMA included the total area of the two peaks. Table 3.3 shows the area under the peak is fairly constant, and MH broth did not affect the intensity of the signal.

### **3.2.3 Speciation of Arsenic in Mueller-Hinton Broth**

Species of arsenic studied included AsB, DMA, As(III) and As(V). Each of these species was added to test tubes containing the media, first without *E. coli* in order to develop a reliable method of analysis based on the effect of the matrix. Various concentrations of arsenic were used to create a calibration curve based on the peak areas of the chromatograms. Both deionized water and MH media matrices were analyzed. Sample preparations typically required 24 hours of incubation (except for time trials for As(V) reduction rate by *E. coli*, in which reaction time varied from 0 to 48 hours) at 37 °C on a shaker for optimum cell growth. The cells were then centrifuged and the supernatant was analyzed as MH media. Water was then added to the cell debris and sonicated and left on a shaker overnight for extraction. The cells were once more centrifuged and the supernatant was analyzed as water extract. For controls, tubes containing only arsenic and no cells were incubated overnight and analyzed.

### **3.3 Results and Discussions**

Initially, SPE coupled with ICP-OES methods developed from previous studies were applied in speciation of arsenic from *E. coli* cells and the growth media. The results obtained were inconsistent. Thus, HPLC coupled with ICP-OES detection was developed to replace speciation by SPE.

First a mixture of AsB, DMA and As(V), at 1 ppm in deionized water each, was separated using HPLC and detected with HG-ICP-OES. Arsenobetaine was not retained in the column and was eluted with the solvent front, DMA was second to leave the column, followed by As(V), shown in Figure 3.9. This was repeated with 0.5 and 0.1 ppm for quantification. The same procedure was repeated in MH media instead of water. The chromatogram of DMA yielded a split peak as a result of the matrix effect, some with longer retention time, the rest, with shorter retention times, Figure 3.10 (a), which in turn overlapped with the AsB peak, Figure 3.10 (b).

Based on preliminary experiments, *E. coli* reduces As(V) to As(III), then releases it back into the environment. The arsenic metabolism rate by the bacteria was investigated by analyzing the MH broth every 15 minutes for 2 hours, shown in Figure 3.11 (a). The two hour time period was too short and didn't yield as much As(III) as expected, so the investigation was conducted over 48 hour, with 1 hour time intervals for the first 6 hours shown in Figure 3.11 (b). The concentration of As(III) increased minimally for the first 6 hours as the concentration of As(V) decreased. The concentration of As(III) increased significantly after 24 and 48 hours of incubation from 0.063 ppm to 0.52 ppm and 1.27 ppm respectively, as can be seen in Table 3.4. Inversely, the concentration of As(V) decreased from initial concentration of about 0.23 ppm to 0.04 ppm after 48 hours.

Arsenite and DMA on the other hand were not metabolized further into other species of arsenic. So an investigation was conducted on how much arsenic the cells could retain. After 48 hours of inoculation with 1 ppm arsenic and extraction, both the MH media and the water extractant were analyzed using standard addition methods,

where 125 and 250 ppb of arsenic were added to the sample immediately before the analysis. Figure 3.12 and 3.13 show the analysis of the solvent (MH and deionized water) of As(III) and DMA respectively, where (a) is the control, with no cells added, (b) is the MH media after 24 hours of incubation, and (c) is the chromatogram of arsenic extracted from the cells with water and sonication. The arsenic extracted from the cells (water extraction) only had concentration of about 6 ppb for DMA and 3 ppb for As(III). At higher concentrations, more arsenic is stored in the cells. *E. coli* were grown in media contaminated with either As(III) or DMA, at concentrations ranging from 2.5 ppm to 10 ppm, presented in Figure 3.14 (a) and 3.15 (a) respectively. The extractant of the cultures were analyzed, showing that higher concentrations of arsenic in the environment resulted in the cells storing higher concentrations of arsenic, shown in Figure 3.14 (b) and 3.15 (b). Table 3.5 shows the concentration of arsenic in the environment was linearly proportion to the amount of arsenic stored in the cells.

### **3.4 Conclusions**

#### **3.4.1 Intensities of Various Arsenic Species Measured with ICP-OES**

From the preliminary investigation of measured intensities of arsenic species it was concluded that the five species of arsenic studied do not give the same intensities when measured by ICP-OES without hydride generation, which is contradictory to what is commonly accepted. One of the contributing factors was the different rate at which the atoms can form molecular species. Some of the arsenic species, namely As(III) and MMA, form molecular species easier than others, resulting in lowered intensities of the species when simply measuring only the atomic emission.



### 3.4.2 Retention Time of DMA in MH broth

The chemistry of DMA is not well understood. At pH below 6.2, the dominant species of DMA is neutral, although its retention behavior on an ion-exchange column resembles that of a positive species. When DMA is introduced to MH media, the retention time varies dramatically from DMA in water matrix. When speciating with HPLC, the MH broth caused a large bulk of DMA to elute from the anion-exchange column much faster compared to DMA in water matrix. As the media was diluted with water, the analyte was better retained by the column and eluted at a later time. DMA is known to react well with irons and thiol groups, which are present at high concentration in the media in the form of protein. The retention behavior suggested that DMA reacted with the media, forming a more positive molecule, resulting in shorter retention time.

### 3.4.3 Detoxification of Arsenic

Many researchers had suggested methylation of arsenic by *E. coli* as means of detoxification, forming organic arsenic species from inorganic species. According to Kuroda, et al,<sup>6</sup> when *E. coli* were exposed to arsenic contaminated environments, especially DMA, unknown species of arsenic currently named M-1, M-2 and M-3 were synthesized. The results obtained from the anion-exchange chromatography yielded contradictory results. The investigation conducted did not show any evidence of methylation of arsenic but only suggested the reduction of As(V) to As(III) as a detoxification process. When the cells were grown in As(III) and As(V) contaminated media, there were no evidence of other species of arsenic beside the original species introduced (As(III) and As(V)) and formation of As(III) from the reduction of As(V). Within 48 hours time period while nutrition was still sufficient, the bacteria reduced most

of the As(V) present in their environment to As(III). When DMA was introduced to the bacteria's environment, the MH media analysis had shown the original species of DMA and the cell extract water analysis shown only the presence of the analyte in the cells.

**Table 3.1: HPLC-MSIS-HG-ICP-OES Parameters**

---

*HPLC-MSIS-HG-ICP-OES Parameters*

---

*HPLC* *All systems were operated at ambient temperature*

Sample Loop Size ( $\mu\text{L}$ ) 100  
Anion-exchange Column Alltech Anion/R 10  $\mu\text{m}$   
Mobile Phase A: 10 mM  $(\text{NH}_4)\text{H}_2\text{PO}_4$  pH 5.8  
B: Deionized water

Gradient Program

Time (min)	A %	B %	Flow Rate ( $\text{mL min}^{-1}$ )
0.0	0	100	1.00
3.0	0	100	1.00
8.0	100	0	1.00
8.1	100	0	2.00
11.0	100	0	2.00
11.1	0	100	2.00
12.1	0	100	2.00

*MSIS*

$\text{NaBH}_4$  Concentration (w/v %) 1.5  
In 0.1% NaOH  
 $\text{NaBH}_4$  Flow Rate ( $\text{mL min}^{-1}$ ) 1.5  
HCl (12 M) Flow Rate ( $\text{mL min}^{-1}$ ) 0.1  
Sample Flow Rate ( $\text{mL min}^{-1}$ ) 1.5

*ICP-OES*

Arsenic Wavelength (nm) 288.812  
RF Power (W) 1400  
Plasma View Distance (cm) 15.0 (axial)  
Auxiliary Flow Rate ( $\text{L min}^{-1}$ ) 0.2  
Nebulizer Flow Rate ( $\text{L min}^{-1}$ ) 0.55

---

**Table 3.2:** DMA in MH Media at Different pH

<i>pH</i>	<i>Peak Area (counts)</i>
7.39	777000
5.66	844000
3.46	725000
2.39	745000

**Table 3.3:** DMA at different concentrations of MH

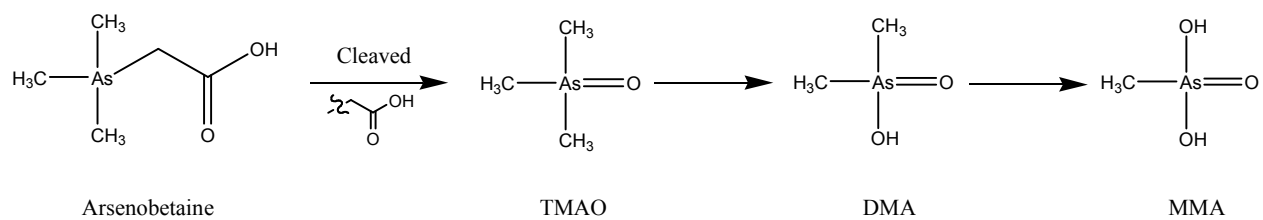
<i>Parts MH</i>	<i>Parts Water</i>	<i>Peak Area (counts)</i>
8	0	727000
6	2	783000
4	4	802000
2	6	831000
1	7	885000
0	8	819000

**Table 3.4:** Time Dependent Metabolism of As(V)

<i>Time (hours)</i>	<i>As(III) (ppm)</i>	<i>As(V) (ppm)</i>
0	0.063	0.232
1	0.071	0.243
2	0.150	0.428
3	0.157	0.225
4	0.154	0.376
5	0.179	0.212
6	0.256	0.269
24	0.520	0.188
48	1.270	0.039

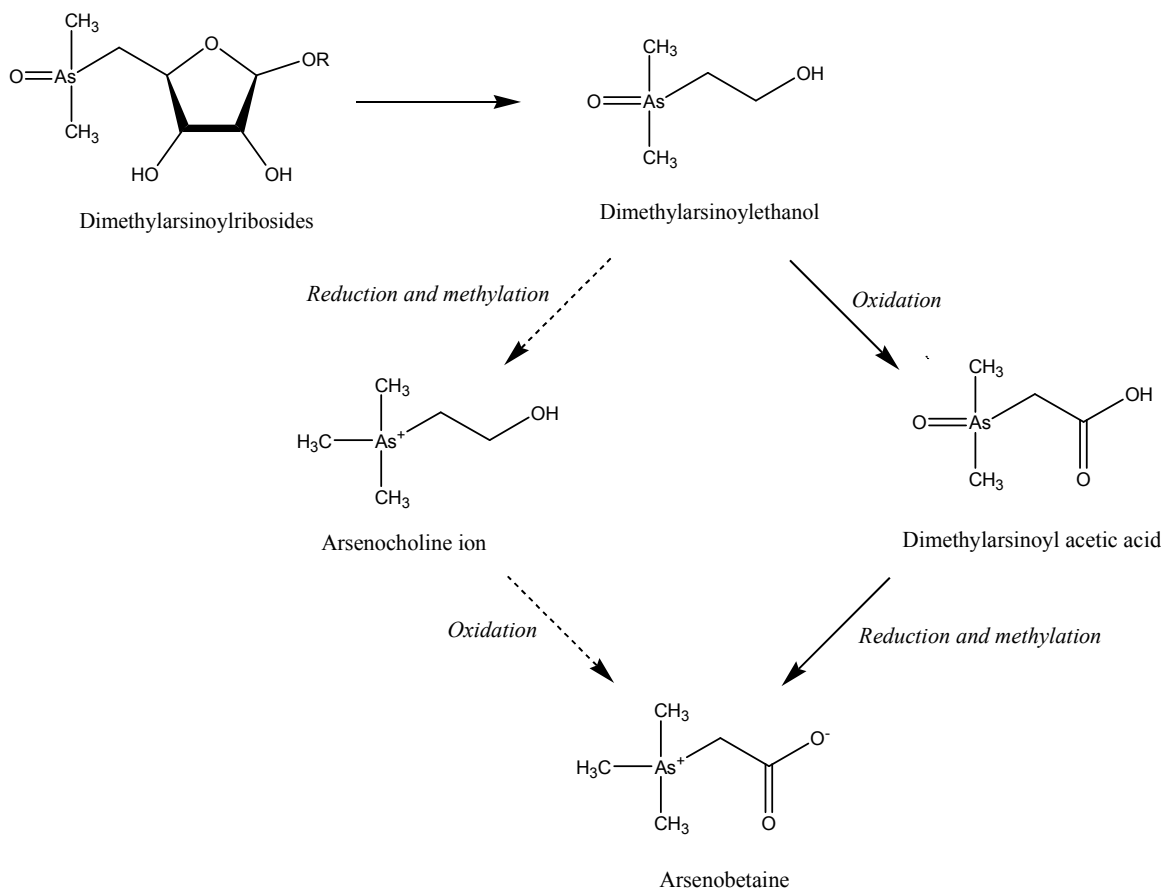
**Table 3.5:** Arsenic Uptake of *E. coli* at High Concentration

<i>Concentration added (ppm)</i>	<i>DMA (ppm)</i>	<i>As(III) (ppm)</i>
2.5	0.077	0.053
5.0	0.202	0.464
7.5	0.468	0.847
10.0	0.506	1.001

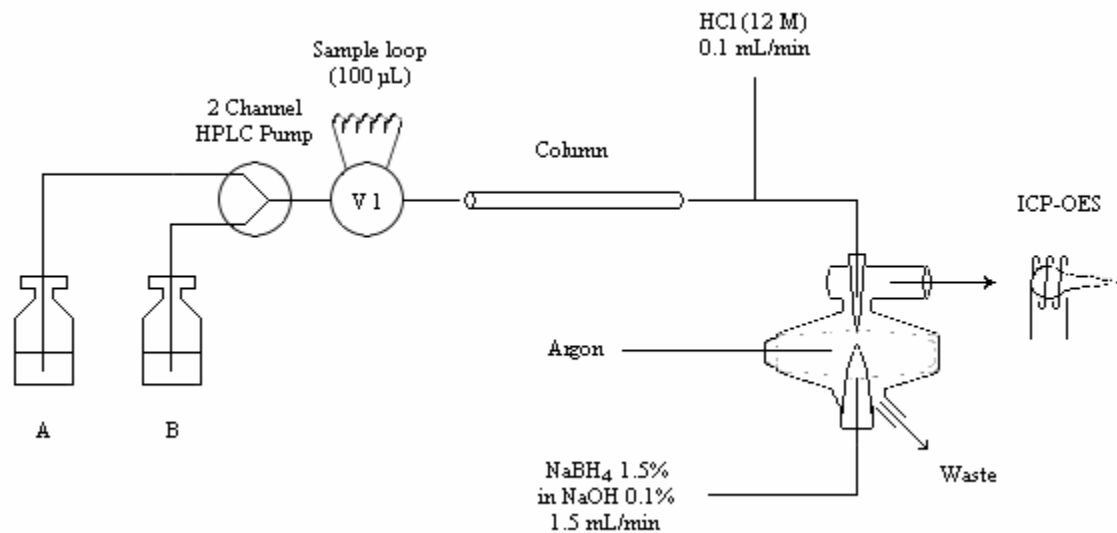


**Figure 3.1:** Reaction scheme of TMAO, DMA and MMA formation from AsB suggested by Jenkins, et al. as an explanation to why AsB is not found in sea water.<sup>3</sup>

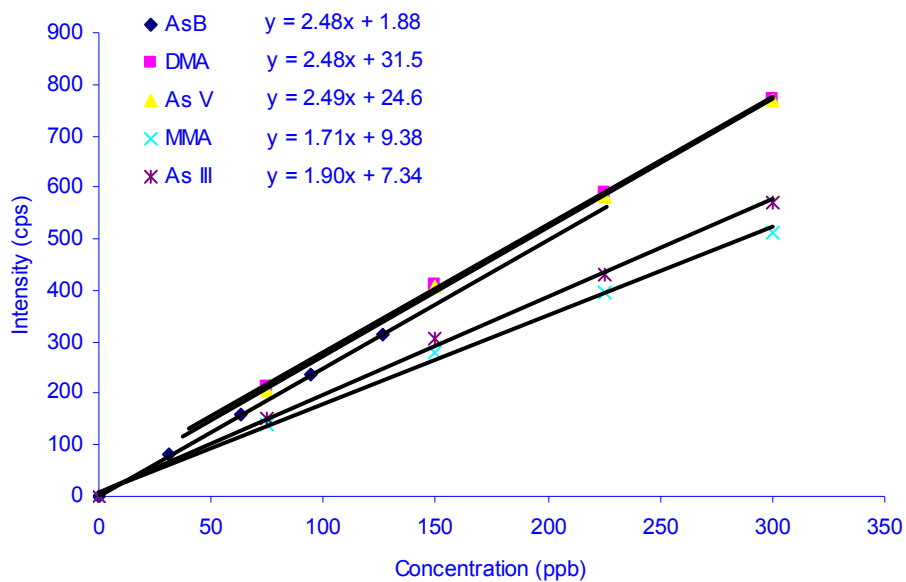




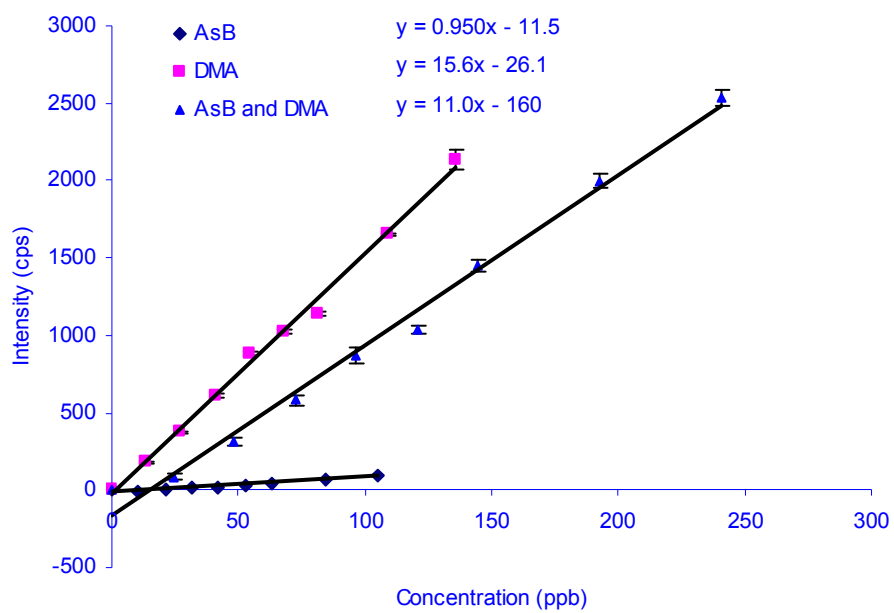
**Figure 3.2:** Schematic description for the biosynthesis of arsenobetaine from dimethylarsinoylribosides proposed by Jenkins, et al.<sup>3</sup>



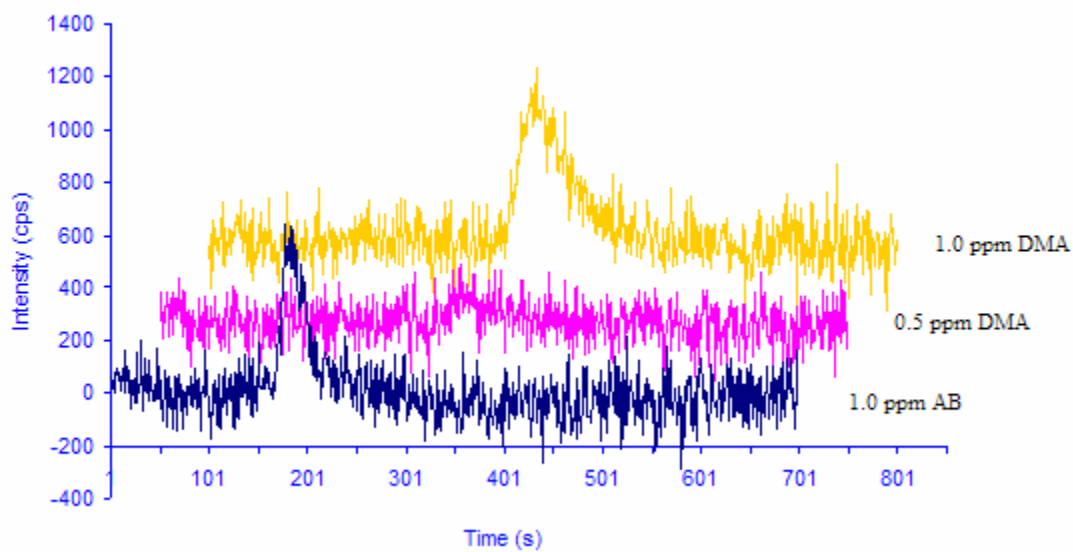
**Figure 3.3:** Layout of the HPLC-HG-ICP-OES system, where V1 is the auto sampler injection valve, and the column used was an Alltech Anion R/10 µm.



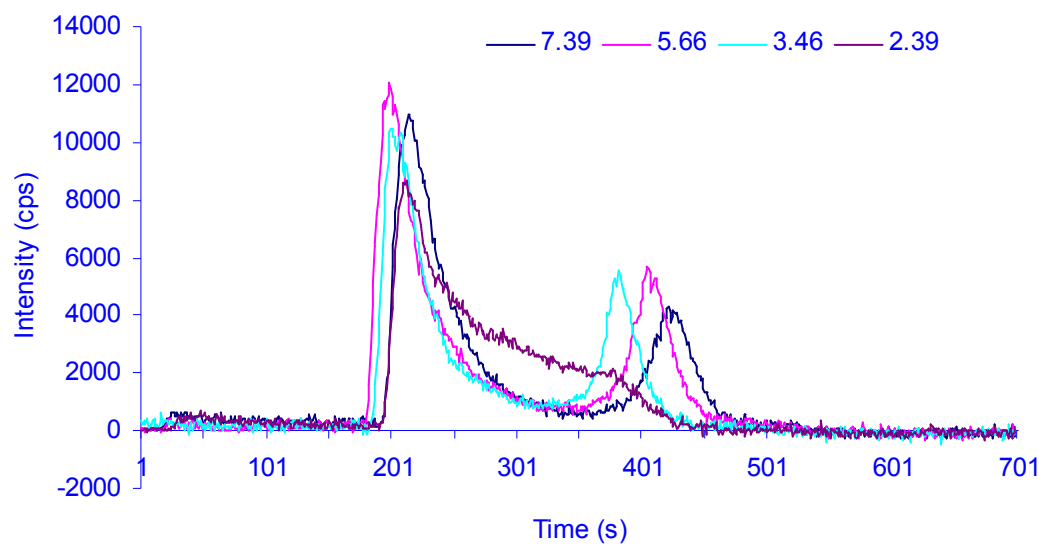
**Figure 3.4:** Calibration functions for various arsenic species in water by ICP-OES. Without hydride generation, the intensities of the signal for all arsenic species should be the same. Based on t- and F-tests at 95% confidence, AsB, DMA and As(V) are statistically the same, and MMA and As(III) are statistically the same.



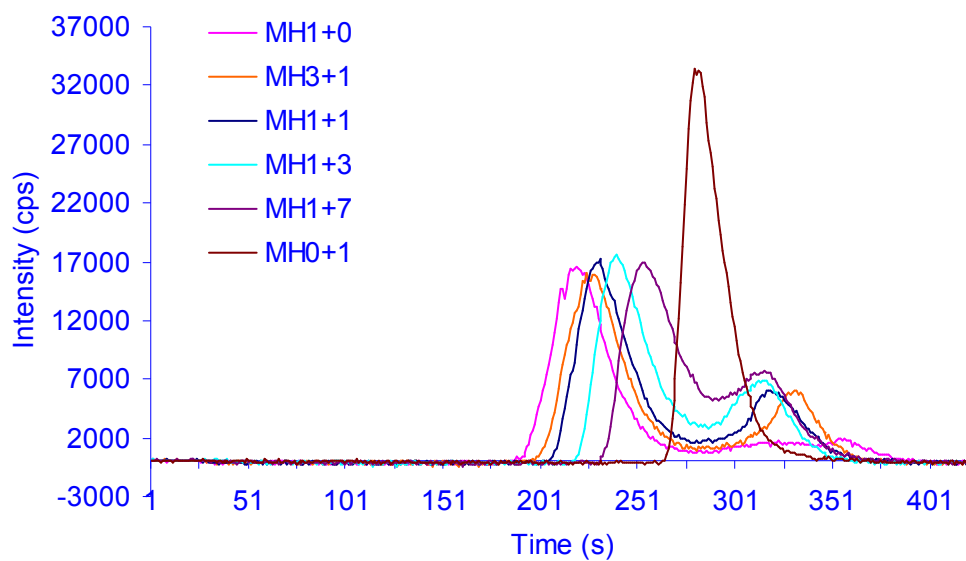
**Figure 3.5:** Calibration for analysis of AsB (non-hydride reactive species) and DMA (hydride reactive species) in water with hydride generation by ICP-OES.



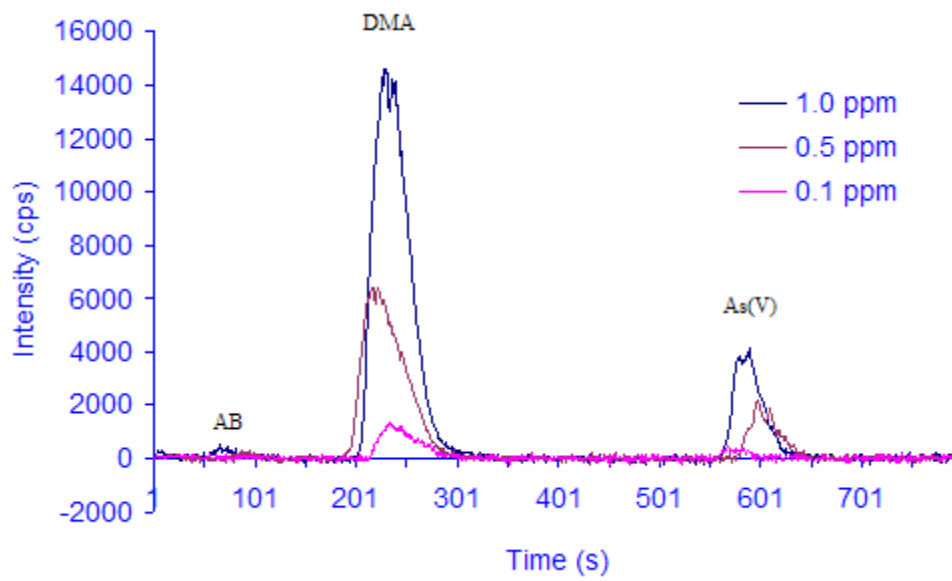
**Figure 3.6:** Chromatograms of AsB (not hydride reactive) and DMA (hydride reactive) in water with hydride generation by ICP-OES.



**Figure 3.7:** Chromatograms of DMA (1 ppm) in MH media at various pH values, between 7.39 and 2.39, to determine the best pH for a better resolution. The pH of the media is adjusted with nitric acid.

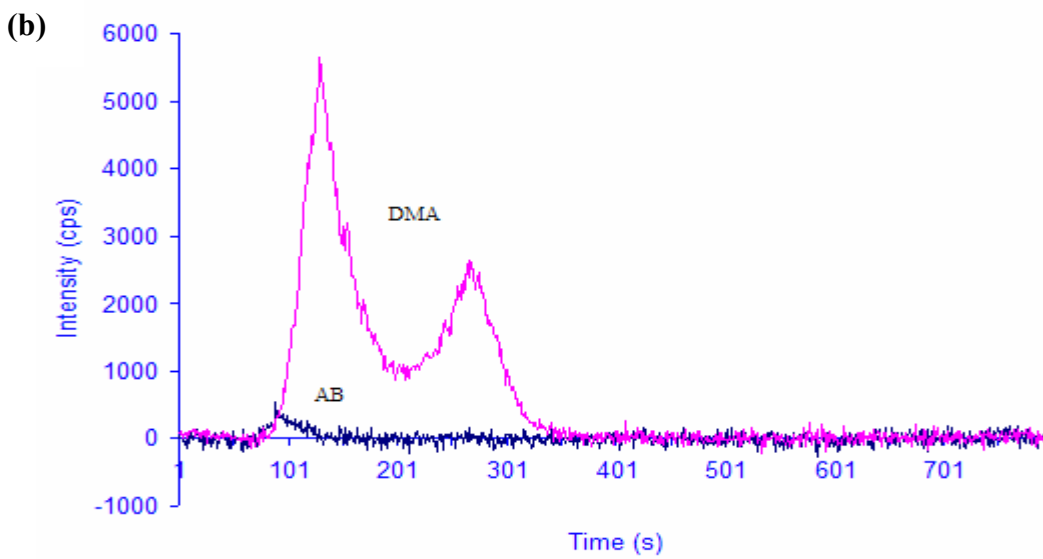
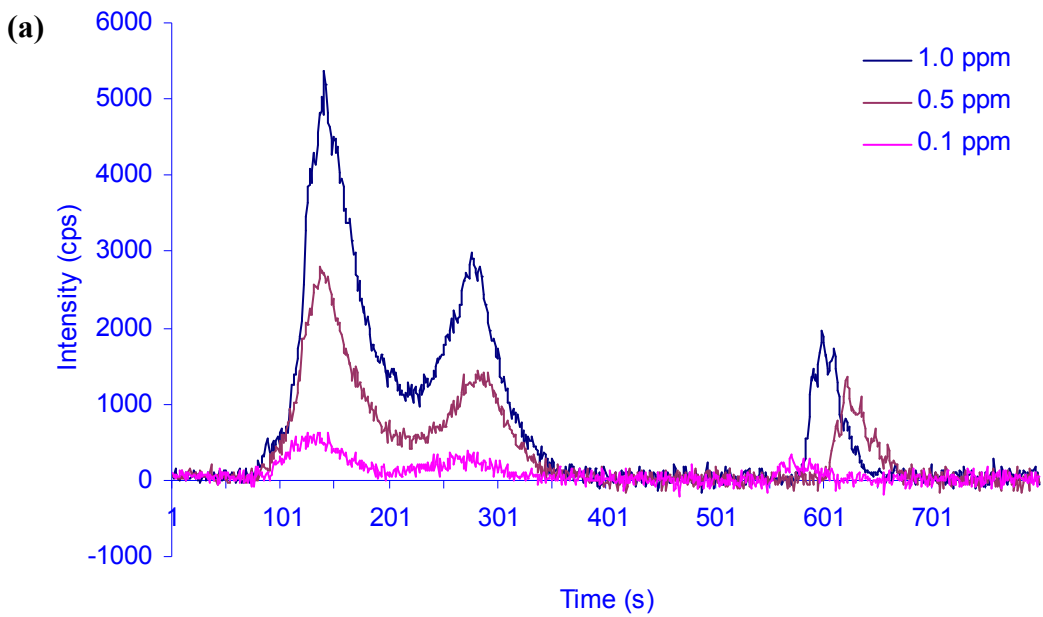


**Figure 3.8:** Chromatograms of DMA (1 ppm) in MH media at various dilutions with water, ranging from 1 part MH, 0 part water (top) to 0 part MH and 1 part water.

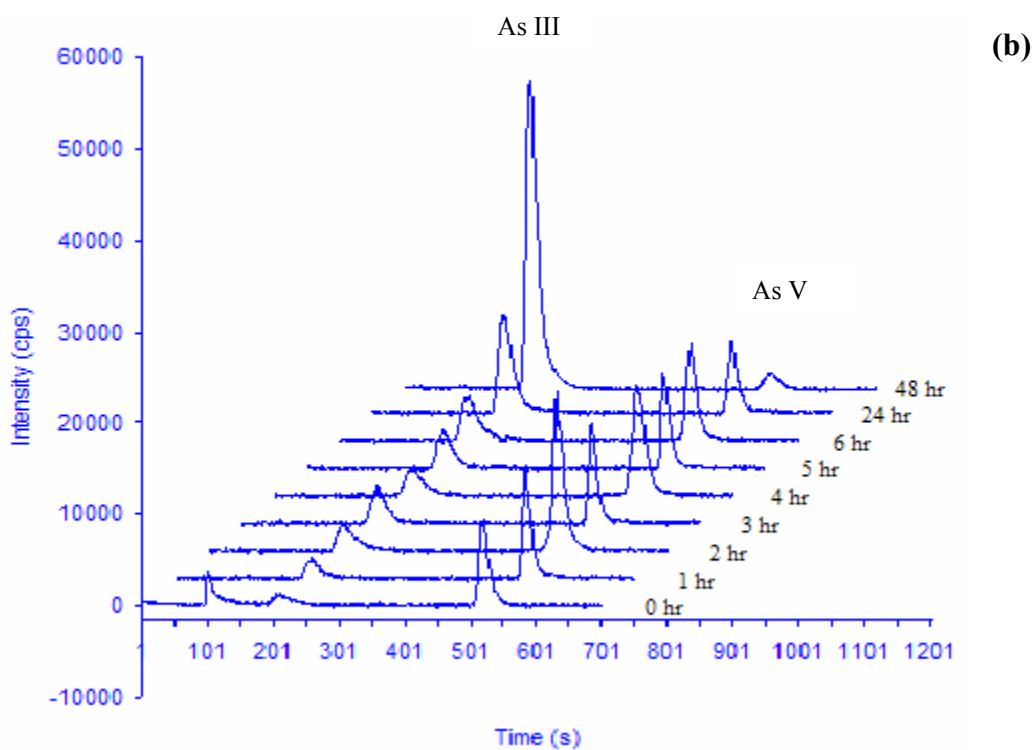
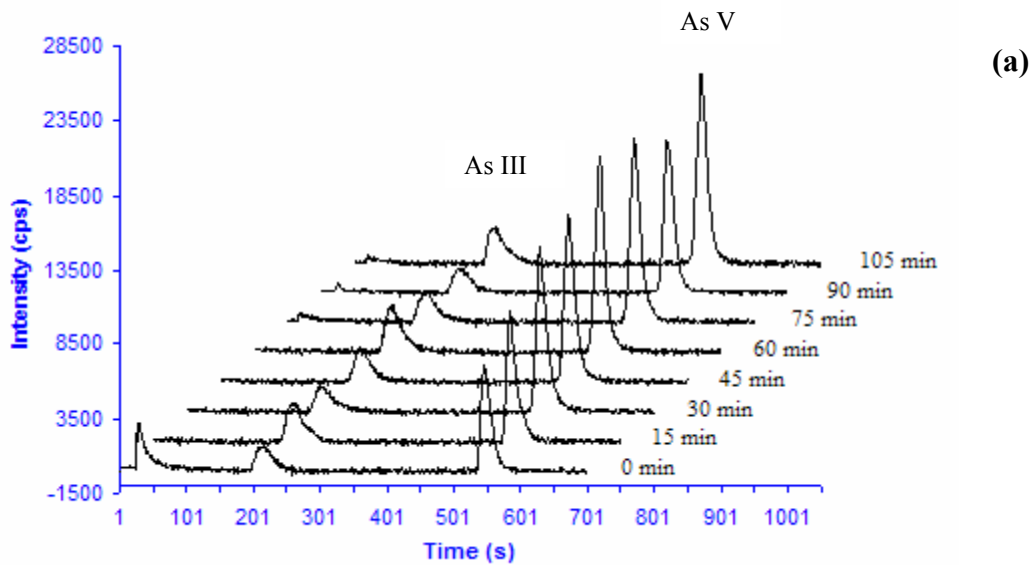


**Figure 3.9:** Chromatograms of different concentrations of AsB, DMA, and As(V) in deionized water.

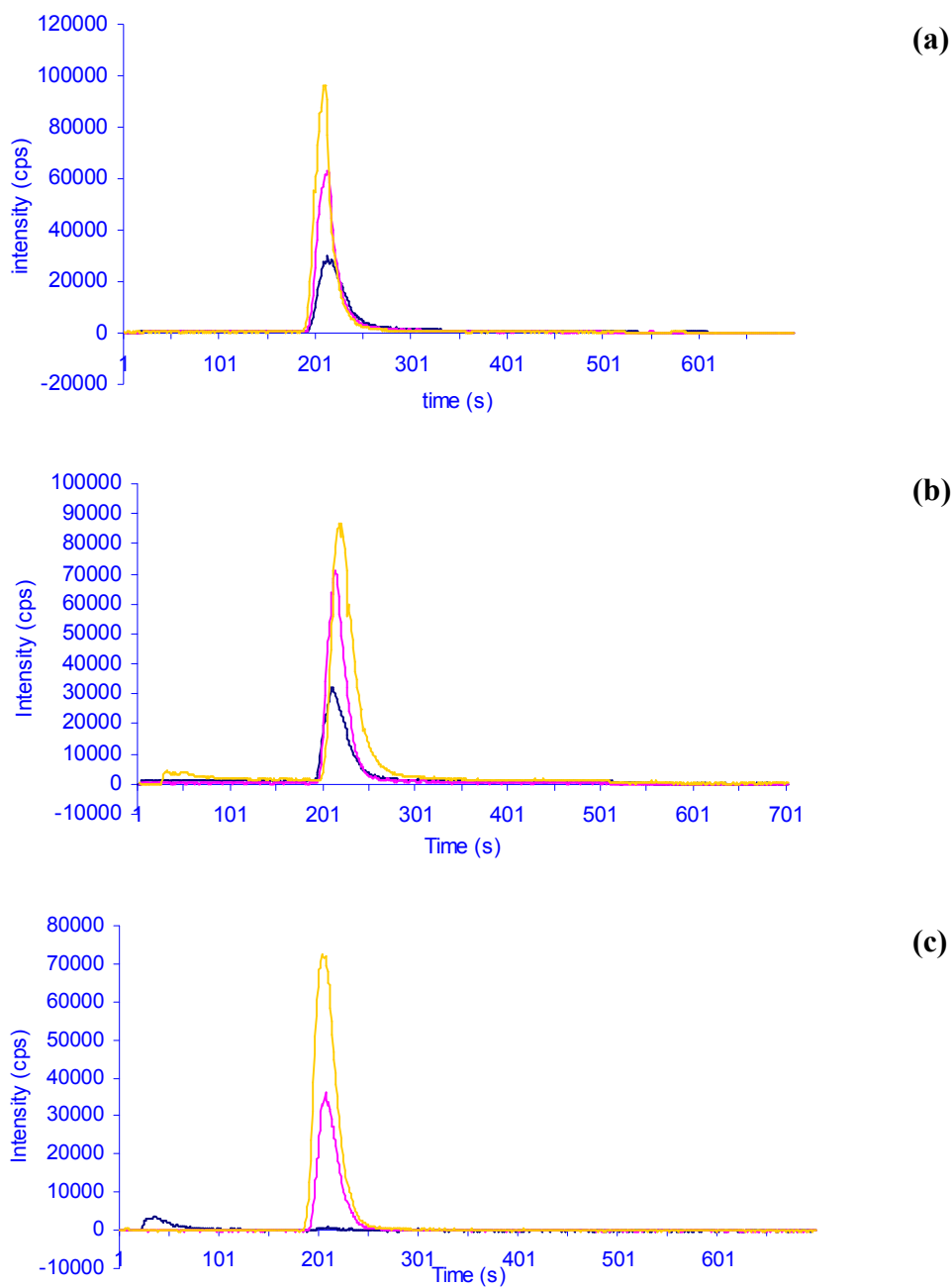




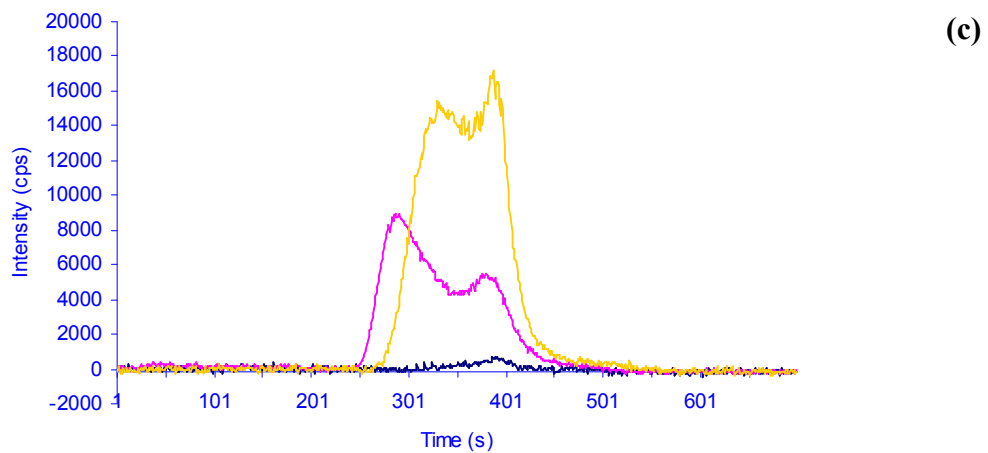
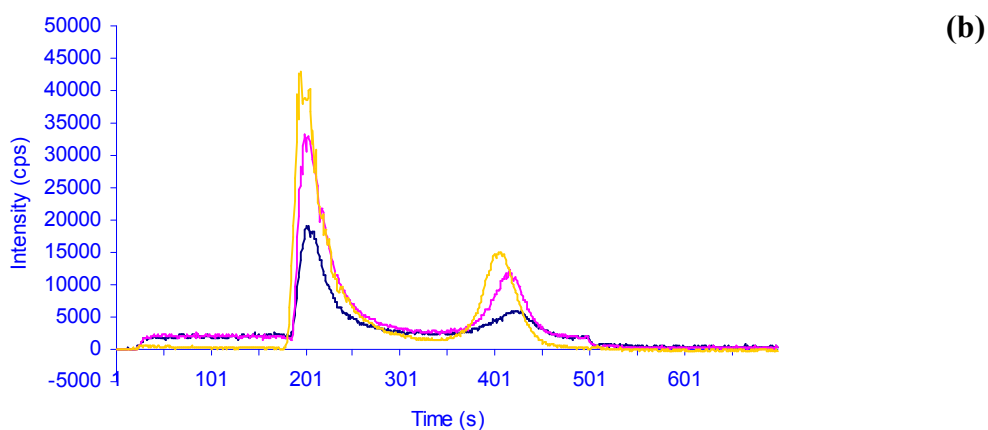
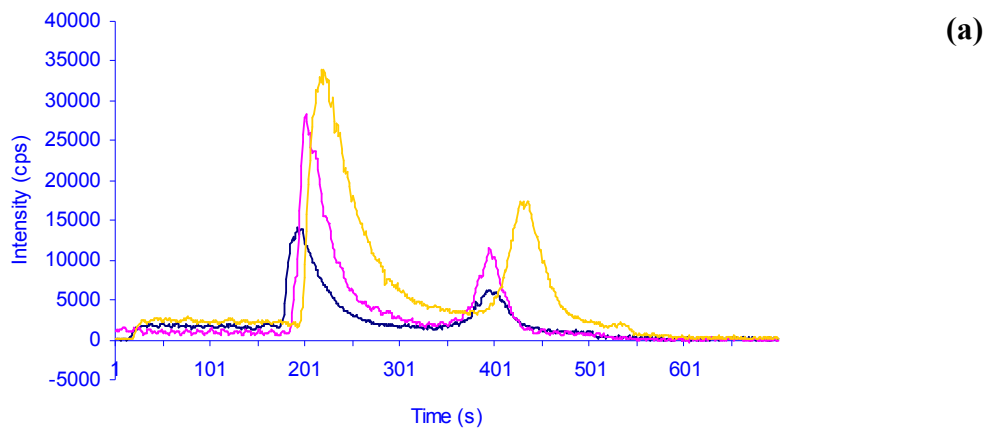
**Figure 3.10:** Chromatograms of (a) different concentration of AsB, DMA, and As(V) in MH media, and (b) of DMA and AsB; the DMA signal overlaps that of the AsB.



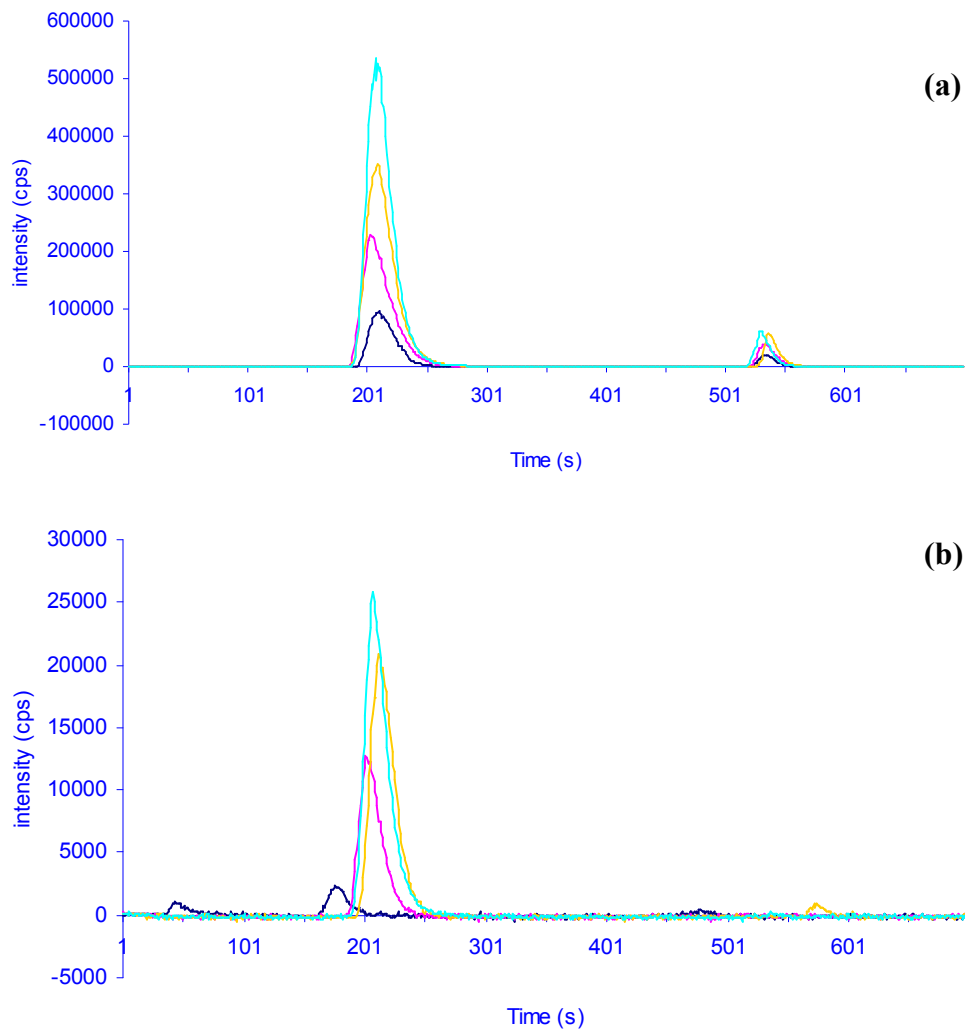
**Figure 3.11:** Chromatograms of As(V) metabolism by *E. coli* over (a) a 2 hour time period, at 15 minutes intervals and (b) over a 48 hour time period at one-hour intervals for the first 6 hours.



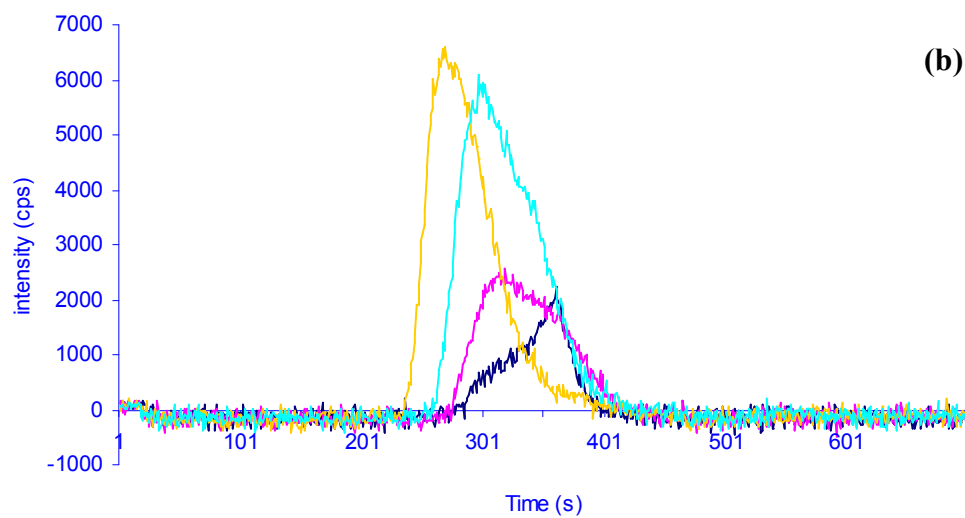
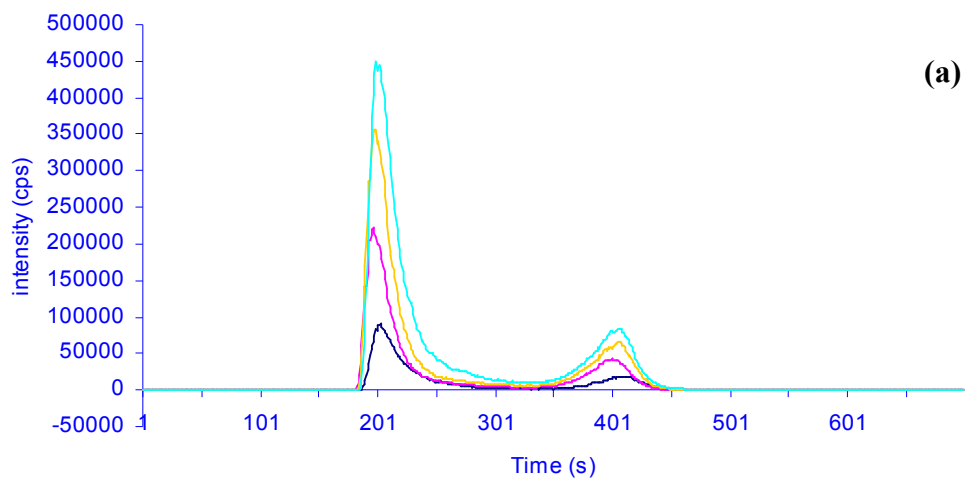
**Figure 3.12:** Chromatograms of As(III) extracted from different stages of the investigation. In (a), 1 ppm of As(III) in MH after 24 hours incubation without cells, as a control, then before analysis 0, 125 and 250 ppb of As(III) were added for standard addition analysis. Standard addition were also applied to (b) As(III) from MH after 24 hours incubation with cells, and (c) As(III) extracted from the cells using water and sonication overnight.



**Figure 3.13:** Chromatograms of DMA extracted from different stages of the investigation. In (a), 1 ppm of DMA in MH after 24 hours incubation without cells, as a control, then before analysis 0, 125 and 250 ppb of DMA were added for standard addition analysis. Standard addition were also applied to (b) DMA from MH after 24 hours incubation with cells, and (c) DMA extracted from the cells using water and sonication overnight.



**Figure 3.14:** Chromatograms of *E. coli* (a) grown in media contaminated with As(III) at concentrations ranging from 2.5 to 10 ppm and (b) then extracted with water and sonication overnight.



**Figure 3.15:** Chromatograms of *E. coli* grown in media contaminated with DMA at concentrations ranging from 2.5 to 10 ppm, (a) MH media analysis and (b) extracted with water.

### 3.5 References

- (1) Leermakers, M., Baeyens, W., De Gieter, M., Smedts, B., Meert, C., De Bisschop, H.C., Morabito, R., Quevauviller, Ph. *Trends Anal. Chem.* **2005**, *25*, 1-10.
- (2) Mato-Fernández, M.J., Otero-Rey, J.R., Moreda-Piñeiro, J., Alonso-Rodríguez, E., López-Mahía, P., Muniategui-Lorenzp, S., Prada-Rodríguez, D. *Talanta* **2007**, *70*, 515-520.
- (3) Jenkins, R., Ritchie, A., Edmonds, J., Goessler, W., Molenat, N., Kuehnelt, D., Harrington, C., Sutton, P. *Arch. Microbiol.* **2003**, *180*, 142-150.
- (4) Jenkins, R., Ritchie, A., Edmonds, J., Goessler, W. *FEMS Microbiol. Lett.* **2004**, *235*, 95-99.
- (5) U.S. Department of Health and Human Services: Agency for Toxic Substances and Disease Registry Division of Toxicology and Environmental Medicine. Arsenic Toxicity. **2000**.  
<http://www.atsdr.cdc.gov/HEC/CSEM/arsenic/docs/arsenic.pdf>, (accessed date 12/02/05).
- (6) Kuroda, K., Yoshida, K., Yoshimura, M., Endo, Y., Wanibuchi, H., Fukushima, S., Endo, G. *Toxicol. Appl. Pharmacol.* **2004**, *198*, 345-353.
- (7) Chakraborti, D., Chatterjee, A., Das, D., Mandal, B., Chowdhury, T., Samanta, G. *Analyst* **1995**, *120*, 643-650.
- (8) Ronkart, S., Laurent, V., Carbonnell, P., Mabon, N., Copin, A., and Barthélemy, JP. *Chemos.* **2007**, *66*, 738-745.
- (9) Al-Assaf, K.H. Determination of Arsenic Species in Environmental Samples. Doctor of Philosophy Dissertation, University of Massachusetts, Amherst, MA, February 2007.

## CHAPTER 4

### CONCLUSIONS AND FUTURE WORK

#### 4.1 Conclusions

##### 4.1.1 Solid Phase Extraction

Solid phase extraction is a simple, cost effective and reliable method for arsenic speciation. At pH 5.6, the strong cation-exchange column retained DMA and strong anion-exchange column retained As(V) and MMA. MMA could then be eluted by acetic acid, and DMA and As(V) could be eluted by nitric acid. The separated analytes could then be quantified by various spectrometry techniques. This method yielded close to 100% recovery consistently. Solid phase extraction also allows for pre-concentration of the analyte to a detectable amount when concentrations of arsenic in the sample were lower than the detection limit. When the method developed was applied to natural, instead of deionized, water, some slight adjustments were necessary because the arsenic concentration in the University's campus pond was too low to be detected. The alterations included methods such as spiked recovery and pre-concentration in order to overcome the matrix effect of the pond water and the problem with the detection limit.

Based on the flow rate optimization studies,  $3 \text{ mL min}^{-1}$  was the fastest sample introduction rate that yielded the most consistent results. Thus, the flow rate of  $3 \text{ mL min}^{-1}$  was used as the sample introduction rate for all of the investigations involving solid phase extraction.

The University of Massachusetts' campus pond water was speciated and analyzed for the presence of arsenic based on the methods developed for speciation of arsenic in



deionized water. Pre-concentration and speciation by solid phase extraction coupled to hydride generation atomic absorption spectrometry indicated that the pond water contained about 1 ppb of As(V), DMA and MMA combined.

Although the method developed was suitable for the water samples, including pond water, when the matrix was changed to Mueller-Hinton broth, it reacted with the solid phase of the column, competing with the analytes. This interference from the broth caused inconsistency in the results. Thus, a new method was developed to speciate arsenic species in MH broth.

#### **4.1.2 High Performance Liquid Chromatography**

In order to speciate arsenic in MH broth, a method was developed based on separation by anion-exchange chromatography coupled to ICP-OES. With anion-exchange chromatography at pH 5.6, As(III) and AsB were not retained in the column and were eluted with the void volume. DMA was the third most positive species and was the next to elute, followed by As(V), which is the least positive of all the species investigated. Arsenite and As(V) exhibited similar chromatographic behavior in water and MH broth matrices. On the other hand, DMA yielded a split peak when MH broth was present in the matrix, but the peak areas in the presence and absence of the broth were similar. The pH and concentration of the broth did not affect the retention behavior of DMA significantly. When the pH was decreased, the split peaks moved slightly closer together but still remained distinct. Similarly, when the concentration of the broth was diluted with deionized water, the retention times of the peaks changed slightly, but the split peak still remained. The media caused the bulk of DMA to elute faster than in a water matrix alone and the remainder of the analyte to elute at later time. When the

media was diluted with water, the retention time of DMA increased. Arsenic has been known to react with iron and thiol groups, both of which are present in the media. The retention behavior of DMA suggested that the shorter retention time was a result of DMA reacting with the media to form a more positive complex.

#### **4.1.3 Hydride Generation**

Hydride generation proved to be a very effective method of enhancing the arsenic ICP-OES signal. The peaks in chromatograms obtained with post-column hydride generation had increased intensity compared with those obtained in the absence of hydride generation (i.e. by direct nebulization). The peak area for 1 ppm DMA with hydride generation was close to 30 times greater (800,000 counts, compared with just 27,000 counts). Without hydride generation the peak area was very similar to that of AsB, a non-hydride reactive species. Direct nebulization also showed that various species at the same concentration of arsenic yielded about the same signal intensity, though on the application of statistical tests to the slopes showed that the compounds fell into two groups: AsB, DMA and As(V), and MMA and As(III). Although both As(III) and AsB were not retained in the column and were eluted simultaneously, As(III) was hydride reactive and yielded a very large peak at the solvent front. AsB, on the contrary, did not and so the first peak was interpreted as As(III).

#### **4.1.4 Intensities of Various Arsenic Species**

A preliminary investigation was conducted regarding the sensitivities, in counts per seconds per ppb, of the various arsenic species when measured by inductively coupled plasma – optical emission spectrometry, to investigate whether they are the

same, as shown in Figure 3.4. As a result of F-test and t-tests at 95% confidence, the sensitivities for AsB, DMA and As(V) were considered to be the same, however, the sensitivities for MMA and As(III) were considered to be statistically the same but were from a different distribution than were AsB, DMA and As(V).

This is considered to be due to each species' ease in forming molecular compounds. Some species would form more molecular species than others, resulting in lowered measurements of atomic emissions. In order to further investigate the effect, the molecular emissions of the analytes could be measure along with the atomic emissions.

#### **4.1.5 Biosynthesis of Arsenic Compounds by *E. coli***

Contrary to the popular belief that *E. coli* methylates inorganic arsenic to form the less toxic organic arsenic species, the investigations conducted suggested that there was no evidence that the *E. coli* cells had methylated the inorganic arsenic species to a less toxic organic species as a detoxification process. Instead, the bacteria reduced the As(V), which entered the cells via the phosphate uptake system, to As(III), the more toxic form, before removing the toxins from their systems via As(III) transporters. This process was not completely effective because at high concentrations of arsenic, the cells were not capable of maintaining such a gradient; as a result, arsenic was also present at a high concentration inside the cells.

According to Kuroda, et al,<sup>1</sup> when present in an arsenic-contaminated environment, *E. coli* synthesized several unknown species of arsenic, currently named M-1, M-2, and M-3, especially when high concentration of DMA was present in the same environment as sulfur. The results obtained from the investigations reported in this thesis do not agree with this previous finding. The results obtained were inconclusive to

whether a different species of arsenic was formed. The chromatograms of various separations contain only the species of arsenic present originally, no new peaks were detected. Though for a new species to be detected, it would have to be hydride active. This suggests that further work should be devoted to the determination of arsenic species by direct nebulization of the chromatographic eluent, so that compounds which are not hydride active can be detected. This is discussed further in the next section. The cell extracts were also analyzed for the presence of transformed arsenic species, but the chromatograms did not contain any unidentified peaks. When *E. coli* was present in As(V) contaminated media, the bacteria reduced the arsenic species to As(III) as a detoxification process. The media analysis suggests that in conditions with sufficient nutrients, the bacteria will be able to reduce all of the As(V) present to As(III).

## **4.2 Future Work**

### **4.2.1 Generating Hydride Reactive Species**

Although hydride generation enhances the intensities of the signals significantly, not all species of arsenic are hydride reactive. Photo-oxidation or microwave digestion could be applied to non-hydride reactive arsenic species, such as AsB and AC. Both of these methods are reliable and efficient decomposition procedures.<sup>1</sup> They would allow for the generation of volatile hydride species, which could then be detected. An extra step will allow for quantification of AsB at concentrations lower than 1.0 ppm. The concentrations of arsenic in the samples typically get diluted with the HPLC mobile phase. An alternative to hydride generation is detection of arsenic species by mass spectrometry. This method, although suffering from an isobaric interference (from  $^{40}\text{Ar}^{35}\text{Cl}^+$  vs. monoisotopic  $^{75}\text{As}^+$ ) and signal depression from salt, will still allow for

quantitative analysis of arsenic concentration, especially if an instrument with a dynamic reaction cell can be used

#### **4.2.2 HPLC Columns**

For a more detailed investigation, a different LC column could be used to separate As(III) from AsB. On an anion-exchange column, these two species exhibit similar retention behavior. However, a non-polar column such as C30 (using 1-butanefulfonic acid and tetramethylammonium hydroxide as ion pairing agents), reverse phase HPLC coupled to mass spectrometry, would allow for such separation in the absence of hydride generation, and at the same time, yield a more accurate quantification of each species, as demonstrated by Morita, et al. in a recent study of the simultaneous speciation of arsenic.<sup>2</sup> The investigation conducted, shown in Figure 2.7, suggests that a non-polar column will not retain the arsenic species well; however, the use of ion-pairing agents will help significantly.

#### **4.2.3 Growth Media**

Mueller-Hinton broth is one of many growth media used for growing and maintaining cell cultures. Although MH broth affected the retention behavior of DMA, other species of arsenic were not affected. Several other media, including the widely used Luria-Bertani (LB) broth, could be tested for their effects on the various arsenic species studied in this investigation. MMA, like DMA, both are methylated arsenic species, and thus have very similar structures. Mueller-Hinton broth may also affect the retention behavior of the analyte, as in the case of DMA. Many studies could be conducted to verify the effect of MH broth on DMA. Because DMA is known to react

well in the presence of sulfur, the reactivity of DMA to thiol groups and iron could be investigated. Also each component of the broth could be analyzed and react with DMA to better understand the chemical interaction between the broth and DMA.

#### **4.2.4 Different Models**

*E. coli* is only one of the models for living organisms, and the investigation could be expanded and involve many other organisms including different bacteria, archaea, and fungi cultures, such as *Leptospirillum ferriphilum*,<sup>3</sup> or *Bacillus indicus*,<sup>4</sup> both arsenic resistant bacteria, *Ferroplasma acidiphilum*,<sup>5</sup> an archaea, and *Saccharomyces cerevisiae*, also known as yeast, respectively. This would allow better understanding of how toxins, such as arsenic, are handled within multi-cellular organisms.

The arsenic detoxification processes undergone by living organisms are still not well understood. The studies performed suggested that the bacteria reduced As(V) as a means of detoxification, but no evidence of methylation of any arsenic species was observed. By altering some of the factors of the investigations, such as the instrumentation, or the separation techniques, the biological processes undergone by the bacteria could be better understood.

### 4.3 References

- (1) Mato-Fernández, M.J., Otero-Rey, J.R., Moreda-Piñeiro, J., Alonso-Rodríguez, E., López-Mahía, P., Muniategui-Lorenzo, S., Prada-Rodríguez, D. *Talanta* **2007**, *70*, 515-520.
- (2) Morita, Y., Kobayashi, T., Kuroiwa, T., and Narukawa, T. *Talanta* **2007**, *Article in Press*.
- (3) Tuffin, I.M., Hector, S.B., Deane, S.M., and Rawlings, D.E. *Appl. Environ. Microbiol.* **2006**, *72*, 2247-2253.
- (4) Suresh, K., Prabakaran, S.R., Sengupta, S., and Shivaji, S. *Int. J. Syst. Evol. Microbiol.* **2004**, *54*, 1369-1375.
- (5) Golyshina, O.V., and Timmis, K.N. *Environ. Microbiol.* **2005**, *7*, 1277-1288.

## BIBLIOGRAPHY

- Adriano, D., Page, A., Elsewi, A., Chang, A. and Starughan, I. *Environ. Qual.* **1980**, *9*, 323.
- Al-Assaf, K.H. Determination of Arsenic Species in Environmental Samples. Doctor of Philosophy Dissertation, University of Massachusetts, Amherst, MA, February 2007.
- Alberts, B., Johnson, A., Lewis, J., Raff, M., Roberts, K., and Walter, P. *Molecular Biology of the Cell*. Fourth Edition. Garland Science, New York, NY. 2002.
- Agency for Toxic Substances and Disease Registry (ATSDR). *U.S. Department of Public Health and Human Services, Public Health Service*. Georgia, 2005.
- Antony, P.J., Karthikeyan, S., Iyer, C.S.P. *Chromatography B.* **2002**, *767*, 363-368.
- Cai, Q., Yu, C., Guo, Z., Yang, Z., Khoo, S.B. *Spectrochim. Acta Part B.* **2003**, *58*, 1335-1349.
- Chakraborti, D., Chatterjee, A., Das, D., Mandal, B., Chowdhury, T., Samanta, G. *Analyst* **1995**, *120*, 643-650.
- Christen, K. *Environ Sci. Technol.* **2001**, *35*, 184A.
- Cullen, W., and Reimer, K. *Chem. Rev.* **1989**, *89*, 713-764.
- Czarnecki, D., and Baker, G. *Poultry Sci.* **1982**, *61*, 516.
- Fulladosa, E., Murat, J.C., Bollinger, J.C., Villaescusa, I. *Sci. Total Environ.* **2007**, *Article in Press*.
- Golyshina, O.V., and Timmis, K.N. *Environ. Microbiol.* **2005**, *7*, 1277-1288.
- Jenkins, R., Ritchie, A., Edmonds, J., Goessler, W., Molenat, N., Kuehnelt, D., Harrington, C., Sutton, P. *Arch. Microbiol.* **2003**, *180*, 142-150.
- Jenkins, R., Ritchie, A., Edmonds, J., Goessler, W. *FEMS Microbiol. Lett.* **2004**, *235*, 95-99.
- Kaltreider, R., Davis, A., Lariviere, J., and Hamilton, J. *Environ. Health Perspect.* **2001**, *109*, 245-251.
- Kuroda, K., Yoshida, K., Yoshimura, M., Endo, Y., Wanibuchi, H., Fukushima, S., Endo, G. *Toxicol. Appl. Pharmacol.* **2004**, *198*, 345-353.



- Leermakers, M., Baeyens, W., De Gieter, M., Smedts, B., Meert, C., De Bisschop, H.C., Morabito, R., Quevauviller, Ph. *Trends Anal. Chem.* **2005**, *25*, 1-10.
- Lindberg, A., Goessler, W., Grandér, M., Nermell, b., and Vahter, M. *Toxicol. Lett.* **2007**, *168*, 310-18.
- Mandal, B., and Suzuki, K. *Talanta.* **2002**, *508*, 201-235.
- Mato-Fernández, M.J., Otero-Rey, J.R., Moreda-Piñeiro, J., Alonso-Rodríguez, E., López-Mahía, P., Muniategui-Lorenzp, S., Prada-Rodríguez, D. *Talanta* **2007**, *70*, 515-520.
- Morrison, J. *J. Ag. Food Chem.* **1969**, *39*, 146.
- Morita, Y., Kobayashi, T., Kuroiwa, T., and Narukawa, T. *Talanta* **2007**, *Article in Press*.
- National Research Council. *Arsenic*; National Academy of Sciences: Washington, DC, 1977, 16.
- National Research Council. *Arsenic in Drinking Water*. National Academy Press, Washington, D.C. 1999.
- Office of Ground Water and Drinking Water (OGWDW). *U.S. Environmental Protection Agency*. Washington, D.C. 2006.
- Oremland, R., and Stolz, J. *Science.* **2003**, *300*, 939-944.
- Petrick, J., Ayala-Fierro, F., Cullen, W., Carter, D., and Aposhian, HV. *Toxicol. Appl. Pharmacol.* **2000**, *163*, 203-207.
- Pott, W., Benjamin, S., and Yang, R. *Rev. Environ. Contam. Toxicol.* **2001**, *169*, 165.
- Prohaska, T., Pfeffer, M., Tulipan, M., Stingeder, G., Mentler, A. and Wenzel, W. *Fresenius J. Anal. Chem.* **1999**, *52*, 583.
- Ronkart, S., Laurent, V., Carbonnell, P., Mabon, N., Copin, A., and Barthélemy, JP. *Chemos.* **2007**, *66*, 738-745.
- Rosen, B. Metals in Biology: Past, Present and Future. *Molecular Biology of Metal Homeostasis and Detoxification: From Microbes to Man*, 1<sup>st</sup> edition; Topics in Current Genetics; Springer: Berlin, 2006; *14*, 485-505.
- Suresh, K., Prabakaran, S.R., Sengupta, S., and Shivaji, S. *Int. J. Syst. Evol. Microbiol.* **2004**, *54*, 1369-1375.

- Takeuchi, M., Kawahata, H., Gupta, L.P., Kita, N., Morishita, Y., Ono, Y., Komai, T. *J. Biotechnol.* **2007**, *127*, 434-442.
- Thomaidis, N., Schaeffer, R., Soeroes, C., Ipolyi, I., Fodor, P. *Anal. Chim. Acta.* **2005**, *547*, 109-118.
- Tuffin, I.M., Hector, S.B., Deane, S.M., and Rawlings, D.E. *Appl. Environ. Microbiol.* **2006**, *72*, 2247-2253.
- U.S. Department of Health and Human Services: Agency for Toxic Substances and Disease Registry Division of Toxicology and Environmental Medicine. Arsenic Toxicity. 2000.  
<http://www.atsdr.cdc.gov/HEC/CSEM/arsenic/docs/arsenic.pdf>, (accessed date 12/02/05).
- van Elteren, J.T., Stibilj, V., and Šlejkovec, Z. *Water Res.* **2002**, *36*, 2967-2974.
- Welch, A., Westjohn, D., Helsel, S., and Wanty, R. *Groundwater.* **2000**, *13*, 589.
- The World Health Organization: Arsenic in drinking water. 2001.  
<http://www.who.int/mediacentre/factsheets/fs210/en/>. (Date accessed: 4.22.07).
- Wrobel, K., Wrobel, K., Sasi, P., Kannamkumarath, S., and Caruso, J. *Talanta* **2002**, *58*, 899-907.
- Yu, C., Cai, Q., Guo, Z., Yang, Z., and Khoo, S. *Spectrochim Acta Part B.* **2003**, *58*, 1335-1349.