

9-2009

# On the Discrete Differential Geometry of Surfaces in $S^4$

George Shapiro

University of Massachusetts Amherst, geoshapiro@gmail.com

Follow this and additional works at: [https://scholarworks.umass.edu/open\\_access\\_dissertations](https://scholarworks.umass.edu/open_access_dissertations)



Part of the [Mathematics Commons](#)

---

## Recommended Citation

Shapiro, George, "On the Discrete Differential Geometry of Surfaces in  $S^4$ " (2009). *Open Access Dissertations*. 135.  
[https://scholarworks.umass.edu/open\\_access\\_dissertations/135](https://scholarworks.umass.edu/open_access_dissertations/135)

This Open Access Dissertation is brought to you for free and open access by ScholarWorks@UMass Amherst. It has been accepted for inclusion in Open Access Dissertations by an authorized administrator of ScholarWorks@UMass Amherst. For more information, please contact [scholarworks@library.umass.edu](mailto:scholarworks@library.umass.edu).

ON THE DISCRETE DIFFERENTIAL GEOMETRY OF SURFACES IN  $S^4$

A Dissertation Presented

by

GEORGE SHAPIRO

Submitted to the Graduate School of the  
University of Massachusetts Amherst in partial fulfillment  
of the requirements for the degree of

DOCTOR OF PHILOSOPHY

September 2009

Department of Mathematics and Statistics

© Copyright by George Shapiro 2009

All Rights Reserved

ON THE DISCRETE DIFFERENTIAL GEOMETRY OF SURFACES IN  $S^4$

A Dissertation Presented

by

GEORGE SHAPIRO

Approved as to style and content by:

---

Franz Pedit, Chair

---

Rob Kusner, Member

---

Peter Norman, Member

---

David Kastor (Physics), Member

---

George Avrunin, Department Head  
Mathematics and Statistics

## Dedication

to Max & Fedya.

## ACKNOWLEDGEMENTS

Thank-you, Peter Skiff.

# ABSTRACT

ON THE DISCRETE DIFFERENTIAL GEOMETRY OF SURFACES IN  $S^4$

SEPTEMBER 2009

GEORGE SHAPIRO, B.A., BARD COLLEGE

M.A., UNIVERSITY OF MASSACHUSETTS AMHERST

PH.D., UNIVERSITY OF MASSACHUSETTS AMHERST

Directed by: Professor Franz Pedit

The Grassmannian space  $G_c(2, 4)$  embedded in  $\mathbb{CP}^5$  as the Klein quadric of twistor theory has a natural interpretation in terms of the geometry of “round” 2-spheres in  $S^4$ . The incidence of two lines in  $\mathbb{CP}^3$  corresponds to the contact properties of two 2-spheres, where contact is generalized from tangency to include “half-tangency:” 2-spheres may be in contact at two isolated points. There is a connection between the contact properties of 2-spheres and soliton geometry through the classical Ribaucour and Darboux transformations. The transformation theory of surfaces in  $S^4$  is investigated using the recently developed theory of “Discrete Differential Geometry” with results leading to the conclusion that the discrete conformal maps into  $\mathbb{C}$  of Hertrich-Jeromin, McIntosh, Norman and Pedit may be defined in terms a discrete integrable system employing half-tangency in  $S^4$ .

# TABLE OF CONTENTS

	Page
ACKNOWLEDGEMENTS . . . . .	v
ABSTRACT . . . . .	vi
LIST OF FIGURES . . . . .	viii
CHAPTER	
1. INTRODUCTION . . . . .	1
2. PROJECTIVE GEOMETRY . . . . .	7
2.1 Incidence geometry in three-dimensional projective space. . . . .	7
2.2 The Klein Quadric . . . . .	10
2.2.1 The incidence geometry of lines in the Klein quadric . . . . .	14
2.2.2 $S^4$ defined by a real structure on the Klein Quadric . . . . .	19
2.3 Spheres and $\mathbb{HP}^1$ . . . . .	23
2.3.1 Tangency of oriented 2-spheres in $\mathbb{HP}^1$ . . . . .	27
2.3.2 Circles in $S^4$ . . . . .	34
2.4 The contact geometry of the Klein quadric . . . . .	44
2.5 $S^3$ Considered as a Subset of $S^4$ . . . . .	51
2.5.1 Quaternionic Hermitian forms . . . . .	51
2.5.2 The line-sphere correspondence of Lie . . . . .	57
2.5.3 Circles in $S^3$ . . . . .	62
3. DISCRETE DIFFERENTIAL GEOMETRY . . . . .	64
3.1 Philosophy . . . . .	64
3.2 A little naive quaternionic surface theory. . . . .	64
3.3 Planar nets . . . . .	68
3.4 Discrete nets in quadrics . . . . .	75
3.4.1 Real reduction of the planar quadric net . . . . .	82
3.4.2 Real quadric planar nets in $S^2$ : circles . . . . .	84
3.4.3 Real cross-ratio system. . . . .	87
3.4.4 Extending the real cross-ratio system to $\mathbb{Z}^3$ . . . . .	89
3.4.5 The complex cross-ratio system . . . . .	91
BIBLIOGRAPHY . . . . .	96



## LIST OF FIGURES

Figure	Page
1. Three cases: generic, half-touching, touching . . . . .	3
2. Discrete curvature line directions. . . . .	5
3. Point, Line, and Plane . . . . .	8
4. Duality and incidence properties of lines and planes. . . . .	10
5. Correspondence between planar pencil in $\mathbb{CP}^3$ and line in $Kl$ . . . . .	16
6. Five configurations and four induced ranks. . . . .	16
7. Three configurations and two induced ranks. . . . .	17
8. A line $\sigma$ and the image of that line $\sigma j$ . . . . .	24
9. Two 2-spheres tangent at the twistor fiber $L$ . . . . .	31
10. Three Points and Incident 2-Sphere . . . . .	35
11. Construction of a fourth point using the Steiner cross-ratio. . . . .	42
12. Given the point $p$ and sphere $S$ , there is a unique sphere $S_i$ through $q$ and incident to $S$ . . . . .	46
13. Intersection of four 2-spheres at two points, $r$ and $q$ . . . . .	50
14. Three points on $S$ . . . . .	51
15. A complex pencil of spheres tangent at $f(p)$ . . . . .	67
16. A planar quadrilateral net . . . . .	69
17. The elementary hexahedron. . . . .	71
18. The elementary 4-dimensional “cube.” . . . . .	73
19. Discrete Bianchi permutability. . . . .	75
20. Cross-ratios and orientations. . . . .	81
21. Initial value problem for circular nets. . . . .	88
22. Miquel configuration of circles. . . . .	90

23. Cross-ratio constraint for zero-curvature representation. . . . .	92
24. Non-real Steiner cross-ratio of four points in $Q_S \subset Kl$ . . . . .	93
25. A question. . . . .	95

# CHAPTER 1

## INTRODUCTION

The first part of this project is an attempt to develop some of the elementary geometrical theory of 2-spheres in  $S^4$ . There are many problems in classical geometry such as Apollonius's Problem: to construct circles that are tangent to three given circles in a plane. It was the subject of Sophus Lie's dissertation to develop tools of "analytical geometry" in order to solve these problems involving the contact of circles and spheres. He showed that the space of hyperspheres in space may be completed by including points and hyperplanes to form a quadric projective variety: in the case of the problem of Apollonius, the space of circles in  $S^2$ . In the Lie quadric, two hyperspheres are tangent if their representatives are orthogonal with respect to the "absolute quadratic form" of the quadric variety (it is worth noting that the space of lines in the Lie quadric is a "contact manifold" in the modern sense.) Thus, the problem of Apollonius is solved by computing the orthogonal space with respect to three points in the absolute quadric corresponding to the three given circles: the quadric is three-dimensional so the orthogonal space consists of the two points corresponding to the orientations of a single circle. Purely geometrical problems are thus reduced to calculations in algebraic geometry.

The early work of Lie in geometry was a continuation of the work of Plücker and Klein. The Plücker quadric is the Grassmanian space  $G_{\mathbb{R}}(2, 4)$  or, the space of projective lines in  $\mathbb{R}P^3$ . One of the achievements of Lie in 19th century geometry was his "line-sphere" correspondence [23] which showed that one could map a subset of the space of spheres in  $\mathbb{R}^3$  into the Plücker quadric. The Lie quadric is a codimension one theory

that is, a theory of *hyperspheres*. 2-spheres in  $S^4$  are codimension two. The line-sphere correspondence is exact for the codimension two theory: the space of 2-spheres in  $S^4$  is equivalent to the space of *complex* projective lines in  $\mathbb{CP}^3$ . Following the literature of twistor theory, I will distinguish between  $G_{\mathbb{R}}(2, 4)$  and  $G_{\mathbb{C}}(2, 4)$  by referring to the latter as the *Klein quadric*.

It is well known in twistor theory that the Klein quadric is obtained by complexifying the Lie quadric [22] of 2-spheres in  $S^3$  where the Lie quadric is viewed as the conformal compactification of Minkowski space. In the Klein quadric, the Lie quadric is defined as the real set of a real structure defined by a choice of  $S^3 \subset S^4$ . Contact between 2-spheres in  $S^4$  is defined by orthogonality and is equivalent to the incidence of corresponding lines in  $\mathbb{CP}^3$ . However, orthogonality in the Klein quadric generalizes contact beyond tangency. In  $S^4$ , two-spheres may “half-touch” at two isolated points. In the quaternionic surface theory of Burstall, Ferus, Leschke, Pedit, and Pinkall[14] this condition is defined by the equality of induced complex structures on the tautological bundle and co-bundle at two points respectively. In the Klein quadric 2-spheres are represented by projective lines  $\mathbb{CP}^3$  and “half-touching” is generic condition on the incidence of two such lines in  $\mathbb{CP}^3$ . Orthogonal points in a quadric span null lines contained within the quadric. These null lines are called “contact lines:” in the Lie quadric they parameterize the family of hyperspheres tangent to a given hypersphere at a point with one real parameter. In the Klein quadric contact lines are parameterize the family of 2-spheres tangent to a given sphere at a point and the family of 2-spheres half-touching at two points with one complex parameter. Half-touching is a generic condition for the set of contact lines in the Klein quadric.

The classical Ribaucour transformation of an immersed surface  $f(\Sigma)$  parameterized by curvature lines in  $\mathbb{R}^3$  can be defined geometrically in terms of envelopes of sphere congruences: maps from  $\Sigma$  attaching to each point a two-sphere in  $\mathbb{R}^3$  which is tangent to  $\Sigma$  at this point [16]. If the envelope of this congruence is an immersed surface  $f^+(\Sigma)$

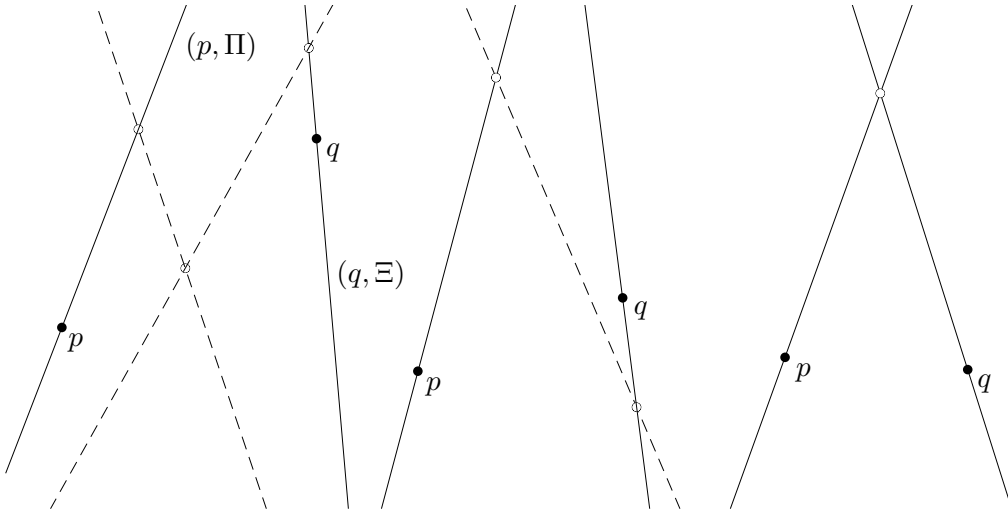

**Figure 1. Three cases: generic, half-touching, touching**

also parameterized by curvature lines then  $f \rightarrow f+$  is a Ribacour transformation. If  $\Sigma$  is considered as a Riemann surface and the curvature lines are conformal and similar for  $f^+(\Sigma)$ , then  $f \rightarrow f+$  is a Darboux transformation. It was the idea of Pinkall and Pedit [20] to generalize the Darboux transformation to surfaces in  $S^4$  by considering congruences between surfaces where the resulting spheres half-touch one surface and touch the other surface. This is naturally viewed, pointwise, in terms of contact lines in the Klein quadric. Imagine over corresponding points of two surfaces related by a congruence the two contact lines of the 2-spheres tangent at either point. Contact lines are defined by incidence of lines in  $\mathbb{CP}^3$ , hence they may also be defined by the  $(1, 3)$  flag consisting of the point of intersection and the projective plane defined by the incidence of two lines, the point naturally being contained in the plane. Two projective planes in  $\mathbb{CP}^3$  intersect in a line. Thus, there are three cases for the relationship between two contact lines represented by two  $(point, plane)$  pairs in  $\mathbb{CP}^3$ : generically, the line of intersection is incident to neither point, then the line of intersection may be incident to one point and, finally, both points might lie on the line of intersection. The last case corresponds to the classical Darboux transformation and the middle to the generalized Darboux transformation.

The second part of this project consists of an attempt to develop these ideas using

the new theory of “discrete differential geometry.” The modern theory of “discrete” differential geometry dates back to the work of Sauer in the 1950’s[5]. Recent work by Adam Doliwa [8] has linked Sauer’s foundation with the theory of integrable systems, employing a novel theory of discrete integrability and thus creating a discrete soliton geometry directly analogous to the smooth theory. However, the essential ideas of discrete differential geometry are really just the systematic development of classical “infinitesimal” constructions and part of the novelty stems from the obscurity of the original arguments. The focus is on local surface theory: parameterizations with special properties. An approach to global questions can be seen in the recent paper of Bobenko, Hoffmann and Springborn in the Annals of Math[6].

The success of discrete differential geometry in discretizing classical surface theory stems from the fact that curvature line coordinate parameterizations are a subset of solutions to the “conjugate net” or Laplace equations:

$$\partial_i \partial_j f = c_{ji} \partial_i f + c_{ij} \partial_j f, i \neq j.$$

Discretizing the Laplace equations leads to the consideration of discrete conjugate nets, maps from  $\mathbb{Z}^k \rightarrow \mathbb{RP}^n$ , with the property that the image of each two-dimensional face of  $\mathbb{Z}^k$  is planar in  $\mathbb{RP}^n$ [10]. Henceforth these discrete conjugate nets will be referred to as “planar quadrilateral nets.” Then, discrete curvature line coordinates are discretized by “reducing” planar quadrilateral nets by requiring the vertices to lie the  $n - 1$ -sphere as a quadric hypersurface in  $\mathbb{RP}^n$  [10]. This defines circular nets in  $R^{n-1}$  by stereographic projection. The curvature line directions are then seen in the orthogonal bisecting lines of the opposite vertices of each elementary face[2].

We show that these circular nets may be derived as a real reduction of complex planar nets whose vertices are constrained to lie in the Klein quadric. The concept of “real reduction” has not been discussed before in the literature. This reduction is determined by requiring the net to take values in the real set defined by the real structure induced on the Klein quadric by right multiplication by the quaternionic  $j$  on  $\mathbb{H}^2$  via the twistor

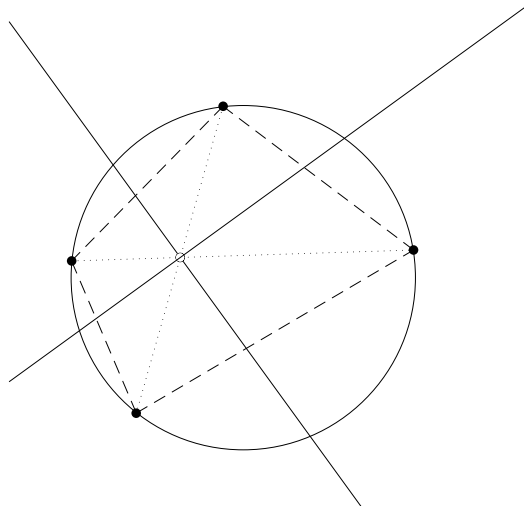

**Figure 2. Discrete curvature line directions.**

construction.

My main result concerns an interpretation of the "discrete conformal maps" of Hertrich-Jeromin, McIntosh, Norman and Pedit [15]. A discrete conformal map is defined to be a map from  $\mathbb{Z}^2 \rightarrow \mathbb{CP}^1$  with the property that the cross-ratio of the image of every elementary face of  $\mathbb{Z}^2$  takes a constant non-zero value. If that cross-ratio is real, then the vertices of that elementary face are contained in a circle, and so each face of the discrete conformal map defines a net of interlocking circles.

Discrete conformal maps were conceived as a simple example to study the connection between the "spectral curve" of a special immersed discrete surface (with constant cross ratio) and the resulting geometry. The spectral curve is obtained by considering periodic initial data on one axis of  $\mathbb{Z}^2$ . The resulting monodromy problem contains the cross-ratio as a spectral parameter. The invariance of the spectral curve over a discrete conformal map defined by the evolution of the initial data is derived from a zero-curvature representation of the equations defining the discrete conformal map. This evolution is considered to be a discretization of the Schwarzian KdV system. Now, in Discrete Differential Geometry the zero-curvature equation is an expression of a more basic discrete "integrability" or

“consistency” criterion[5].

For real values, discrete conformal nets correspond to circular nets and are thus a discretization of curvature line coordinates[1]. Circular nets may be defined in  $S^4$  by a quaternionic cross-ratio on  $\mathbb{HP}^1 \cong S^4$  where the quaternionic cross-ratio is defined in exactly the same fashion as  $\mathbb{CP}^1$ . Thus, circular nets in  $S^2$  may be defined as circular nets into  $S^2 \subset S^4$ . However, the quaternionic cross-ratio is not Möbius invariant for complex values and does not define unique Möbius transformations of  $S^4$ . Thus, there is no “complex” cross-ratio system in  $\mathbb{HP}^1$  directly analogous to discrete conformal maps into  $\mathbb{CP}^1$ . There is a zero-curvature representation for real cross-ratio (circular) nets in  $\mathbb{HP}^1$  and corresponding spectral problem[21], but only for real values of the spectral parameter.

We have obtained results which suggest that discrete conformal maps in  $S^2$  for complex cross-ratio may be defined by a “generalized isothermic lattice[7]“ in the Klein quadric defined by fixing a  $S^2 \subset S^4$ . Complex values of the cross-ratio correspond to discrete nets that include not just points in  $S^2$  but 2-spheres in  $S^4$  which half-touch the fixed  $S^2$  and thereby define discrete conformal maps. This suggests that extending the spectral problem in  $S^4$  to complex values of the spectral parameter involves moving to surfaces made of spheres, i.e. maps from  $\Sigma$  to the Klein quadric whose images contain points in the quadric corresponding to two-spheres in  $S^4$ .



## CHAPTER 2

### PROJECTIVE GEOMETRY

#### 2.1 Incidence geometry in three-dimensional projective space.

Projective geometry of a given dimension is modeled by the set of one dimensional subspaces of a given vector space with dimension one greater. So, three dimensional complex projective geometry is realized as the space of one-dimensional subspaces,  $\mathbb{P}(V)$ , in a four complex dimensional vector space  $V$ . Given such a model of projective geometry there is a canonical map  $P : V \rightarrow \mathbb{P}(V)$  defined by  $x \rightarrow x\mathbb{C} = [x]$ .

**Definition:** Let  $V$  be a vector space with  $\dim V = n$ . Then  $\mathbb{P}^{n-1} = \{l < V : \dim(l) = 1\}$  is  $n - 1$ -dimensional projective space, with map  $P : V \rightarrow \mathbb{P}^{n-1}$  given by  $x \rightarrow l$  such that  $x \in l$ .

The most primitive class of geometric relations could be defined as the intersection properties of sets of linear subspaces of  $V$  viewed in  $\mathbb{P}(V)$  : incidence geometry. By construction, incidence is preserved by projective maps (unless one allows singular projective maps by leaving the general linear group.)

As defined, a “point” in  $\mathbb{P}(V)$  is a one-dimensional subspace of a four dimensional complex vector space  $V$ . A “line” is a two-dimensional subspace of  $V$ . A “plane” is a three-dimensional subspace of  $V$ . There are two views of ‘incidence,’ for example, one could say, “two points span a line” or “there is exactly one line incident to two points,” the differences being between generation and existence. Then, there is the question of uniqueness.

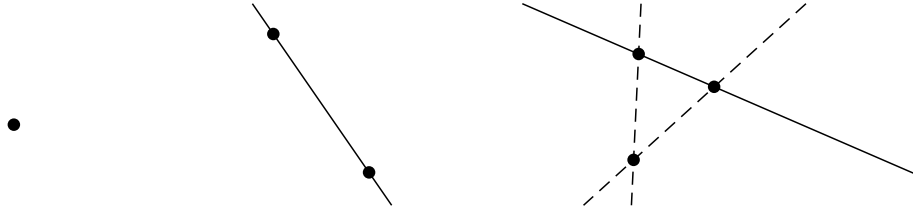

**Figure 3. Point, Line, and Plane**

**Lemma 2.1.1** *Two distinct points span exactly one line.*

**Proof.** Let  $p_1$  and  $p_2$  be two points in  $\mathbb{P}(V)$ . There exist vectors  $v_1$  and  $v_2 \in V \cong \mathbb{C}^4$  such that  $p_1 = \mathbb{C}v_1$  and  $p_2 = \mathbb{C}v_2$ . Thus  $p_1, p_2$  are contained in the projective line  $l = \mathbb{P}(\text{Span}\{v_1, v_2\})$ . Further, any line containing  $p_1$  and  $p_2$  will contain  $l$ . Thus the generation is unique. ■

I will say that two things are disjoint if they are not incident.

**Lemma 2.1.2** *Let  $l$  be a line and  $p$  a point in  $\mathbb{P}^3$  such that  $p$  is disjoint from  $l$ . Then,  $l$  and  $p$  are contained in exactly one plane.*

**Proof.** Let  $p = \mathbb{C}v_0$  and  $l = P(\text{Span}\{v_1, v_2\})$ . Since  $p$  and  $l$  are disjoint,  $\dim(\text{Span}\{v_0, v_1, v_2\}) = 3$ . Thus  $p$  and  $l$  are incident to the projective plane  $A = P(\text{Span}\{v_0, v_1, v_2\})$  and, as before,  $A$  is unique. ■

**Corollary 2.1.3** *Three points span exactly one plane provided they do not all lie on one line.*

Let  $V$  be a four dimensional complex vector space. Then  $V^* = \text{Hom}_{\mathbb{C}}(V, \mathbb{C})$  is a four dimensional vector space. Thus, one may consider the projective space  $\mathbb{P}(V^*)$ .  $\mathbb{P}(V^*)$  is a three dimensional projective space and so looks like any other, but there is a relationship between elements of  $\mathbb{P}(V)$  and elements of  $\mathbb{P}(V^*)$  :

**Lemma 2.1.4** *Let  $[\alpha]$  be a point in  $\mathbb{P}(V^*)$ , then  $[\alpha]^o = P(\{x \in V \text{ such that } \alpha(x) = 0\})$  is a projective plane. Given  $p = \mathbb{C}x \in \mathbb{P}(V)$ ,  $p^* = \mathbb{P}(\{\alpha \in V^* : \alpha(x) = 0\})$  is a projective plane in  $\mathbb{P}(V^*)$ .*

**Lemma 2.1.5** *For any linear object (point, line, plane)  $B \subset \mathbb{P}(V)$ ,  $B^{*o} = B$ .*

Without confusion one may say the following:

**Lemma 2.1.6** *Let  $A$  be a projective plane in  $\mathbb{P}(V)$  then  $A^*$  is a point in  $\mathbb{P}(V^*)$ . Given a projective plane  $\Pi$  in  $\mathbb{P}(V^*)$ ,  $\Pi^o$  is a point in  $\mathbb{P}(V)$ .*

**Lemma 2.1.7** *Let  $l$  be a projective line in  $\mathbb{P}(V)$  then  $l^*$  is a projective line in  $\mathbb{P}(V^*)$ . Given a projective line  $\lambda$  in  $\mathbb{P}(V^*)$ ,  $\lambda^o$  is a projective line in  $\mathbb{P}(V)$ .*

This relationship is called “duality” and one obtains new incidence relations by “dualizing” known ones:

**Lemma 2.1.8** *Two planes are incident to exactly one line*

**Lemma 2.1.9** *A plane and a line not contained in that plane are incident to exactly one point.*

**Corollary 2.1.10** *Three planes are incident to exactly one point provided they are not all incident to one line.*

Given a point  $p \in \mathbb{P}(V)$ , a plane incident to  $p$  has, as a dual image, a point in the projective plane  $p^* \subset \mathbb{P}(V^*)$ . So, the set of projectives planes incident to  $p$  maps by duality to the set of points in  $p^*$ . By duality this is a bijection. Note that the image of a projective line in  $\mathbb{P}(V)$  under duality is a projective line in  $\mathbb{P}(V^*)$ . One says that a subset of  $S \subset \mathbb{P}(V)$  is “self-dual” if  $S^* \subset \mathbb{P}(V^*)$  is the ‘same.’ Consider the set of all lines incident to  $p$ . The dualized image of this “sheaf” is the set of all lines in  $\mathbb{P}(V^*)$  incident to the projective plane  $p^*$ .

The set of lines contained in a plane is dual to the set of lines incident to the point which is the dual of the plane. Then the set of lines in a plane incident to a point in that plane is given by the intersection of the set of all lines in that plane with the set of lines through the point. Thus the following is obtained:

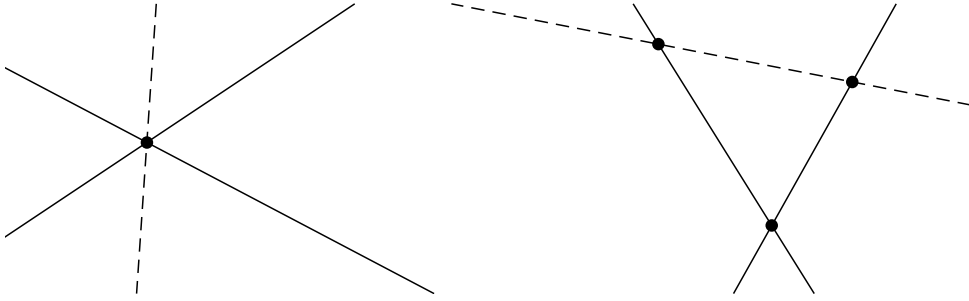

**Figure 4. Duality and incidence properties of lines and planes.**

**Theorem 2.1.11** *Let  $A$  be a projective plane and  $p$  a point in  $\mathbb{P}(V)$  incident to  $A$ . The set of lines incident to  $A$  and  $p$  is self-dual.*

## 2.2 The Klein Quadric

Let  $V$  be a four dimensional complex vector space. The vector space  $\bigwedge^n V$  is the  $n^{\text{th}}$  exterior product of  $V$ . In particular, if  $V = \mathbb{C}a_0 \oplus \mathbb{C}a_1 \oplus \mathbb{C}b_0 \oplus \mathbb{C}b_1$  has a basis then  $\bigwedge^2 V = \mathbb{C}a_0 \wedge a_1 \oplus \mathbb{C}a_0 \wedge b_0 \oplus \mathbb{C}a_0 \wedge b_1 \oplus \mathbb{C}a_1 \wedge b_0 \oplus \mathbb{C}a_1 \wedge b_1 \oplus \mathbb{C}b_0 \wedge b_1$  is a six dimensional complex vector space and  $\bigwedge^4 V = \mathbb{C}a_0 \wedge a_1 \wedge b_0 \wedge b_1$  is one dimensional.

Now, the alternating product defines a map  $\bigwedge^2 V \times \bigwedge^2 V \rightarrow \bigwedge^4 V$  by

$$(\alpha, \beta) \rightarrow \alpha \wedge \beta. \quad (2.1)$$

Thus, with respect to a choice of basis for  $\bigwedge^4 V$ ,  $\langle, \rangle_K$  defines a bilinear form on  $\bigwedge^2 V \cong \mathbb{C}^6$ .

Given  $V = \mathbb{C}a_0 \oplus \mathbb{C}a_1 \oplus \mathbb{C}b_0 \oplus \mathbb{C}b_1$ , I will write

$$\alpha \wedge \beta = \langle \alpha, \beta \rangle_K a_0 \wedge a_1 \wedge b_0 \wedge b_1 \quad (2.2)$$

with the understanding that a different choice of basis will scale  $\langle \alpha, \beta \rangle_K$  by the determinant of the change of basis.

**Theorem 2.2.1**  $\langle, \rangle_K$  is a nondegenerate bilinear, symmetric form on  $\bigwedge^2 V \cong \mathbb{C}^6$ .

Now, if

$$\begin{aligned}\alpha &= z_{12}a_0 \wedge a_1 + z_{13}a_0 \wedge b_0 + z_{14}a_0 \wedge b_1 + z_{23}a_1 \wedge b_0 + z_{24}a_1 \wedge b_1 + z_{34}b_0 \wedge b_1, \\ \beta &= w_{12}a_0 \wedge a_1 + w_{13}a_0 \wedge b_0 + w_{14}a_0 \wedge b_1 + w_{23}a_1 \wedge b_0 + w_{24}a_1 \wedge b_1 + w_{34}b_0 \wedge b_1,\end{aligned}$$

then

$$\langle \alpha, \beta \rangle_K = (z_{12}w_{34} + z_{34}w_{12}) - (z_{13}w_{24} + z_{24}w_{13}) + (z_{14}w_{23} + z_{23}w_{14}). \quad (2.3)$$

Given a bilinear symmetric form it is natural to define the associated quadratic form  $q : \bigwedge^2 \mathbb{C}^4 \rightarrow \mathbb{C}$  by

$$q(\alpha) = \langle \alpha, \alpha \rangle_K. \quad (2.4)$$

Thus, solutions of the homogeneous equation

$$z_{12}z_{34} - z_{13}z_{24} + z_{14}z_{23} = 0, \quad (2.5)$$

the zero set of  $q$  is a quadric surface in  $\mathbb{P}(\bigwedge^2 \mathbb{C}^4)$ . Note that a change of basis for  $V$  changes the value of  $q$  by a scalar multiple and does not alter the zero set. Hence one obtains the *Klein quadric*:

**Theorem 2.2.2** *Let  $Kl = \{[\alpha] \in \mathbb{P}(\bigwedge^2 V) : \alpha \wedge \alpha = 0\}$ . Then  $Kl$  is a four dimensional complex projective variety in  $\mathbb{P}(\bigwedge^2 V) \cong \mathbb{C}\mathbb{P}^5$ .*

**Proposition 2.2.3** *Let  $U < V$  be a subspace such that  $\langle \alpha, \beta \rangle_K$  restricted to  $U$  is zero. The maximum of  $\dim(U)$  is 3.*

**Corollary 2.2.4** *The maximum dimension of a projective linear subset of  $Kl$  is two.*

One says that an element of  $\bigwedge^2 \mathbb{C}^n$  is decomposable if it may be written as  $v \wedge w$  for some  $v, w \in \mathbb{C}^n$ .

**Lemma 2.2.5** *Let  $\dim(W) = 3$ , then every element of  $\bigwedge^2 W$  is decomposable.*

**Proof.** Let  $\beta \in \bigwedge^2 W$ . Define a map  $W \rightarrow \bigwedge^3 W \cong \mathbb{C}$  by

$$w \mapsto w \wedge \beta. \quad (2.6)$$

Then the dimension of the kernel of this map is 2. Choose a basis  $\{k_1, k_2\}$  for the kernel and extend to a basis so that  $W = \mathbb{C}k_1 \oplus \mathbb{C}k_2 \oplus \mathbb{C}u$ . Now,

$$\begin{aligned}\beta &= xk_1 \wedge k_2 + yk_1 \wedge u + zu \wedge k_1 \\ &= xk_1 \wedge k_2 + u \wedge (zk_1 - yk_2).\end{aligned}\tag{2.7}$$

Then,  $\beta \wedge k_1 = 0$  implies  $y = 0$  and  $\beta \wedge k_2 = 0$  implies  $z = 0$  so that

$$\beta = xk_1 \wedge k_2.$$

■

**Theorem 2.2.6** *Let  $\dim(V) = 4$ , then  $\alpha \in \wedge^2 V$  is decomposable if and only if  $[\alpha] \in Kl \subset \mathbb{P}(\wedge^2 V)$ .*

**Proof.** Suppose  $\alpha = v \wedge w$ , then  $\alpha \wedge \alpha = 0$ .

Now, assume  $\alpha \wedge \alpha = 0$ . Choose a basis for  $V$ , writing

$$\begin{aligned}\alpha &= z_{12}a_0 \wedge a_1 + z_{13}a_0 \wedge b_0 + z_{14}a_0 \wedge b_1 \\ &\quad + z_{23}a_1 \wedge b_0 + z_{24}a_1 \wedge b_1 + z_{34}b_0 \wedge b_1,\end{aligned}$$

Let  $W = \text{Span}\{a_0, a_1, b_0\}$  and write

$$\begin{aligned}\alpha &= z_{12}a_0 \wedge a_1 + z_{13}a_0 \wedge b_0 + z_{23}a_1 \wedge b_0 \\ &\quad + (z_{14}a_0 + z_{24}a_1 + z_{34}b_0) \wedge b_1,\end{aligned}$$

so that

$$\alpha = \beta + w \wedge b_1$$

where  $w \in W$  and  $\beta \in \wedge^2 W$ . If  $\beta = 0$  then  $\alpha$  is decomposable. So, assume  $\beta \neq 0$ . Since  $\dim(W) = 3$ ,  $\beta = v_1 \wedge v_2$  by the lemma. Then

$$0 = \alpha \wedge \alpha = 2\beta \wedge w \wedge b_1.\tag{2.8}$$

But,  $b_1 \notin W$  implies

$$\beta \wedge w = 0.$$

Thus,  $w \in \text{span}\{v_1, v_2\}$ , Write  $U = \text{Span}\{v_1, v_2, b_1\}$  then  $\alpha \in \wedge^2 U$  and  $\dim(U) = 3$  implies that  $\alpha$  is decomposable. ■

Let  $\alpha \in Kl$ ; then  $\alpha = v \wedge w$ . Write

$$v = x_1 a_0 + x_2 a_1 + x_3 b_0 + x_4 b_1 \quad (2.9)$$

$$w = y_1 a_0 + y_2 a_1 + y_3 b_0 + y_4 b_1;$$

then

$$\begin{aligned} v \wedge w = & (x_1 y_2 - x_2 y_1) a_0 \wedge a_1 + (x_1 y_3 - x_3 y_1) a_0 \wedge b_0 + (x_1 y_4 - x_4 y_1) a_0 \wedge b_1 + \\ & (x_2 y_3 - x_3 y_2) a_1 \wedge b_0 + (x_2 y_4 - x_4 y_2) a_1 \wedge b_1 + (x_3 y_4 - x_4 y_3) b_0 \wedge b_1 \end{aligned} \quad (2.10)$$

Consider a matrix  $M$  in the set of  $4 \times 2$  complex matrices. Write  $M = (v, w)$  where  $v, w \in V = \mathbb{C}a_0 \oplus \mathbb{C}a_1 \oplus \mathbb{C}b_0 \oplus \mathbb{C}b_1$ . Then there is a natural map sending  $M \mapsto v \wedge w$ . But,  $v \wedge w = 0$  if and only if  $\{v, w\}$  is linearly dependent, so one can restrict attention to matrices of rank two. Further, one can reduce a  $4 \times 2$  matrix of rank 2 to the form

$$\begin{pmatrix} z_{11} & z_{12} \\ z_{21} & z_{22} \\ 1 & 0 \\ 0 & 1 \end{pmatrix}. \quad (2.11)$$

Then,

$$M \mapsto (z_{11} z_{22} - z_{21} z_{12}) a_0 \wedge a_1 + z_{11} a_0 \wedge b_1 + z_{12} a_0 \wedge b_0 + z_{22} a_1 \wedge b_0 + z_{21} a_1 \wedge b_1 + b_0 \wedge b_1.$$

Note that this map parametrizes, by  $2 \times 2$  matrices, the intersection of an affine chart of  $\mathbb{P}(\wedge^2 V) \cong \mathbb{C}\mathbb{P}^5$  with  $Kl$ . One can also see that by permutation of rows of a given matrix  $M$  it is possible to parametrize  $Kl$  for all six affine charts of  $\mathbb{C}\mathbb{P}^5$ .

**Theorem 2.2.7** PLÜCKER EMBEDDING *The set of lines in three dimensional complex projective space is exactly parameterized by the Klein quadric.*

**Proof.** A projective line in  $\mathbb{P}(V)$  is uniquely determined by a two dimensional subspace of  $V$ . It is sufficient to consider the set of two dimensional subspaces of  $V$  to show that the set of lines in  $\mathbb{P}(V)$  is in bijective correspondence with the Klein quadric.

Let  $U$  be a two dimensional subspace of  $V$ . Choose a basis  $\{v, w\}$  for  $U$ : two dimensional subspaces are determined by a choice of basis up to linear combination. Now, define the Plücker map by

$$pl : U \rightarrow [v \wedge w] \in \mathbb{P}(\bigwedge^2 V) \quad (2.12)$$

Giving  $U$  a different choice of basis  $\{v' = av + bw, w' = cv + dw\}$ ,  $pl(U) = [\det(a, b, c, d)v \wedge w] = [v \wedge w]$ ; so  $pl$  is well-defined. Then the image of  $pl$  is contained within the Klein quadric by construction. Let  $[v \wedge w] \in Kl$  and define a map which sends  $[v \wedge w] \rightarrow \text{Span}\{v, w\} < V$ . Then  $\text{Span}\{v, w\} = \text{Span}\{v', w'\}$  implies  $\{v', w'\}$  can be written as a linear combination of  $\{v, w\}$ . Hence it is obtained that each point in the Klein quadric corresponds to exactly one line in  $\mathbb{P}(V)$  and parametrizations for the Klein quadric define complex coordinates on the set of lines in  $\mathbb{P}(V) \cong \mathbb{C}\mathbb{P}^3$ . ■

### 2.2.1 The incidence geometry of lines in the Klein quadric

Given that the set of lines can be indentified with points in the Klein quadric, I will refer to the same 'line' by the same reference regardless of whether it is considered as a subset of  $\mathbb{P}(V)$  or a point in  $\mathbb{P}(\bigwedge^2 V)$ . In addition I will, when not causing confusion, conflate the element of a projective space with it's representative vector.

Since the Klein quadric is a 4 dimensional non-degerate quadric it contains the images of linear subspaces up to dimension three: it contains as subsets projective lines and planes in  $\mathbb{P}(\bigwedge^2 V)$ . The incidence geometry of lines and planes contained in the  $Kl$  can be then translated back into statements about the geometry of lines in  $\mathbb{P}(V)$ .

**Theorem 2.2.8** *Let  $l_1$  and  $l_2$  be two lines in  $\mathbb{P}(V)$ ; then  $l_1$  and  $l_2$  are incident if and only if  $pl(l_1) \wedge pl(l_2) = 0$ .*

**Proof.** Suppose that  $l_1$  and  $l_2$  are incident and let  $p = [v]$  be the point of intersection. Then  $l_1$  corresponds to  $\text{Span}\{v, v_1\}$  and  $l_2$  corresponds to  $\text{Span}\{v, v_2\}$  for some  $\{v_1, v_2\} \in V$ . Thus,  $pl(l_1) = [v \wedge v_1]$  and  $pl(l_2) = [v \wedge v_2]$  so that  $pl(l_1) \wedge pl(l_2) = 0$ .



Now, assume  $l_1$  and  $l_2$  are disjoint. Then there exist  $\{u_1, u_2\}$  such that  $pl(l_1) = [u_1 \wedge v_1]$ ,  $pl(l_2) = [u_2 \wedge v_2]$ , and  $V = \text{Span}\{u_1, v_1, u_2, v_2\}$ . But then,  $pl(l_1) \wedge pl(l_2) = u_1 \wedge v_1 \wedge u_2 \wedge v_2 \neq 0$ . ■

**Corollary 2.2.9** *Two projective lines  $l_1$  and  $l_2$  are incident in three dimensional space if and only if the projective line spanned by  $l_1$  and  $l_2$  considered as points in  $\mathbb{P}(\wedge^2 \mathbb{C}^4)$  is contained in the Klein quadric.*

**Proof.** Suppose  $l_1$  and  $l_2$  are incident; then  $l_1 = [v \wedge v_1]$  and  $l_2 = [v \wedge v_2]$  where  $[v]$  is the point of incidence. Let  $[\alpha]$  be a point on the line in  $\mathbb{P}(\wedge^2 V)$  spanned by  $l_1$  and  $l_2$ , then  $\alpha = xl_1 + yl_2 \in \text{Span}\{v \wedge v_1, v \wedge v_2\} \subset \wedge^2 V$ . Then,

$$\alpha \wedge \alpha = (2xy)l_1 \wedge l_2 = (2xy)v \wedge v_1 \wedge v \wedge v_2 = 0.$$

Now, assume the projective line spanned by  $l_1$  and  $l_2$  is contained in the Klein quadric. Let  $[\alpha]$  be a point on that line, then  $\alpha \wedge \alpha = 0$ . But this implies  $l_1 \wedge l_2 = 0$ . Hence  $l_1$  and  $l_2$  are incident ■

**Proposition 2.2.10** *Let  $[\alpha]$  be a point on a line contained in the Klein quadric, then there exist lines  $l_1, l_2 \subset \mathbb{P}(V)$ , incident at a point, such that the line represented by  $\alpha$  is contained in the projective plane spanned by  $l_1$  and  $l_2$ .*

**Proof.** Since the line is contained in  $Kl$ , choose two points  $l_1$  and  $l_2$  which will then span the line;  $l_1$  and  $l_2 \subset \mathbb{P}(V)$  are incident at a point  $u$  by the previous corollary. Now, write

$$\alpha = xu \wedge v_1 + yu \wedge v_2 = u \wedge (xv_1 + yv_2). \tag{2.13}$$

From this equation one observes that  $\alpha$  is contained in the projective plane spanned by  $[u]$ ,  $[v_1]$ , and  $[v_2]$  in  $\mathbb{P}(V)$  and is incident to  $[u]$ . ■

Thus, one obtains: a projective plane and a point contained in that plane in  $\mathbb{P}(V)$  define a line contained within the Klein quadric.

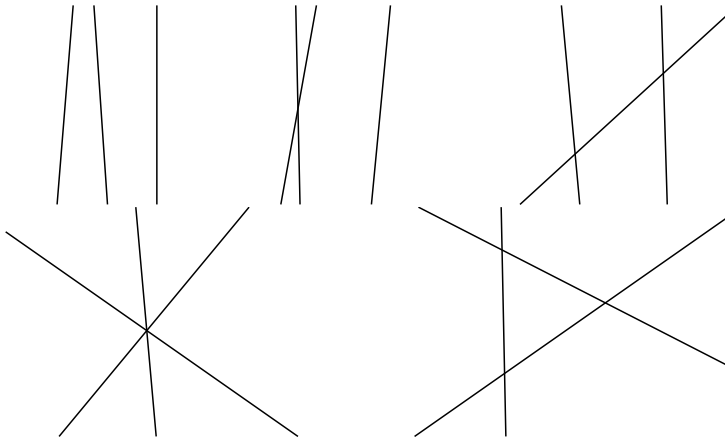

**Figure 5.** Correspondence between planar pencil in  $\mathbb{C}\mathbb{P}^3$  and line in  $Kl$ .

**Theorem 2.2.11** *A line contained within the Klein quadric in  $\mathbb{P}(\wedge^2 V)$  corresponds to the set of lines in  $\mathbb{P}(V)$  contained within a fixed projective plane all passing through exactly one point.*

Since  $Kl$  is a non-degenerate quadric in  $\mathbb{C}\mathbb{P}^5$  it must contain projective planes as subsets. Three points in  $Kl$  not all incident to a line span a projective plane in  $\mathbb{P}(\wedge^2 V)$ . The intersection of that plane with  $Kl$  is determined by the rank of the bilinear form  $\langle, \rangle_K$  restricted to the three dimensional subspace generated by these three points. Now, consider the possible configurations of lines in  $\mathbb{P}(V)$  corresponding to these three points.

**Lemma 2.2.12** *There are 5 incidence configurations of lines in space corresponding to three non-collinear points in  $Kl$ .*



**Figure 6.** Five configurations and four induced ranks.

From these incidence relations it is possible to compute the induced bilinear form and

observe the rank since given two lines  $e_1, e_2$ , in  $\mathbb{P}(V)$   $e_1$  is incident to  $e_2$  if and only if  $\langle e_1, e_2 \rangle_K = 0$ .

**Theorem 2.2.13** *Let  $e_1, e_2$ , and  $e_3$  be three distinct lines in  $\mathbb{P}(V)$ . Consider the plane spanned by the corresponding three points in  $\mathbb{P}(\wedge^2 V)$  and the rank of the induced bilinear form:*

1. *if  $\{e_1, e_2, e_3\}$  are disjoint then the rank is 3,*
2. *if  $\{e_1, e_2\}$  are incident and  $e_3$  is totally disjoint then the rank is 2,*
3. *if  $\{e_1, e_2\}$  are disjoint and  $e_3$  is incident to each then the rank is 2,*
4. *if  $\{e_1, e_2, e_3\}$  are each mutually incident then the rank is 0.*

If the rank of the induced bilinear form on the subspace generated by the three points is non-zero, then the intersection of the associated projective plane with  $Kl$  is a, possibly degenerate, one dimensional quadric surface, i.e. a 'conic.'

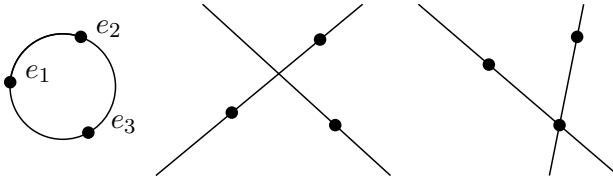

**Figure 7. Three configurations and two induced ranks.**

If the rank of the induced form is 0, the projective plane spanned by the three points is contained entirely within  $Kl$ . Thus each pair of points spans a line contained within  $Kl$  implies each pair of lines is incident. There are two possibilities: either all three lines intersect in one common point or each pair of lines intersect in a unique point and all three lie in a common plane. Thus every plane contained within the Klein quadric is generated by a triple of points corresponding to lines with the preceding incidence pattern. However a stronger statement is possible.

**Theorem 2.2.14 ( $\alpha$ -plane)** *Suppose  $\{e_1, e_2, e_3\}$  are three lines in  $\mathbb{P}(V)$  all incident to a common point  $[u]$ . Let  $\Pi$  be the projective plane contained within  $Kl$  generated by*

$\{e_1, e_2, e_3\}$ . If  $l$  is a line in  $\mathbb{P}(V)$ , then  $l \in \Pi$  if and only if it is incident to  $[u]$ .  $\Pi$  is called an  $\alpha$ -plane.

**Proof.** Since  $\{e_1, e_2, e_3\}$  are disjoint and incident to  $[u]$ , they may be written  $\{v_1 \wedge u, v_2 \wedge u, v_3 \wedge u\}$  for linearly independent vectors  $\{v_1, v_2, v_3\}$ . Then  $\{v_1, v_2, v_3, u\}$  form a basis for  $V$ . Let  $x$  be a line in  $\mathbb{P}(V)$  incident to  $[u]$ , then  $x = v \wedge u$  where  $v$  may be considered to be in the span of  $\{v_1, v_2, v_3\}$ . This implies that  $v \wedge u$  is in the span of  $\{v_1 \wedge u, v_2 \wedge u, v_3 \wedge u\}$  hence  $x \in \Pi$ . Now, assume that  $x \in \Pi$ , then  $x = av_1 \wedge u + bv_2 \wedge u + cv_3 \wedge u = (av_1 + bv_2 + cv_3) \wedge u$  is incident to  $[u]$ . ■

**Theorem 2.2.15 ( $\beta$ -plane)** Suppose  $\{e_1, e_2, e_3\}$  are three lines in  $\mathbb{P}(V)$  all contained within a projective plane  $X$  and thus mutually intersecting. Let  $\Xi$  be the projective plane contained within  $Kl$  generated by  $\{e_1, e_2, e_3\}$ . If  $l$  is a line in  $\mathbb{P}(V)$ , then  $l \in \Xi$  if and only if  $l$  is contained in  $X$

**Proof.**

Write the three points of intersection of  $e_1, e_2,$  and  $e_3$  as  $\{u_1, u_2, u_3\}$ , then  $e_1 = u_1 \wedge u_2$ ,  $e_2 = u_2 \wedge u_3$ , and  $e_3 = u_3 \wedge u_1$ . Let  $l$  be a line contained in  $X$ . Then  $l$  is incident to  $e_1, e_2,$  and  $e_3$  since they are also contained in  $X$ . Thus one may write

$$\begin{aligned} l &= (xu_1 + u_2) \wedge (yu_2 + u_3) \\ &= xyu_2 \wedge u_1 + xu_3 \wedge u_1 + u_3 \wedge u_2 \end{aligned}$$

given it intersects  $e_1$  and  $e_2$ . Hence  $l \in P(\text{Span}\{u_1 \wedge u_2, u_2 \wedge u_3, u_3 \wedge u_1\}) = \Xi$ . Now, suppose  $l$  is in  $\Xi$ . Then the lines spanned by  $\{l, e_1\}$  and  $\{l, e_2\}$  are contained in  $\Xi$ . Hence  $l$  intersects  $e_1$  and  $e_2$  and is contained in the plane spanned by these two lines which is  $X$ . ■

The  $\alpha$ -plane and  $\beta$ -plane terminology originates with Felix Klein in his dissertation: “Über die Transformation der allgemeinen Gleichung des zweiten Grades zwischen Linien-Koordinaten auf eine kanonische Form.”

**Corollary 2.2.16** *Every projective line contained in the Klein quadric is given as the intersection of an  $\alpha$  and  $\beta$  plane.*

**Proof.** By the previous lemma, a line in  $Kl$  is given by all the lines in  $\mathbb{P}(V)$  incident to a fixed point  $x$  and contained in a fixed plane  $\Pi$ . Now, consider the  $\beta$  plane defined by all the lines contained in  $\Pi$  and the  $\alpha$  plane defined by all the lines in  $\mathbb{P}(V)$  incident to  $x$ . The intersection of these two sets is exactly  $l$ . ■

**Corollary 2.2.17** *A line in the Klein quadric is characterized by a pair  $\{q, \Pi\}$  of a point and plane in  $\mathbb{C}\mathbb{P}^3$  with the property that  $q$  is incident to  $\Pi$ .*

**Proof.** The intersection of an  $\alpha$ -plane and  $\beta$ -plane in  $Kl$  is seen in  $\mathbb{C}\mathbb{P}^3$  as the set of lines incident to a single point all contained in a single plane. ■

### 2.2.2 $S^4$ defined by a real structure on the Klein Quadric

Consider the quaternions:  $\mathbb{H} = \mathbb{R} \oplus i\mathbb{R} \oplus j\mathbb{R} \oplus k\mathbb{R}$ , as a four dimensional real vector space. Then identify the complex numbers  $\mathbb{C}$  with quaternions of the form  $\mathbb{R} \oplus i\mathbb{R}$  so that  $\mathbb{H} = \mathbb{C} \oplus j\mathbb{C}$  is also a two dimensional complex vector space.

One may define quaternionic vector spaces in analogy to vector spaces with the same concepts of linear independence and dimension; however, right and left quaternionic vector spaces are no longer equivalent since  $\mathbb{H}$  is not commutative. Hence, consider a two dimensional right quaternionic vector space  $V$ . Since  $\mathbb{H}$  acts on  $V$  from the right, the action of  $\mathbb{C} \subset \mathbb{H}$  gives  $V$  the structure of a complex right vector space. By construction  $x$  and  $xj$  are then complex linearly independent.

**Proposition 2.2.18** *Let  $V$  be a two dimensional quaternionic vector space with a basis  $\{e_1, e_2\}$  then  $\{e_1, e_1j, e_2, e_2j\}$  is a basis for  $V$  as a complex vector space so that  $V \cong \mathbb{C}^4$ .*

**Proof.** Let  $x = e_1a + e_2b$ , then  $a = a_1 + ja_2$  and  $b = b_1 + jb_2$ , since  $\mathbb{H} = \mathbb{C} \oplus j\mathbb{C}$ , so that  $x = e_1a_1 + e_1ja_2 + e_2b_1 + e_2jb_2$ . If you made the choice  $\mathbb{H} = \mathbb{C} \oplus \mathbb{C}j$ , then the resulting coordinates on  $\mathbb{C}^4$  would be given by  $x = e_1a_1 + e_1j\bar{a}_2 + e_2b_1 + e_2j\bar{b}_2$ . ■

**Corollary 2.2.19** *Suppose  $v, w \in V$  are quaternionic linearly independent vectors, then  $(v\mathbb{C} \oplus vj\mathbb{C}) \cap (w\mathbb{C} \oplus wj\mathbb{C}) = \{0\}$ .*

Now,  $\mathbb{H}$  operates (from the right) on  $\mathbb{C}^4 \cong \mathbb{H}^2$  as a complex vector space. Since  $k = ij$ , it suffices to consider the action of  $j$ . Let  $x \in V$ , then

$$(xi)j = xj(-i)$$

is a complex anti-linear map on  $\mathbb{C}^4$ .

**Definition:** Let  $M$  be a complex manifold.  $\rho : M \rightarrow M$  is a real structure on  $M$  if it is anti-holomorphic with the property  $\rho^2 = Id$ . The fixed set or set of “real points” of a real structure  $\rho$  is given by  $\{x \in M : \rho(x) = x\}$ .

The real points of a real structure are sometimes referred to as a “real manifold” or “totally real manifold.” The first example of a real structure is given by complex conjugation on a complex  $n$ -dimensional vector space. The set of real points forms a  $n$ -dimensional real vector space.

**Proposition 2.2.20** *Let  $W \cong \mathbb{C}^n$  be a complex vector space with real structure  $\tilde{\rho}$ , given by an anti-linear map, then there exists a real structure on  $\mathbb{P}(W)$  defined by  $\rho([x]) = [\tilde{\rho}(x)]$ . The real points of  $\tilde{\rho}$  form a  $n$ -dimensional real vector space.*

**Proof.** Observe that  $W \cong \mathbb{R}^{2n}$ . Then,  $\rho$  is real linear on  $W$  with eigenvalues  $\{+1, -1\}$ . Finally, if  $\rho(x) = x$ , then  $\rho(xi) = -xi$ , so that the dimensions of both eigenspaces are equal. ■

However, the set of real points of a real structure may be empty.

**Proposition 2.2.21** *Let  $V = \mathbb{H}^2$ , then right multiplication by  $j$  on  $V \cong \mathbb{C}^4$  defines a real structure on  $\mathbb{P}(V)$ . The set of real points is empty.*

**Proof.** Define  $\rho : \mathbb{P}(V) \rightarrow \mathbb{P}(V)$  by  $\rho([x]) = [xj]$ ; right multiplication is complex anti-linear on  $V$  and  $\rho^2([x]) = [-x] = [x]$ .  $x$  and  $xj$  are complex linearly independent so  $[x] \neq [xj]$ . ■

Observe that there are invariant two dimensional subspaces of  $V$  under  $\rho$ ; consider  $\text{Span}_{\mathbb{C}}\{v, vj\}$ . Hence there are projective lines in  $\mathbb{P}(V)$  that are fixed by the real structure on  $\mathbb{P}(V)$ .

**Proposition 2.2.22** *Let  $\rho$  be the real structure defined by right multiplication by  $j$  on  $V \cong \mathbb{C}^4$ . The maximum  $\rho$ -invariant proper linear subspace in  $V$  is two-dimensional.*

**Proof.** Let  $W < V$  be a three dimensional subspace. Suppose  $\rho(W) = W$ . Given a basis  $W = \{u, v, w\}$  this implies  $W_1 = \text{Span}_{\mathbb{C}}\{u, uj\}$  and  $W_2 = \text{Span}_{\mathbb{C}}\{v, vj\} < W$ . But then  $\dim(W) = 3$  implying  $W_1 \cap W_2 \neq \{0\}$  is a contradiction as twistor fibers are disjoint. ■

**Proposition 2.2.23** *Let  $\Pi$  be a projective plane in  $\mathbb{P}(V)$ , then  $\Pi$  contains exactly one  $j$ -invariant line.*

**Proof.**  $\Pi j$  is a projective plane since right multiplication by  $j$  is anti-linear. But then  $\Pi j \neq \Pi$  implies  $\Pi j \cap \Pi = \alpha = u \wedge v$  is a projective line. Now, extend  $l$  to a basis for  $\Pi$  by choosing a point  $[w]$  in  $\Pi$  within the complement of  $l$ . Thus  $\Pi = \text{Span}\{u, v, w\}$  and  $\Pi j = \text{Span}\{u, v, wj\}$  since  $w \notin l$ . Now, consider  $h \in l$ ;  $h = ua + vb$ . Suppose  $hj \notin l$ , then  $hj = ux + vy + wjz$ . But this implies  $wj \in l$  which is a contradiction. Hence  $hj \in l$  and  $l = \text{Span}\{h, hj\}$  is invariant. ■

This may be viewed inside the Klein quadric. Let  $x = va + wb \in \text{Span}\{v, w\}$  be a point on a line in  $\mathbb{P}(V)$  then right action by  $j$  sends this point to  $xj = v\bar{a} + w\bar{b} \in \text{Span}\{vj, wj\}$ . Thus right action of  $j$  sends the line  $v \wedge w$  to  $vj \wedge wj$ . Note that  $j^2 = -1$  leaves the line invariant or  $(-v) \wedge (-w) = v \wedge w$ .

**Lemma 2.2.24** *Right multiplication by  $j$  on  $V$  induces a real structure on the complex vector space  $\bigwedge^2 V$  given by  $\tilde{\rho}(v \wedge w) = (vj) \wedge (wj)$ .*

Starting with the quaternionic basis  $\{v, w\}$  of  $V$ , the basis  $\{v, vj, w, wj\}$  spans  $V \cong \mathbb{C}^4$ , and then  $\bigwedge^2 V$  is spanned by

$$\{v \wedge vj, v \wedge w, v \wedge wj, vj \wedge w, vj \wedge wj, w \wedge wj\}. \quad (2.14)$$

One then computes the matrix of  $\langle, \rangle_K$  with respect to this basis as

$$\begin{bmatrix} 0 & 0 & 0 & 0 & 0 & 1 \\ 0 & 0 & 0 & 0 & 1 & 0 \\ 0 & 0 & 0 & 1 & 0 & 0 \\ 0 & 0 & 1 & 0 & 0 & 0 \\ 0 & 1 & 0 & 0 & 0 & 0 \\ 1 & 0 & 0 & 0 & 0 & 0 \end{bmatrix} \quad (2.15)$$

**Lemma 2.2.25** *Right multiplication by  $j$  on  $\bigwedge^2 V$  induces a real structure on the Klein quadric as a projective variety in  $\mathbb{P}(\bigwedge^2 V)$ . The set of real points in  $Kl$  is the projective image of the intersection of a six dimensional real vector space with the zero set of  $\langle, \rangle_K$ .*

**Proof.** By observation  $\rho$ , the induced real structure on  $\mathbb{P}(\bigwedge^2 V)$ , restricts to a real structure on  $Kl$ . Now, it remains to determine the real set of  $\rho$ . Following the previous lemma, the real set on  $\bigwedge^2 V$  is a six dimensional real vector space. Hence the points in  $Kl$  fixed by  $\rho$  are determined by computing the zero set of the restriction of  $\langle, \rangle_K$  to the real set of  $\bigwedge^2 V$ . ■

Now, given the basis for  $\bigwedge^2 V$  one may determine a new basis of  $\tilde{\rho}$ -invariant vectors as follows:

$$\begin{aligned} & \{v \wedge vj + w \wedge wj, v \wedge vj - w \wedge wj, vj \wedge w - v \wedge wj, \\ & (vj \wedge w + v \wedge wj)i, v \wedge w + vj \wedge wj, (v \wedge w - vj \wedge wj)i\} = \{\omega_1, \omega_2, \omega_3, \omega_4, \omega_5, \omega_6\}. \end{aligned} \quad (2.16)$$

The real vector space generated by this basis is then the real set of  $\bigwedge^2 V$  Then, normal-



izing, one may compute the matrix of  $\langle, \rangle_K$  with respect to this new basis obtaining:

$$\begin{bmatrix} 1 & 0 & 0 & 0 & 0 & 0 \\ 0 & -1 & 0 & 0 & 0 & 0 \\ 0 & 0 & -1 & 0 & 0 & 0 \\ 0 & 0 & 0 & -1 & 0 & 0 \\ 0 & 0 & 0 & 0 & -1 & 0 \\ 0 & 0 & 0 & 0 & 0 & -1 \end{bmatrix} \quad (2.17)$$

Thus the restriction to the real set of  $\bigwedge^2 V$  is a  $(1, 5)$  real bilinear form. The zero set of this form is the light-cone in  $\mathbb{R}^6$ . Hence, under projection, one obtains the model of  $S^4$  contained in  $\mathbb{RP}^5 \subset \mathbb{P}(\bigwedge^2 V) \cong \mathbb{CP}^5$  as the intersection of an  $\mathbb{RP}^5$  with the Klein quadric. An element of this real set in  $Kl$  is a line invariant under the action of  $j$  on  $\mathbb{P}(V) \cong \mathbb{CP}^3$ . Hence, the following is obtained:

**Theorem 2.2.26** *The set of  $j$ -invariant lines is parametrized by the real four dimensional sphere.*

**Corollary 2.2.27** *Each  $\alpha$  and  $\beta$  plane intersect  $S^4 \subset Kl$  in exactly one point.*

### 2.3 Spheres and $\mathbb{HP}^1$

Given a four dimensional complex vector space  $V \cong \mathbb{C}^4 \cong \mathbb{H}^2$ . It has been shown that the  $j$ -invariant lines in  $\mathbb{P}(V)$  are parameterized by  $S^4$ . Remember that a  $j$ -invariant line is determined by a two dimensional subspace of  $V$  of the form  $\text{Span}\{v, vj\}$ . Consider  $V$  to be a two dimensional quaternionic vector space, then  $\{v, vj\} \subset v\mathbb{H}$ . Let  $\alpha = a_0 + ja_1 \in \mathbb{H}$ , then  $v\alpha = va_0 + vja_1 \in \text{Span}\{v, vj\}$ . Since  $\text{Span}\{v, vj\}$  is  $j$ -invariant,  $\text{Span}\{v, vj\} = \text{Span}\{v\alpha, v\alpha j\}$ . Note that  $v\alpha \wedge vj\bar{\alpha} = v \wedge vj(|a_0|^2 + |a_1|^2)$ .

Each  $j$ -invariant line  $v \wedge vj$  corresponds to a 'quaternionic' one dimensional subspace  $v\mathbb{H} < V$ . The set of one dimensional quaternionic subspaces of  $\mathbb{H}^2$  will be considered in analogy to the set of one dimensional complex subspaces of  $\mathbb{C}^2$  :

**Definition:**  $\mathbb{H}\mathbb{P}^1 = \{[v] : v \in \mathbb{H}^2 \setminus \{0\} \text{ and } [v] = [w] \text{ iff } v = w\alpha, \alpha \in \mathbb{H} \setminus \{0\}\}$ .

So, the set of  $j$ -invariant lines in  $\mathbb{C}\mathbb{P}^3$  corresponds to the set of points in a one dimensional quaternionic projective space and as a consequence of Theorem 2.2.26 one obtains:

**Corollary 2.3.1**  $\mathbb{H}\mathbb{P}^1 \cong S^4$ .

Let  $x \in \mathbb{C}\mathbb{P}^3$ , then one may define a map  $\tau : \mathbb{C}\mathbb{P}^3 \rightarrow \mathbb{H}\mathbb{P}^1$  by projecting  $[v] \in \mathbb{C}\mathbb{P}^3$  along the line  $v \wedge vj$ . This is well defined since  $\mathbb{C} \subset \mathbb{H} = \mathbb{C} \oplus j\mathbb{C}$ .

**Definition:** Let  $\tau : \mathbb{C}\mathbb{P}^3 \rightarrow \mathbb{H}\mathbb{P}^1$  be the “twistor projection” defined by  $v\mathbb{C} \mapsto v\mathbb{H}$ . The fiber of the twistor projection  $\tau^{-1}(v\mathbb{H}) = \mathbb{P}(v\mathbb{C} \oplus vj\mathbb{C})$  is the line  $v \wedge vj$ .

Now, consider a line  $\sigma \subset \mathbb{P}(V)$  which is not  $j$ -invariant. Choose two points  $\{v, w\}$  so that  $\sigma = v \wedge w$ .  $\sigma j$  is disjoint from  $\sigma$  and spanned by  $\{vj, wj\}$ . Let  $[u] \in \mathbb{C}\mathbb{P}^3$ , then  $u \wedge uj$  is a point in  $S^4 \subset Kl$ . Thus, one may identify  $\tau(\sigma)$  with the set of points  $\{u \wedge uj : u \in \sigma\} \subset S^4$ .

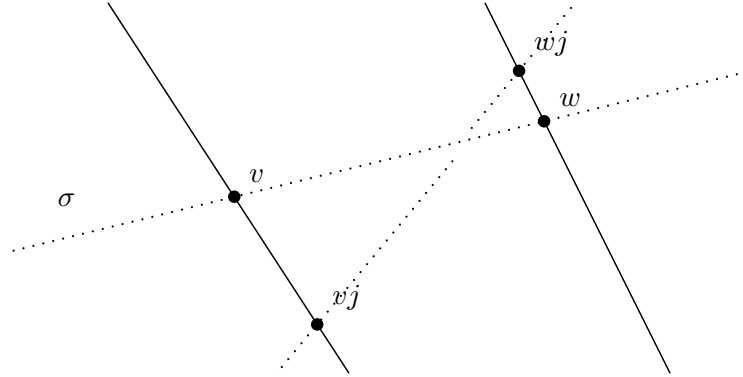

**Figure 8.** A line  $\sigma$  and the image of that line  $\sigma j$ .

**Theorem 2.3.2** Let  $\sigma$  be a line in  $\mathbb{C}\mathbb{P}^3$  such that  $\sigma \cap \sigma j = \emptyset$ , then  $\{u \wedge uj : u \in \sigma\} \cong S^2 \subset S^4$ .

**Proof.** Choose  $v, w \in \sigma$  such that  $\sigma = v \wedge w$ . Then,  $V = v\mathbb{H} \oplus w\mathbb{H} \cong \mathbb{H}^2$  since  $\sigma \cap \sigma j = \emptyset$ . This induces a basis for  $\wedge^2 V$ . Let  $l$  be a line in  $\mathbb{P}(V)$ .  $l$  is incident to  $\sigma$  iff  $\langle l, \sigma \rangle_K = 0$ .

Hence, the set of lines incident to  $\sigma$  is contained within  $\sigma^\perp = \mathbb{P}(v \wedge w^\perp) \cong \mathbb{C}\mathbb{P}^4 < \mathbb{P}(\wedge^2 V)$  where, in the basis induced by  $\{v, w\}$ ,

$$\sigma^\perp = \text{Span}\{v \wedge vj, v \wedge w, v \wedge wj, vj \wedge w, w \wedge wj\}. \quad (2.18)$$

Let  $u \in \sigma$  then  $uj \in \sigma j$  so that the line  $u \wedge uj$  is incident to  $\sigma$  and  $\sigma j$ . Hence the image of  $\sigma$  under the twistor projection is given by all the  $j$ -invariant lines incident to  $\sigma$  and  $\sigma j$ . This set is contained with the set of all lines incident to  $\sigma$  and  $\sigma j$ :

$$\sigma^\perp \cap \sigma j^\perp \cap Kl.$$

Then,

$$\sigma j^\perp = \text{Span}\{v \wedge vj, v \wedge wj, vj \wedge w, vj \wedge wj, w \wedge wj\} \quad (2.19)$$

so that

$$\begin{aligned} \sigma^\perp \cap \sigma j^\perp &= \text{Span}\{v \wedge vj, v \wedge wj, vj \wedge w, w \wedge wj\} \\ &= \text{Span}\{v \wedge vj + w \wedge wj, v \wedge vj - w \wedge wj, \\ &\quad v \wedge wj - vj \wedge w, (v \wedge wj + vj \wedge w)i\}. \end{aligned}$$

This last set of basis elements spans, as a real four dimensional vector space, the set of  $j$ -invariant forms. Then, one computes that the signature of  $\langle, \rangle_K$  restricted to this real vector space is  $(1, 3)$ . Thus the projective image of the null set of  $\langle, \rangle_K$  in  $\sigma^\perp \cap \sigma j^\perp$  is a round two dimensional sphere inside  $S^4$ . ■

Thus a line in  $\mathbb{C}\mathbb{P}^3$  is either a ‘twistor fiber’ and corresponds to a point in  $S^4$  or it represents a round two dimensional sphere contained in  $S^4$  given by every twistor fiber incident to the line.

**Theorem 2.3.3** *The Klein quadric parametrizes the set of oriented two dimensional round spheres contained within  $S^4$  including the points of  $S^4$ , considered as spheres of zero radius.*

What remains to be proven is that every oriented  $S^2 \subset S^4$  is represented by a unique line in  $\mathbb{C}\mathbb{P}^3$ .

**Lemma 2.3.4** *Let four points in  $S^4 \subset Kl \subset \mathbb{C}\mathbb{P}^5$  be given in general position. Then, these points are incident to a unique unoriented two-sphere contained in  $S^4$ .*

**Proof.** Four points in general position in  $\mathbb{C}\mathbb{P}^5$  span an affine linear 3-space  $\Sigma \cong \mathbb{C}\mathbb{P}^3$ . Then,  $\Sigma \cap Kl$  is a two dimensional complex quadric surface contained in  $\Sigma$ . However,  $\Sigma$  contains four real points by assumption so that the real part of  $\Sigma$  is non empty and since the real structure on  $Kl$  is induced by a real structure on  $\mathbb{C}^6$  the real part of  $\Sigma$  is thus a three dimensional real affine space. The interesection of this real space with  $S^4$  contains more than one point is therefore given by a two sphere. ■

**Remark.** Any three points lie on an affine plane whereby the fourth point defines an affine three-space if they are all in general position. Thus, any four points in  $S^4$  can be considered to lie in some  $S^3 \subset S^4$  and this result follows from classical geometrical arguments. ■

Consider the association  $S^4 \cong \mathbb{H}\mathbb{P}^1$  as given previously. Writing  $V \cong \mathbb{H}^2$  one identifies lines in  $\mathbb{C}\mathbb{P}^3$  with two dimensional complex vector spaces contained in  $\mathbb{H}^2$ . Now, quaterionic (proper) subspaces of  $\mathbb{H}^2$  are two dimensional complex vector spaces. So, one distinguishes a complex two dimensional subspace  $\sigma < \mathbb{C}^4$  by whether it is a quaterionic subspace of  $\mathbb{H}^2$  or not i.e.  $\sigma = \sigma j$  or  $\sigma \cap \sigma j = \emptyset$ .

**Proof of Theorem 2.3.3.** Let  $\sigma$  be a two sphere contained in  $S^4$ . Now, choose four points in general position on  $\sigma$  (not all lying on a circle)  $[\hat{a}], [\hat{b}], [\hat{c}],$  and  $[\hat{d}] \in \mathbb{H}\mathbb{P}^1$  so that  $\hat{c} = \hat{a} + \hat{b}$  and without loss of generality  $\hat{d} = \hat{a}u + \hat{b}$ , where  $u \in \mathbb{H}$  and  $|u| = 1$ . Since all are in general position,  $u$  is not real. Thus,  $u \in S^2 \subset Im\mathbb{H}$ . Now choose  $x \in \mathbb{H}$  so that  $x^{-1}ux = i$ . Writing  $a = \hat{a}x$  and  $b = \hat{b}x$ , one obtains  $[c] = [a + b]$  and  $[\hat{d}] = [d]$  where  $d = ai + b$ . Then  $\{a, b\}$  span a complex two dimensional vector space  $W \subset \mathbb{H}^2 \cong \mathbb{C}^4$  where  $c, d \in W$ . Let  $l_\sigma$  be the line in  $\mathbb{C}\mathbb{P}^3$  defined by  $a\mathbb{C} \oplus b\mathbb{C}$ , then the two-sphere corresponding to  $l_\sigma$  given by Lemma 2.3.2 must be  $\sigma$  by the previous lemma since it contains all four chosen points. Similarly, for the unit quaternion  $j$  one obtains  $[\hat{c}] = [c] = [aj + bj]$  and  $[\hat{d}] = [d]$  where  $d = aj(-i) + bj$ .

In the affine chart  $[a\mathbb{H} + b]$  on  $\mathbb{H}\mathbb{P}^1$  defined by  $a$  and  $b$ ,  $\sigma$  appears as the the 'complex plane,'  $[a\mathbb{C} + b] \subset [a\mathbb{H} + b]$ . Now, let  $\lambda \subset \mathbb{C}\mathbb{P}^3$  be a line corresponding to  $\sigma$  and hence containing  $[a], [b], [c]$ , and  $[d]$ . Then, since it contains  $[a]$  and  $[b]$ ,  $\lambda$  must be given by  $ax\mathbb{C} \oplus by\mathbb{C}$  for some  $x, y \in \mathbb{H}$ . But, if  $\lambda$  also corresponds to  $\sigma$  then  $x\mathbb{C}y^{-1} = \mathbb{C}$ . This implies that  $xy^{-1} \in \mathbb{C}$  and thus  $x\mathbb{C}x^{-1} = \mathbb{C}$  and  $y\mathbb{C}y^{-1} = \mathbb{C}$ . Hence  $x, y \in \mathbb{C}$  or  $\mathbb{C}j$  and  $\lambda = l_\sigma$  or  $\lambda = l_\sigma j$ .

Thus, the two-sphere  $\sigma$  corresponds to two lines in  $\mathbb{C}\mathbb{P}^3$  :  $l_\sigma$  and  $l_\sigma j$ . ■

**Remark.** This proof is related to the result that, contrary to what one would expect from  $\mathbb{C}\mathbb{P}^1$ , three points do not determine affine coordinates for  $\mathbb{H}\mathbb{P}^1$ . ■

### 2.3.1 Tangency of oriented 2-spheres in $\mathbb{H}\mathbb{P}^1$

It remains to interpret the incidence properties of lines in  $\mathbb{C}\mathbb{P}^3$  in terms of 2-spheres in  $S^4$ . It is clear that if two lines are incident in  $\mathbb{C}\mathbb{P}^3$  then the corresponding spheres intersect in a point defined by the inverse twistor image of the point of incidence. It is clear that spheres in  $\mathbb{R}^3$  touching at exactly one point are tangent at that point. In general, spheres in  $S^3$  are tangent at point or intersect in a circle. The corresponding result for spheres in  $S^4$  will be that two spheres whose representatives in  $\mathbb{C}\mathbb{P}^3$  are incident at exactly one twistor fiber are tangent. However, a sphere given in  $S^4$  has two twistor-lifts corresponding to the two possible orientations of that sphere. So, one must distinguish between tangency and oriented tangency.

**Definition:** Two-spheres in  $S^4$  which are tangent at a point and have the same orientation will be said to “touch” at that point

It will be shown that if two lines in  $\mathbb{C}\mathbb{P}^3$  are incident to exactly one twistor-fiber then the corresponding two-spheres will touch at the image point of the twistor-fiber. In general, two-spheres may be tangent at one point, intersect in two points, or intersect in a circle.

As a preliminary result: a given 2-sphere  $S$  in  $\mathbb{H}\mathbb{P}^1$  may be characterized by an endomorphism  $J : \mathbb{H}^2 \rightarrow \mathbb{H}^2$  such that

$$J^2 = -I. \quad (2.20)$$

Given  $J$ , the line in  $\mathbb{C}\mathbb{P}^3$  defining the sphere  $S$  is given by the  $i$ -eigenspace of  $J$ , where  $i \in \mathbb{C} \subset \mathbb{H}$ . This may be seen in an elementary fashion by considering the 4-point characterization of a sphere: the complex vector space  $a\mathbb{C} \oplus b\mathbb{C}$  can be seen as the set  $\{v \in \mathbb{H}^2 : Jv = vi\}$  where with respect to  $\mathbb{H}^2 = a\mathbb{H} \oplus b\mathbb{H}$ ,

$$J = \begin{pmatrix} i & 0 \\ 0 & i \end{pmatrix}. \quad (2.21)$$

Then, choosing any other point  $[ay + bz] \in \mathbb{H}\mathbb{P}^1$ , under the change of basis  $\{a, b\} \rightarrow \{ax, ay + bz\}$

$$J = \begin{pmatrix} N & H \\ 0 & R \end{pmatrix} \quad (2.22)$$

with  $N, R, H \in \mathbb{H}$  where  $N^2 = R^2 = -1$ .

**Theorem 2.3.5** *The set of 2-spheres in  $\mathbb{H}\mathbb{P}^1$  of radius greater than zero is characterized by the set  $\{J \in \text{End}(\mathbb{H}^2) \text{ such that } J^2 = -I\}$ .*

**Lemma 2.3.6** *Let a sphere be given by  $J$  such that  $J^2 = -I$ , then it is possible to choose a basis for  $\mathbb{H}^2$  so that  $J = \begin{pmatrix} N & H \\ 0 & R \end{pmatrix}$ ,  $N, R, H \in \mathbb{H}$  where  $N^2 = R^2 = -1$  and  $NH = HR$ .*

As a consequence, it is possible to talk of the “twistor lift” of a two-sphere in  $S^4$ . Let  $\sigma$  be a two-sphere and  $J$  the associated complex structure. Then, for each  $L \in \sigma$ ,  $JL = L$ .

**Twistor Lift** The twistor lift of  $L$  to  $\mathbb{C}\mathbb{P}^3$  is  $v\mathbb{C} < \mathbb{C}^4 \cong \mathbb{H}^2$  for  $v \in L$  such that  $Jv = vi$ .

This is completely equivalent to the previous discussion i.e. the twistor lift of a two-sphere in  $S^4$  is a projective line in  $\mathbb{C}\mathbb{P}^3$ . However, one can extend that discussion by

considering projective duality in  $\mathbb{C}\mathbb{P}^3$ . Let  $a \in \mathbb{C}\mathbb{P}^3$ , then  $a^*$  is a projective plane in  $\mathbb{C}\mathbb{P}^{3*}$ . By extension the dual of a projective plane is a point. However, the dual of projective line is a projective line. In particular, consider  $a \in \mathbb{H}\mathbb{P}^1$ . Then define  $a^o \in \mathbb{H}\mathbb{P}^{1*}$  by  $a^o = \{x \in \mathbb{H}^{2*} \text{ such that } x(a) = 0\}$  is a point in  $\mathbb{H}\mathbb{P}^{1*}$ , and thus a line in  $\mathbb{C}\mathbb{P}^{3*}$ . Given a sphere  $\sigma \subset \mathbb{H}\mathbb{P}^1$  and corresponding line in  $\mathbb{C}\mathbb{P}^3$  there is a dual line in  $\mathbb{C}\mathbb{P}^{3*}$ . The twistor image under  $\mathbb{C}\mathbb{P}^{3*} \rightarrow \mathbb{H}\mathbb{P}^{1*}$  is then a 'dual' sphere,  $\sigma^*$ . Suppose that  $J$  is given in the coordinates  $v\mathbb{H} \oplus w\mathbb{H}$ , as above where  $a = [v]$ . Then,  $Jv = vN$  and  $Jw = vH + wR$  so that  $a \in \sigma$ . Now, define  $x \in \mathbb{H}^{2*}$  by  $x(v) = 0, x(w) = 1$ .  $J$  acts on elements of  $\mathbb{H}^2$  by precomposition. So, one computes:

$$(J^*x)v = x(Jv) = x(v)N = 0 \quad (2.23)$$

$$(J^*x)w = x(v)H + x(w)R = R.$$

So that,

$$J^*x = Rx. \quad (2.24)$$

Thus, if  $a \in \sigma$ , then  $a^* = [x] \in \sigma^*$ .

**Lemma 2.3.7** *Suppose that in coordinates  $\mathbb{H}^2 = v\mathbb{H} \oplus w\mathbb{H}$ , a two-sphere is given by*

$$J = \begin{pmatrix} N & H \\ 0 & R \end{pmatrix}. \quad (2.25)$$

*Then,  $Jv = vN$  implies  $J^*v^o = Rv^o$  where  $\mathbb{H}^{2*} = \mathbb{H}w^o \oplus \mathbb{H}v^o$ .*

Now, in order to determine tangency between two-spheres at a point in  $S^4 \cong \mathbb{H}\mathbb{P}^1$  one must characterize the tangent space of a given two-sphere inside the tangent space of  $\mathbb{H}\mathbb{P}^1$ . First, an elegant characterization of the tangent space at a point on  $S^4$ :

**Lemma 2.3.8** *Let  $L \in \mathbb{H}\mathbb{P}^1 \cong S^4$ , then  $T_L S^4 \cong \text{Hom}_{\mathbb{R}}(L, \mathbb{H}^2/L)$ .*

**Proof.** Let  $\psi \in \Gamma(\Sigma(\mathbb{H}\mathbb{P}^1))$  such that  $\tau(\psi(L)) = L$ . Then, for  $v \in T_L S^4$  define a map

$$v \mapsto (\psi(L) \rightarrow \pi_L d\psi(v)) \quad (2.26)$$

where  $\pi_L : L \rightarrow \mathbb{H}^2/L$ . ■

As  $J$  preserves the fiber  $L$ , it also acts on  $\mathbb{H}^2/L$ . Thus,  $J$  also induces a complex structure on  $\Sigma^*$ .

**Lemma 2.3.9** *Let  $L \in \sigma$ , an immersed two-sphere in  $S^4$  with associated  $J$ . Then,*

$$J\pi_L d = \pi_L dJ. \quad (2.27)$$

**Theorem 2.3.10** *Let  $\sigma$  and  $\sigma'$  be two-spheres in  $S^4$  with associated  $J$  and  $J'$  that intersect at a point  $L$ . Then,  $\sigma$  and  $\sigma'$  are touching at  $L$  iff  $J = J'$  restricted to  $L$  and  $\mathbb{H}^2/L$ .*

**Corollary 2.3.11** *Let  $\sigma$  and  $\sigma'$  be two-spheres in  $S^4$  with associated  $J$  and  $J'$  that intersect at a point  $L$ . Then,  $\sigma$  and  $\sigma'$  are tangent at  $L$  iff  $J$  and  $J'$  are given in coordinates centered at  $L$  by*

$$\begin{pmatrix} N & * \\ 0 & R \end{pmatrix}. \quad (2.28)$$

Now, employing projective duality in  $\mathbb{C}\mathbb{P}^3$ , it is possible to characterize tangency between two-spheres in terms of incidence properties of lines in  $\mathbb{C}\mathbb{P}^3$ . Suppose  $\sigma$  and  $\sigma'$  are two-spheres contained in  $\mathbb{H}\mathbb{P}^1$  and are tangent at  $L \in \sigma \cap \sigma'$ .

**Lemma 2.3.12** *Let  $J$  and  $J'$  represent spheres intersecting at a point  $L \in \mathbb{H}\mathbb{P}^1$ . Given in standard form with  $L$  at infinity,  $J = \begin{pmatrix} N & H \\ 0 & R \end{pmatrix}$  and  $J' = \begin{pmatrix} N' & H' \\ 0 & R' \end{pmatrix}$ , the lines in  $\mathbb{C}\mathbb{P}^3$  corresponding to  $\sigma$  and  $\sigma'$  and the twistor fiber of  $L$  are all incident to one point iff  $N = N'$ .*

The lines corresponding to  $\sigma$  and  $\sigma'$  span a projective (affine) plane in  $\mathbb{C}\mathbb{P}^3$  and each plane in  $\mathbb{C}\mathbb{P}^3$  contains exactly one twistor fiber. So, either  $L$  is contained in this plane or not.



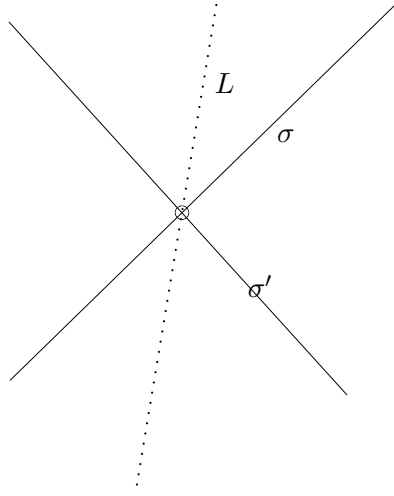

**Figure 9.** Two 2-spheres tangent at the twistor fiber  $L$ .

**Lemma 2.3.13** *Let  $J$  and  $J'$  represent spheres intersecting at a point  $L \in \mathbb{HP}^1$ . Given in standard form with  $L$  at infinity,  $J = \begin{pmatrix} N & H \\ 0 & R \end{pmatrix}$  and  $J' = \begin{pmatrix} N' & H' \\ 0 & R' \end{pmatrix}$ , the lines in  $\mathbb{CP}^3$  corresponding to  $\sigma^*$  and  $\sigma'^*$  and the twistor fiber of  $L^\circ$  are all incident to one point iff  $R = R'$ .*

**Theorem 2.3.14** *Let  $\sigma$  and  $\sigma'$  be two-spheres in  $\mathbb{HP}^1$  intersecting at a point  $L$ . Then,  $\sigma$  and  $\sigma'$  are tangent at  $L$  if and only if the twistor lifts of  $\sigma$  and  $\sigma'$  are incident and the twistor fiber of  $L$  lies in the projective plane in  $\mathbb{CP}^3$  defined by the twistor lifts of  $\sigma$  and  $\sigma'$ .*

**Proof.**  $\sigma$  and  $\sigma'$  are tangent iff  $N = N'$  and  $R = R'$ . Suppose  $\sigma$  and  $\sigma'$  are tangent, then their twistor lifts intersect the twistor fiber of  $L$  at one point. Hence, by projective duality, the dual twistor lifts of  $\sigma^*$  and  $\sigma'^*$  and the twistor fiber of  $L^\circ$  are planar in  $\mathbb{CP}^{3*}$ . But  $R = R'$  implies that they are incident at a point of  $L^\circ$ . Then, by duality again, the twistor lifts of  $\sigma$  and  $\sigma'$  and the twistor fiber over  $L$  are planar in  $\mathbb{CP}^3$  and are all mutually incident at one point as  $N = N'$ . This argument reverses exactly. ■

One has thus obtained a complete description of tangency in terms of the incidence properties of twistor lifts and twistor fibers in  $\mathbb{CP}^3$ . Now, this discussion may be refor-

ulated in terms of the Klein quadric:

**Theorem 2.3.15** *The set of two-spheres tangent at a point in  $\mathbb{H}\mathbb{P}^1$  is exactly parameterized by a line contained within  $Kl$  that intersects  $S^4 \subset Kl$  at exactly one real point.*

**Proof.** Observe that the set of projective lines incident to a point in  $\mathbb{C}\mathbb{P}^3$  and contained in a projective plane exactly describes a line in  $Kl$ . Since the associated spheres are assumed to be tangent, this set contains the twistor fiber over the intersection point which corresponds to a real point in  $Kl$ . ■

One says that two-spheres which are tangent, 'touch' at the point of tangency. However, not every line in  $Kl$  contains a real point or equivalently, given two lines which intersect in  $\mathbb{C}\mathbb{P}^3$  it is possible that the twistor fiber over the intersection point does not lie in the incident plane at the intersection point.

**Definition:** (HALF-TOUCHING SPHERES) Two-spheres whose twistor lifts intersect but are not tangent are called 'half-touching'.

**Theorem 2.3.16** *Half-touching spheres intersect in exactly two points.*

**Proof.** Consider two half-touching spheres. By construction they lie on a line contained in  $Kl$  which contains no twistor fiber. Every line in  $Kl$  is defined by the intersection of an  $\alpha$ -plane and a  $\beta$ -plane in  $\mathbb{C}\mathbb{P}^3$ . Then, every plane in  $\mathbb{C}\mathbb{P}^3$  contains exactly one twistor fiber so the twistor lifts of each half-touching sphere intersect those two twistor fibers given by the  $\alpha$  and  $\beta$  planes. ■

**Corollary 2.3.17** *Given a two-sphere  $S \subset S^4$  and two points on  $p, q \in S$ , there is a complex projective line of two-spheres half-touching  $S$  at  $p$  and  $q$ .*

It is not true that two spheres which intersect in  $S^4$  at two points are half-touching. Consider two-spheres  $s$  and  $\sigma$  which half-touch at a point  $q \in S^4$ . Now,  $sj$  is a copy of  $s$  in  $Kl$  with opposite orientation so that  $q$  is also a point in  $sj$ . Then, by Theorem 2.3.16,

$s$  and  $\sigma$  are incident at another point  $p$  which then must also be a point in  $sj$ . Thus,  $\sigma$  intersects  $sj$  in two points but by construction they do not half-touch.

Now, consider  $s$  and  $sj \in Kl$ : they correspond to two disjoint lines in  $\mathbb{CP}^3$ . The map  $j$  associates to each point in  $q \in s \subset \mathbb{CP}^3$  a corresponding point  $qj \in sj$ , where  $\{q, qj\}$  spans a twistor fiber. Thus, there is a complex one-parameter family of lines defined by the pair  $\{s, sj\}$ . This family resembles a nondegenerate quadric in  $\mathbb{CP}^3$ , however,  $j$  is an anti-linear map rather than a linear map. That this family does not define a quadric may be deduced from the fact that  $\{s, sj\}$  do not lie in a transverse one-parameter family. It is clear that any complex projective line which is incident to every twistor fiber of the family  $\{s, sj\}$  must map by twistor projection to the set  $s \subset S^4$ . But, contradicting this is that  $s$  has a unique, up to orientation, twistor lift in  $\mathbb{CP}^3$ .

However, there is a two-dimensional complex projective quadric associated to  $\{s, sj\}$  but it is contained in  $Kl$ . This quadric is defined by the intersection of  $Kl$  with  $s^\perp \cap sj^\perp$  choosing suitable representatives for  $s$  and  $sj \in Kl \subset \mathbb{CP}^5$  in  $\mathbb{C}^6$ . This quadric parameterizes all lines in  $\mathbb{CP}^3$  incident to  $s$  and  $sj$ , each line being defined by a pair of points on  $s$  and  $sj$  respectively.

**Theorem 2.3.18** *Let  $Q_s \subset Kl$  be the quadric defined by lines in  $\mathbb{CP}^3$   $\{s, sj\}$ , then  $Q_s$  is ruled by two families of lines.*

**Proof.**

Let  $q$  be a point on  $s \subset \mathbb{CP}^3$ . The points of  $Q_s$  correspond to lines in  $\mathbb{CP}^3$  which are incident to  $s$  and  $sj$ . Now, consider the plane in  $\mathbb{CP}^3$  defined by all lines through  $q$  and incident to  $sj$ . By construction this defines a line  $l_q$  contained in  $Q_s$ . Further, if  $p$  is another point on  $s$ , the corresponding line in  $Q_s$  is disjoint from  $l_q$ . Thus, the points of  $s$  parameterize a family of disjoint lines in  $Q_s$ . Now, consider a point  $pj$  on  $sj$ . The same construction defines another family of disjoint lines each of which contains the point defined by  $\{pj, q\}$  for  $q \in s$ . Thus, each line in the family parameterized by  $sj$  is incident to every line in the family defined by  $s$ . ■

Note that each line in  $Q_s$  contains a twistor fiber and thus corresponds to a family of two-spheres tangent at the point in  $S^4$  corresponding to the twistor fiber. However, for a given  $l_q \subset Q_s$ ,  $\sigma \in l_q$  half-touches  $s$  at  $q$  by construction. Thus, an element of  $Q_s$  is either the twistor fiber of a point in  $s$  or a two-sphere in  $S^4$  which half-touches  $s$ . One notices further that each  $\sigma \in Q_s$  also half-touches  $sj$  :

**Corollary 2.3.19** *The quadric  $Q_s \subset Kl$  consists of those spheres which half-touch both  $s$  and  $sj$ .*

### 2.3.2 Circles in $S^4$

It is a classical theorem that three points define a circle, this may be seen simply by defining a Möbius transformation indentifying these three points with  $\{0, 1, \infty\} \subset \mathbb{R} \subset \mathbb{H}$ . Then  $\mathbb{R} \cup \{\infty\}$  is the circle.

**Lemma 2.3.20** *Given three points in space there is exactly one circle incident to all three.*

Let  $L, M, N \in \mathbb{H}\mathbb{P}^1$ . Now, choose representatives and a change of basis for  $\mathbb{H}^2$  so that  $L = \begin{bmatrix} 1 \\ 0 \end{bmatrix}$ ,  $M = \begin{bmatrix} 0 \\ 1 \end{bmatrix}$ , and  $N = \begin{bmatrix} 1 \\ 1 \end{bmatrix}$ . Thus, in the associated affine chart on  $\mathbb{H}\mathbb{P}^1$  the circle through  $\{L, M, N\}$  is identified with the real line in  $\mathbb{H}$ . Consider now the three twistor lines in  $\mathbb{C}\mathbb{P}^3$  corresponding to  $\{L, M, N\}$ . Since each is a twistor fiber they must all be mutually disjoint. Now, three disjoint lines in  $\mathbb{C}\mathbb{P}^3$  correspond to three points in  $Kl \subset \mathbb{C}\mathbb{P}^5$ . Three points in  $\mathbb{C}\mathbb{P}^5$  span a two-plane hence the intersection of  $Kl$  with this two plane is a one dimensional complex quadric. Since the real set of this quadric contains three points it must contain the circle in  $S^4$  through those three points. Thus, three points define a circle inside  $S^4 \subset Kl \subset \mathbb{C}\mathbb{P}^5$ .

Consider the question: What is the space of two-spheres incident to a circle? If the circle is identified with the real line in  $\mathbb{H}$ , it is clear that this set is identified with the

space of real two-planes in  $\mathbb{H}$  that contain the real axis. This set is double covered by the unit sphere in  $Im\mathbb{H}$  by the antipodal map and is thus parameterized by  $\mathbb{RP}^2$ . One may recover this result by considering the space of *oriented* two-spheres incident to a circle. This is given in  $\mathbb{CP}^3$  by the set of lines incident to three twistor-fibers defining a circle.

**Lemma 2.3.21** *Let  $\{L, M, N\}$  be three disjoint lines in  $\mathbb{CP}^3$ . For each  $p \in L$  there is a unique line incident to  $p$  which is also incident to  $M$  and  $N$ .*

**Proof.** There is a unique plane defined by  $\{p, M\}$  given by all lines through  $p$  also incident to  $M$ . Then,  $N$  either lies in  $\{p, M\}$  or intersects in exactly one point,  $x$ . But,  $N$  cannot be contained in  $\{p, M\}$  else it would intersect  $M < \{p, M\}$ . Hence, the unique line is given by  $\{p, x\}$ . ■ If  $\{L, M, N\}$  are twistor fibers (or any one of them) the line

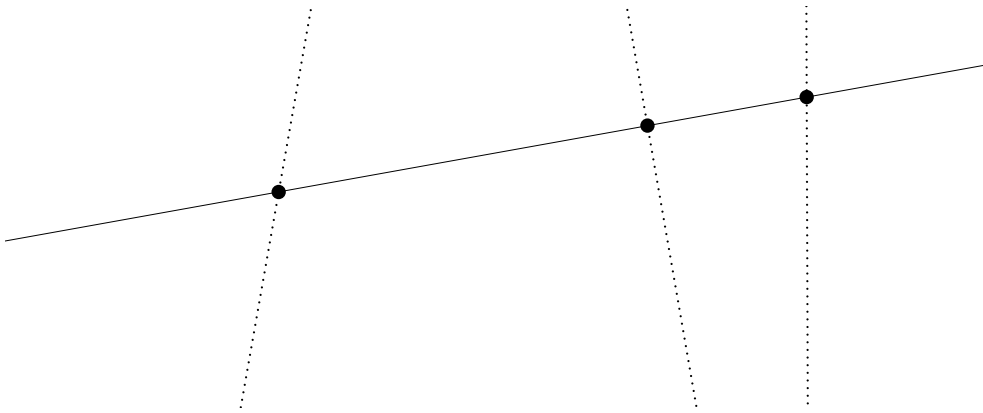

**Figure 10. Three Points and Incident 2-Sphere**

given in the previous lemma must correspond to a two-sphere in  $\mathbb{HP}^1$  as it is incident to a twistor fiber.

**Lemma 2.3.22** *Three disjoint lines in  $\mathbb{CP}^3$  define a nondegenerate complex quadric surface in  $\mathbb{CP}^3$ .*

**Proof.** This is a doubly ruled surface formed by two families of mutually disjoint lines one of which contains the original three lines and the other all of the lines incident to each of the original three. ■

This can be restated in terms of the geometry of the Klein quadric. Given the lines  $\{L, M, N\}$ , a line  $x$  incident to each of them will satisfy  $\langle x, L \rangle_K = \langle x, M \rangle_K = \langle x, N \rangle_K = 0$  for any representatives. Thus, since  $\{L, M, N\}$  span a plane in  $\mathbb{C}\mathbb{P}^5$ ,  $x$  is in the three dimensional normal space to that generated by  $\{L, M, N\}$ . This normal space is three-dimensional and so it defines a projective plane in  $\mathbb{C}\mathbb{P}^5$  whose intersection with  $Kl$  is given as a one-dimensional quadric. Thus, given three twistor-fibers the space of lines incident to all three is parametrized by points in a one-dimensional quadric contained in  $Kl$ . Note that this family does not include the set of points incident to that circle.

**Lemma 2.3.23** *Three disjoint lines in  $\mathbb{C}\mathbb{P}^3$  define two disjoint nondegenerate one-dimensional complex quadrics in  $Kl$ .*

**Proof.** Three lines  $\{L_1, L_2, L_3\}$  in  $\mathbb{C}\mathbb{P}^3$  define three points in  $Kl \subset \mathbb{C}\mathbb{P}^6$  which then define a projective plane in  $\mathbb{C}\mathbb{P}^6$ . Since these three lines are disjoint, corresponding representatives in  $\wedge^2\mathbb{C}^4 \cong \mathbb{C}^6$  have non-zero products and are self-null since they represent lines. Hence, computing the restriction of the bilinear form  $\langle, \rangle_K$  one obtains that the intersection of the projective plane  $\{L_1, L_2, L_3\} \cap Kl$  is a non-degenerate one-dimensional complex quadric.

Now  $\{L_1, L_2, L_3\}$  defines a 3-dimensional subspace of  $\wedge^2\mathbb{C}^4$ . Consider the perpendicular space with respect to  $\langle, \rangle_K$ . As,  $\{L_1, L_2, L_3\} \oplus \{L_1, L_2, L_3\}^\perp \cong \wedge^2\mathbb{C}^4$ , the restriction of the non-degenerate form  $\langle, \rangle_K$  to  $\{L_1, L_2, L_3\}^\perp$  is also nondegenerate. Hence  $\{L_1, L_2, L_3\}^\perp \cap Kl$  is a non-degenerate one-dimensional quadric disjoint from  $\{L_1, L_2, L_3\} \cap Kl$  ■

The points of the normal quadric correspond to all lines in  $\mathbb{C}\mathbb{P}^3$  which intersect the three original lines.

**Theorem 2.3.24** *The point set of a circle in  $S^4$  is given as the real part of a non-degenerate one-dimensional quadric contained within the Klein quadric.*

**Proof.** A circle is defined by three points. The three corresponding twistor-fibers define a projective two-plane in  $\mathbb{C}\mathbb{P}^5$  whose intersection with  $Kl$  is nondegenerate and contains

the representatives of the original three points. ■

**Theorem 2.3.25** *The space of oriented two-spheres (of non-zero radius) incident to a circle in  $S^4$  is parameterized by a nondegenerate complex one-dimensional quadric.*

**Proof.** A circle in  $S^4$  defined by three points. The corresponding twistor-fibers are three disjoint projective lines in  $\mathbb{C}\mathbb{P}^3$  defining two disjoint one-dimensional quadrics in  $Kl$ . One quadric contains the twistor-fibers making the point set of the circle, the normal quadric defines every incident two-sphere to the original three points as no two twistor fibers may intersect. Since each two-sphere of the normal quadric contains the original three points it contains the circle defined by those three points. ■

Note that the anti-linear map on  $\bigwedge^2 \mathbb{C}^4 \cong \mathbb{C}^6$  induced by right multiplication by  $j$  on  $\mathbb{C}^4 \cong \mathbb{H}^2$  and restricted to the quadric of incident two-spheres is compatible with the anti-podal map.

Now, as the set of real points of a circle lie on a one-dimensional complex quadric contained in  $Kl$ , one may define a cross-ratio on them via the Steiner theorem (Tabachnikov, Pedoe?).

**Lemma 2.3.26 (Steiner Theorem)** *Let  $Q \subset \mathbb{C}\mathbb{P}^2$  be a one-dimensional irreducible projective quadric. Let  $a \in Q$  and let  $S_a$  be the set of projective lines contained in  $\mathbb{C}\mathbb{P}^2$  and incident to  $a$ . Define  $\pi_a : Q \rightarrow S_a$  by  $x \mapsto \{x, a\}$ , the line spanned by  $x$  and  $a$ . Now, the set of lines in a projective plane incident to a point defines a projective line so that  $S_a \cong \mathbb{C}\mathbb{P}^1$ . Let  $b \in Q$ , then  $\pi_b \pi_a^{-1} : \mathbb{C}\mathbb{P}^1 \rightarrow \mathbb{C}\mathbb{P}^1$  is a projective transformation.*

Thus, one may define the cross-ratio of  $\{a, b, c, d\} \subset Q$  by computing the cross-ratio of their representatives in  $\mathbb{C}\mathbb{P}^1$ . It remains to be shown that if  $\{a, b, c, d\}$  lie on a circle then this cross-ratio is identical to the complex cross-ratio defined in  $\mathbb{H}\mathbb{P}^1$ . As these points are circular, their complex cross-ratio is a real number and invariant under quaternionic projective transformations.

The equivalence of the Steiner and complex cross-ratios is obtained by mapping the circle into  $Kl$  via twistor projection and, noting that the image lies in a one-dimensional quadric, computing the Steiner cross-ratio of points on the image of the circle. As the complex cross-ratio of circular points is invariant under projective transformations of  $\mathbb{HP}^1$ , given the circular points  $\{p, p_1, p_2, p_3\} \subset S^4$  one may choose coordinates on  $\mathbb{HP}^1 \cong S^4$  so that those points are  $\{\infty, 1, 0, \lambda\} \subset \mathbb{R} \subset \mathbb{H}$ . Computing the complex cross-ratio one obtains

$$[\infty, 1, 0, \lambda] = \lambda, \quad (2.29)$$

where

$$\infty = \begin{bmatrix} 1 \\ 0 \end{bmatrix}, 1 = \begin{bmatrix} 1 \\ 1 \end{bmatrix}, 0 = \begin{bmatrix} 0 \\ 1 \end{bmatrix}, \lambda = \begin{bmatrix} \lambda \\ 1 \end{bmatrix}. \quad (2.30)$$

Now, writing  $\mathbb{H} = \mathbb{C} \oplus \mathbb{C}j$  one associates  $\mathbb{H}^2 \rightarrow \mathbb{C}^4$  by  $(a + bj, c + dj) \mapsto (a, \bar{b}, c, \bar{d})$  so that

$$\begin{pmatrix} 1 \\ 0 \end{pmatrix} \mapsto e_1 = \begin{pmatrix} 1 \\ 0 \\ 0 \\ 0 \end{pmatrix}, \begin{pmatrix} 0 \\ 1 \end{pmatrix} \mapsto e_3 = \begin{pmatrix} 0 \\ 0 \\ 1 \\ 0 \end{pmatrix}, \begin{pmatrix} 1 \\ 1 \end{pmatrix} \mapsto \begin{pmatrix} 1 \\ 0 \\ 1 \\ 0 \end{pmatrix}, \begin{pmatrix} \lambda \\ 1 \end{pmatrix} \mapsto \begin{pmatrix} \lambda \\ 0 \\ 1 \\ 0 \end{pmatrix} \quad (2.31)$$

and

$$\begin{pmatrix} 1 \\ 0 \end{pmatrix} j \mapsto e_2 = \begin{pmatrix} 0 \\ 1 \\ 0 \\ 0 \end{pmatrix}, \begin{pmatrix} 0 \\ 1 \end{pmatrix} j \mapsto e_4 = \begin{pmatrix} 0 \\ 0 \\ 0 \\ 1 \end{pmatrix}, \begin{pmatrix} 1 \\ 1 \end{pmatrix} j \mapsto \begin{pmatrix} 0 \\ 1 \\ 0 \\ 1 \end{pmatrix}, \begin{pmatrix} \lambda \\ 1 \end{pmatrix} j \mapsto \begin{pmatrix} 0 \\ \lambda \\ 0 \\ 1 \end{pmatrix} \quad (2.32)$$



since  $\lambda$  is real. Further, abusing notation,

$$\begin{aligned}
\begin{pmatrix} 1 \\ 0 \end{pmatrix} \wedge \begin{pmatrix} 1 \\ 0 \end{pmatrix} j &= e_1 \wedge e_2, \\
\begin{pmatrix} 0 \\ 1 \end{pmatrix} \wedge \begin{pmatrix} 0 \\ 1 \end{pmatrix} j &= e_3 \wedge e_4, \\
\begin{pmatrix} 1 \\ 1 \end{pmatrix} \wedge \begin{pmatrix} 1 \\ 1 \end{pmatrix} j &= (e_1 + e_3) \wedge (e_2 + e_4),
\end{aligned} \tag{2.33}$$

and,

$$\begin{aligned}
\begin{pmatrix} \lambda \\ 1 \end{pmatrix} \wedge \begin{pmatrix} \lambda \\ 1 \end{pmatrix} j &= (e_1 \lambda + e_3) \wedge (e_2 \lambda + e_4) \\
&= e_1 \wedge e_2 \lambda^2 + e_1 \wedge e_4 \lambda + e_2 \wedge e_3 (-\lambda) + e_3 \wedge e_4.
\end{aligned} \tag{2.34}$$

so that with respect to the basis

$$\{e_1 \wedge e_2, e_1 \wedge e_3, e_1 \wedge e_4, e_2 \wedge e_3, e_2 \wedge e_4, e_3 \wedge e_4\} \tag{2.35}$$

one obtains the points in  $\mathbb{CP}^5 = \mathbb{P}(\wedge^2 \mathbb{C}^4)$  :

$$\begin{bmatrix} 1 \\ 0 \\ 0 \\ 0 \\ 0 \\ 0 \\ 0 \end{bmatrix}, \begin{bmatrix} 0 \\ 0 \\ 0 \\ 0 \\ 0 \\ 0 \\ 1 \end{bmatrix}, \begin{bmatrix} 1 \\ 0 \\ 1 \\ -1 \\ 0 \\ 0 \\ 1 \end{bmatrix}, \begin{bmatrix} \lambda^2 \\ 0 \\ \lambda \\ -\lambda \\ 0 \\ 0 \\ 1 \end{bmatrix}. \tag{2.36}$$

Now, writing

$$\begin{pmatrix} \lambda^2 \\ 0 \\ \lambda \\ -\lambda \\ 0 \\ 1 \end{pmatrix} = \begin{pmatrix} 0 \\ 0 \\ 0 \\ 0 \\ 0 \\ 1 \end{pmatrix} + \left( \begin{pmatrix} 1 \\ 0 \\ 1 \\ -1 \\ 0 \\ 1 \end{pmatrix} - \begin{pmatrix} 0 \\ 0 \\ 0 \\ 0 \\ 0 \\ 1 \end{pmatrix} \right) \lambda + \begin{pmatrix} 1 \\ 0 \\ 0 \\ 0 \\ 0 \\ 0 \end{pmatrix} \lambda^2 = o + b\lambda + a\lambda^2 \quad (2.37)$$

one observes that the image of the circle in  $S^4$  is, with respect to the projective plane defined by the span of  $\{o, b, a\}$ , given in these coordinates by a parabola. The Steiner cross-ratio is can be calculated by a one-point projection from the parabola onto a straight line. Choose the axis of the projection to be the point  $[o + b + a]$  and the line to be "b" axis with coordinates so that  $o$  is 0 one computes that:

$$a \mapsto 1, o \mapsto 0, o + b + a \mapsto \frac{1}{2}, o + b\lambda + a\lambda^2 \mapsto \frac{\lambda}{\lambda + 1}. \quad (2.38)$$

and finally

$$\left[1, \frac{1}{2}, 0, \frac{\lambda}{\lambda + 1}\right] = \lambda. \quad (2.39)$$

Thus, the quaternionic cross-ratio and the Steiner cross-ratio agree for circular points in  $S^4$ . In fact, the Steiner cross-ratio and the quaternionic cross-ratio are equivalent for all values.

**Theorem 2.3.27** *Let  $\{a, b, c, d\} \subset \mathbb{H}\mathbb{P}^1$  such their complex cross-ratio is real valued, then the Steiner cross-ratio with respect to their representatives in  $Kl$  is equal to their complex cross-ratio.*

The Steiner cross-ratio may take on complex values on the one dimensional subquadric contained in  $Kl$  defined by a circle in  $S^4$  but there is no Steiner cross-ratio defined for points in  $S^4$  whose complex cross-ratio is non-real i.e. those not lying on a circle,

as their representatives in  $Kl$  do not lie on a one-dimensional sub-quadric. However, the Steiner cross-ratio is defined for points in  $Kl$  that correspond to two-spheres in  $S^4$  provided they lie on a one-dimensional sub-quadric and regardless of whether that quadric contains any real points. One might ask whether there is association between points in  $Kl$  with complex-valued Steiner cross-ratio and points in  $\mathbb{HP}^1$ . A partial answer is given by the computation proving Theorem 2.3.27. Notice that, with respect the affine chart for  $\mathbb{HP}^1$  which associates the circular points  $\{p_1, p_2, p_3, p_4\}$  with  $\{\infty, 1, 0, \lambda\}$ ,  $\lambda$  may take on values in  $\mathbb{C} \subset \mathbb{H}$ . The cross-ratio formula is identical for complex-values which then parameterize  $\mathbb{C} \subset \mathbb{H}$ .

Another way of interpreting this is that the choice of affine chart on  $\mathbb{HP}^1$  also determines a two-sphere  $S$ , identified with  $\mathbb{C} \subset \mathbb{H}$ , incident to the circle  $\Xi$  identified with  $\mathbb{R} \subset \mathbb{C} \subset \mathbb{H}$ . Now, as  $S$  is incident to  $\Xi$ , it's representative in  $Kl$  lies in the perpendicular space and perpendicular quadric of the quadric in  $Kl$  defined by the circle. Let  $Q_\Xi$  denote the quadric in  $Kl$  containing the circle  $\Xi$  as it's real set. Each point in  $Q_\Xi$  corresponds to a line in  $\mathbb{CP}^3$  which intersects the line in  $\mathbb{CP}^3$  corresponding to  $S$ . Then, as  $Sj$  is also incident to  $\Xi$ , each point in  $Q_\Xi$  corresponds to a line in  $\mathbb{CP}^3$  which intersects the line in  $\mathbb{CP}^3$  corresponding to  $Sj$ . That is,  $Q_\Xi$  lies in the two-dimensional subquadric  $Q_S \subset Kl$  defined by  $span_{\mathbb{C}}\{S, Sj\}^\perp$ . So, with respect to this affine chart on  $\mathbb{HP}^1$  the following may be obtained:

**Theorem 2.3.28** *Let  $\lambda \in \mathbb{C}$ , then the line representatives of the point  $S_\lambda$  in  $Q_\Xi$  with Steiner cross-ratio  $\lambda$ , the point in  $S$  with cross-ratio  $\lambda$  and,  $S$  are all incident at the same point in  $\mathbb{CP}^3$  and are not all contained in a projective plane.*

**Proof.**

Since it has already been established that the line corresponding to  $S$  is incident to the line corresponding to  $S_\lambda$  and by construction the point  $\lambda$  is in  $S$  (and thus has twistor fiber incident to  $S$ ), it remains to show that the twistor fiber of  $\lambda$  and  $S_\lambda$  are incident. This may be shown by computing the wedge of their representatives in  $Kl$ . If it is zero

then the corresponding lines are incident.

For points in  $S$ , that is, for complex values of  $\lambda$ , (2.34) becomes

$$\begin{aligned} \begin{pmatrix} \lambda \\ 1 \end{pmatrix} \wedge \begin{pmatrix} \lambda \\ 1 \end{pmatrix} j &= (e_1\lambda + e_3) \wedge (e_2\bar{\lambda} + e_4) \\ &= e_1 \wedge e_2 |\lambda|^2 + e_1 \wedge e_4 \lambda + e_2 \wedge e_3 (-\bar{\lambda}) + e_3 \wedge e_4. \end{aligned} \tag{2.40}$$

Then, a straightforward computation shows that

$$((e_1\lambda + e_3) \wedge (e_2\bar{\lambda} + e_4)) \wedge ((e_1\lambda + e_3) \wedge (e_2\lambda + e_4)) = 0.$$

■

The conclusion one draws from Theorem 2.3.28 is that, relative to the circle  $\Xi$  and associated sphere  $S$  identified with  $\mathbb{C}$ , the points in  $S$  corresponding to complex  $\lambda$  exactly correspond to the points in  $Q_\Xi$  with complex Steiner cross-ratio  $\lambda$ . Another way of saying this is that there is an exact correspondence between  $S$  and the complex one-dimensional subquadric  $Q_\Xi$ .

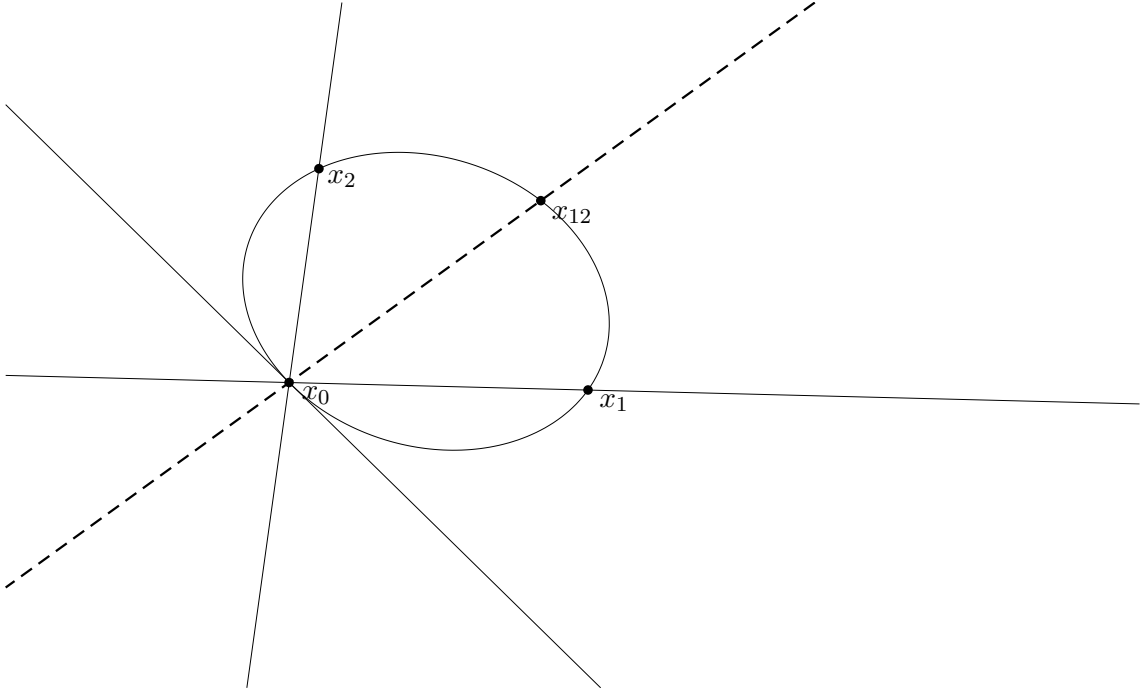

**Figure 11. Construction of a fourth point using the Steiner cross-ratio.**

Now, given three points lying on an irreducible one-dimensional projective quadric, choosing  $\lambda \in \mathbb{C}$  defines a fourth point satisfying the condition that the Steiner cross-ratio of all four is  $\lambda$ . Let  $\{x_0, x_1, x_2\} \subset Kl$  so that  $Q = \text{span}_{\mathbb{C}}\{x_0, x_1, x_2\} \cap Kl$  is an irreducible quadric. Now, choose representatives lying in an affine chart for all points. With respect to these coordinates let  $x_{12} \in \text{span}_{\mathbb{C}}\{x_0, x_1, x_2\}$  so that

$$x_{12} = t_0x_0 + t_1x_1 + t_2x_2. \quad (2.41)$$

As all basis elements are null,  $Q$  must be given in the affine chart  $t_0 = 1$  by an equation of the form:

$$a_{01}t_1 + a_{02}t_2 + a_{12}t_1t_2 = 0.$$

Now, consider  $S_{x_0}$ , the set of lines through  $x_0$ . The representatives of  $\{x_0, x_1, x_2\}$  are given by equations:

$$\begin{aligned} a_{01}t_1 + a_{02}t_2 &= 0 \\ t_2 &= 0 \\ t_1 &= 0, \end{aligned} \quad (2.42)$$

where the first equation is that of the tangent line to  $Q$  at  $x_0$ . Thus, choosing an affine chart for  $\mathbb{CP}^1$ ,  $\{x_0, x_1, x_2\}$  are represented by

$$\left\{ \begin{bmatrix} 1 \\ \frac{a_{02}}{a_{01}} \end{bmatrix}, \begin{bmatrix} 0 \\ 1 \end{bmatrix}, \begin{bmatrix} 1 \\ 0 \end{bmatrix} \right\},$$

so that

$$cr[x_0, x_1, x_{12}, x_2] = cr\left[\frac{a_{02}}{a_{01}}, \infty, z, 0\right] = \lambda$$

determines

$$z = \lambda \frac{a_{02}}{a_{01}}$$

and  $x_{12}$  is given by the intersection of the line  $a_{01}t_1 + \lambda a_{02}t_2 = 0$  and  $Q$ . Hence, in the affine chart  $t_0 = 1$

$$\begin{aligned} x_{12} &= x_0 + t_1x_1 + t_2x_2, \\ t_1 &= \frac{a_{02}}{a_{12}}(\lambda - 1) \\ t_2 &= \frac{a_{01}}{a_{12}} \frac{1 - \lambda}{\lambda}. \end{aligned} \tag{2.43}$$

Finally, one notes that in terms of eq. (2.41) the representative of  $x_{12}$  in the affine chart is given by

$$x_{12} = x_0 + \frac{t_1}{1 + t_1 + t_2} \Delta_1 x + \frac{t_2}{1 + t_1 + t_2} \Delta_2 x. \tag{2.44}$$

## 2.4 The contact geometry of the Klein quadric

The incidence geometry of the Klein quadric is given by the set of incidence properties of all the projective points, lines, and planes contained in  $Kl$ . Since points and lines in  $Kl$  correspond to two-spheres in  $S^4$  and pencils of two-spheres in contact (touching or half-touching,) the contact geometry of two-spheres in  $S^4$  can be defined in terms of incidence geometry i.e. "two-spheres are touching or half-touching in  $S^4$  if and only if the corresponding two points in  $Kl$  define a line contained in  $Kl$ ."

**Definition:** Let  $s_1$  and  $s_2$  be two-spheres in  $S^4$ , then  $s_1$  and  $s_2$  will be said to be in *contact* if their representatives lie on a line contained in  $Kl$ .

Consider a point  $[p]$  on a line  $l \subset \mathbb{C}\mathbb{P}^3$  corresponding to a two-sphere in  $S^4$ . By twistor projection  $p$  corresponds to a point in  $S^4$ ; hence one may associate a line, the twistor fiber of  $p$ , to  $[p]$ . By construction then the plane spanned by the twistor fiber  $[p]$  and  $l$  defines a line in  $Kl$ . Thus the points of a two-sphere themselves are in contact with the two-sphere and one may recover the set of points in  $Kl$  making up a two-sphere in  $S^4 \subset Kl$  as the real part of the set of points in contact with that two-sphere.

**Theorem 2.4.1** *Let  $s \in Kl$  represent a two-sphere in  $S^4$ , then the set of real points of  $Kl$  with respect to  $j$  defines a two-sphere in  $S^4 \subset Kl$ .*

**Proof.** Let  $s \in Kl$  represent a two-sphere in  $S^4$ , then the set of points in contact with  $s$  is given by  $s^\perp \cap Kl$ , a 3-dimensional subset of  $Kl$ . Since  $s$  corresponds to a two-sphere it has real points in contact, hence the real part of  $s^\perp$  is non-empty. Now, consider a real point in  $s^\perp$ . The twistor fiber corresponding to this point is also incident to  $sj$ . Hence the set of real points in  $s^\perp$  is contained in  $s^\perp \cap sj^\perp \cap Kl$ , a 2-dimensional sub-quadric of  $Kl$ .

■

**Theorem 2.4.2** *Given four two-dimensional spheres in general position in  $\mathbb{P}(\wedge^2 \mathbb{C}^4) \cong \mathbb{C}\mathbb{P}^5$  there is exactly one unoriented sphere (half)touching each of the spheres.*

**Proof.** Four non-planar spheres, as points in  $Kl$ , span a three dimensional projective space in  $\mathbb{C}\mathbb{P}^5$ . This space is the projective image of a four dimensional subspace  $V < \mathbb{C}^6$ . Two lines intersect in  $\mathbb{C}\mathbb{P}^3$  they are orthogonal with respect to  $\langle, \rangle_K$ . Then  $\dim(V^\perp) = 2$ . Now, either  $\mathbb{P}(V^\perp) \subset Kl$  or  $\mathbb{P}(V^\perp) \cap Kl = \{S, Sj\}$ . Exclude the former as a degenerate configuration. ■ Note that one recovers from this another proof of the result that four points define a unique unoriented sphere if they do not all lie on a circle (i.e. their representatives in  $Kl$  are non-planar.)

**Corollary 2.4.3** *If four points in  $S^4$  are circular, then they are planar in  $Kl$ .*

**Proof.** Consider four points incident to a circle in  $S^4 \subset Kl \subset \mathbb{C}\mathbb{P}^5$ . Suppose the points are in general position in  $Kl$ , they then span a three-dimensional projective space. But, two-spheres incident at a common circle cannot be touching or half-touching hence the set of spheres in contact cannot be a projective line. Then, there is a one-parameter family of two-spheres incident to a circle contradicting the assumption that they are in general position. ■

**Corollary 2.4.4** *If four points in  $S^4 \subset Kl$  are in general position, then there is exactly one two-sphere incident to all of them.*

Consider the previous description of a circle defined by three points in  $S^4$  by the quadric in  $\mathbb{CP}^3$  determined by the twistor lines corresponding to those three points. The two rulings of this quadric by projective lines correspond to two disjoint one-dimensional quadrics contained in  $Kl$ . One family contains all of the 'points' of the circle as twistor lines in  $\mathbb{CP}^3$ . But then the other family can contain no 'points' as each member of one family is incident to all members of the other family.

**Theorem 2.4.5** *Given two twistor fibers  $p$  and  $q$ . Choose a line  $S$  in  $\mathbb{CP}^3$  incident to  $p$ . Then  $\{p, S\}$  defines a line in  $Kl$  corresponding to all two-spheres tangent to  $S$  at  $p$  so that there is exactly one element of  $\{p, S\}$  touching  $q$ .*

**Proof.** Denote by  $[p_s]$  the point intersection of  $p$  and  $S$  in  $\mathbb{CP}^3$ . The pair  $\{p, S\}$  defines a projective plane in  $\mathbb{CP}^3$  so that the set consisting of every line contained in this plane and incident to  $p$  at  $[p_s]$  defines a line in  $Kl$  by (previous result.) Thus, as  $p$  and  $q$  are disjoint, the projective line  $q$  intersects projective plane  $\{p, S\}$  at exactly one point,  $[q_s]$ . Define  $S_i$  as the line  $\{[p_s], [q_s]\}$ . Then  $S_i$  is contained in  $\{p, S\}$  and incident to  $q$  by construction.

■

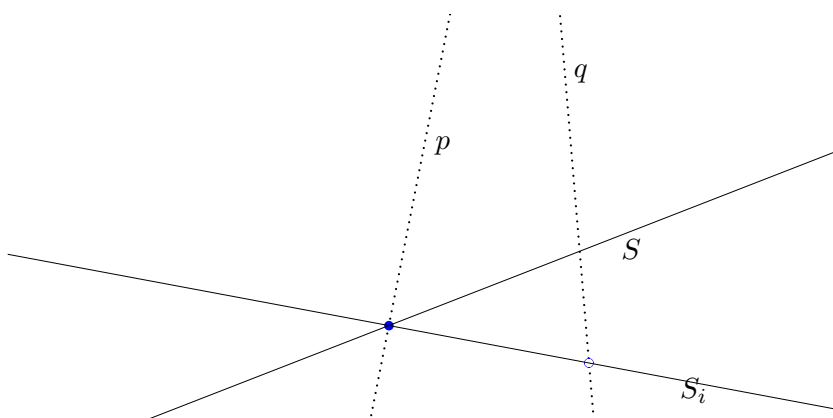

**Figure 12.** Given the point  $p$  and sphere  $S$ , there is a unique sphere  $S_i$  through  $q$  and incident to  $S$ .



**Corollary 2.4.6** *Let  $p$  be a point in  $S^4$  and  $s$  a two-sphere in  $S^4$  incident to  $p$ . Then through any other point  $q$  in  $S^4$  there is exactly one two-sphere in  $S^4$  incident to  $q$  and tangent to  $s$  at  $p$ .*

**Corollary 2.4.7** *Let  $s_1$  and  $s_2$  be two-spheres in  $S^4$ . Then, for each point on  $s_1$  there is a unique sphere in contact with  $s_1$  at that point and in contact with  $s_2$ .*

**Theorem 2.4.8** *Let  $\sigma \in Kl$  be a point and  $\Pi$  be a line disjoint from  $\sigma$  contained in  $Kl$ , then there is a unique  $s \in \Pi$  such that  $\{\sigma, s\}$  spans a line contained in  $Kl$ .*

**Proof.**

The set  $\sigma^\perp$  is a hyperplane in  $\mathbb{CP}^5$ . As  $\Pi$  is disjoint from  $q$ ,  $\Pi$  cannot be contained in  $\sigma^\perp$ . Hence, the intersection of the line and the hyperplane is a point. Let  $s \in \Pi \cap \sigma^\perp$ , then  $\{\sigma, s\}$  spans a line contained in  $Kl$ . ■

Note that this result generalizes Theorem 2.4.5.

Choose four points  $\{p, p_1, p_2, p_{12}\} \subset S^4$  and order them cyclically. By choosing a two-sphere  $\sigma$  incident to  $p$  one may now apply the results of Theorem 2.4.5 to associate a line in  $Kl$  to each point. The question remains whether the results of the theorem 'close' when followed around the cycle e.g., whether extending the result of Theorem 2.4.5 from  $p_{12}$  to  $p$  recovers the line in  $Kl$  spanned by  $\{p, \sigma\}$ . It will be shown that this procedure closes around the cycle if and only if the four points are all incident to a circle.

**Theorem 2.4.9** *Consider  $\{p, p_1, p_2, p_{12}\} \subset S^4$  all incident to a circle. Choose a contact line in  $Kl$  incident to  $p$ , then Theorem 2.4.5 defines contact lines mutually incident with respect to the cyclic ordering and closing around the cycle.*

**Proof.**

Let  $l = \{p, \sigma\}$ . Since the points are circular they are contained in a plane  $\Pi \subset \mathbb{CP}^5$  by Corollary 2.4.3. Thus,  $\{l, \Pi\}$  defines a three-dimensional linear space in  $\mathbb{CP}^5$ . Now, Theorem 2.4.5 defines lines  $l_1$  and  $l_2$  incident to  $p_1$  and  $p_2$  respectively. By construction

$l_1, l_2 \subset \{l, \Pi\}$ . Now, by Theorem 2.4.5,  $l_1$  and  $l_2$  induce lines in  $Kl$  at  $p_{12}$ . But,  $\{p_{12}, l_1\}$  and  $\{p_{12}, l_2\}$  are two planes contained in  $\{l, \Pi\}$ , hence they intersect in a line incident to  $\{l_1, p_{12}, l_2\}$ . Since this line is incident to  $\{l_1, l_2\}$  by the uniqueness in Theorem 2.4.5 it must be equal to the lines induced by  $l_1$  and  $l_2$ . ■

Notice that each line intersects its two neighbors. (figure) Now the converse to this Theorem 2.4.9 is not true. That is: given four points in  $S^4$  not lying on a circle, one may construct a cycle of intersecting contact lines in  $Kl$ .

**Theorem 2.4.10** *Let  $\{q, q_1, q_2, q_3\}$  be four points in  $S^4$  in general position so that  $q$  denotes the intersection of the associated twistor fiber with the unique sphere upon which they are all incident. By choosing an initial contact line as  $l = \{q, sj\} \subset Kl$ , Theorem 2.4.5 defines a unique set  $\{l, l_1, l_2, l_3\}$  of cyclically incident contact lines.*

**Proof.**

Given  $l = \{q, sj\}$ , by Theorem 2.4.5,  $l_1 = \{q_1j, s\}$  where  $l \cap l_1 = \{q, q_1j\}$ . Continuing this procedure one observes that it picks alternating lines from the two families given in Theorem 2.3.18 and the result is obtained.

■

Observe that  $\{l, l_1, l_2, l_3\}$  spans a 3-dimensional linear projective space  $L$ , which contains the real points of the initial circle. Since  $L$  is 3-dimensional  $L \cap Kl$  is a two-dimensional complex sub-quadric of  $Kl$ . But its real part contains a circle, thus its whole real part is a 2-sphere.

**Theorem 2.4.11** *Let  $\{l, l_1, l_2, l_3\}$  be a set of cyclically incident contact lines along a circle in  $S^4$ , then there is associated to this set a unique sphere containing that circle.*

**Proof.** Given  $\dim(\text{span}_{\mathbb{C}}\{l, l_1, l_2, l_3\}) = 4$ . Let  $C$  be the complex projective plane of the circle then  $C \subset L$  so that  $L^\perp \cap Kl = L^\perp \cap C^\perp = \{S, Sj\}$ . ■

That the real part of the three dimensional quadric is a 2-sphere may be seen in a simple example:

Consider  $\mathbb{C} \subset \mathbb{H} \subset \mathbb{HP}^1$  given by

$$\begin{bmatrix} \mathbb{C} \\ 1 \end{bmatrix}$$

so that  $\infty = \begin{bmatrix} 1 \\ 0 \end{bmatrix}$ . Let  $S = \mathbb{C} \cup \infty$ . Associating  $\mathbb{H}^2 \rightarrow \mathbb{C}^4$ ,

$$\begin{pmatrix} z \\ 1 \end{pmatrix} \mapsto \begin{pmatrix} z & 0 & 1 & 0 \end{pmatrix}^T = ze_1 + e_3$$

so that  $\mathbb{C}$  is represented by  $[e_1 \wedge e_3] \in Kl$ . Similarly  $\mathbb{C}j \mapsto [e_2 \wedge e_4]$ . Now, with reference to (2.15)

$$e_1 \wedge e_3^\perp = \text{span}_{\mathbb{C}}\{e_1 \wedge e_2, e_1 \wedge e_3, e_1 \wedge e_4, e_2 \wedge e_3, e_3 \wedge e_4\}$$

and

$$e_2 \wedge e_4^\perp = \text{span}_{\mathbb{C}}\{e_1 \wedge e_2, e_1 \wedge e_4, e_2 \wedge e_3, e_2 \wedge e_4, e_3 \wedge e_4\}$$

so that

$$\text{span}_{\mathbb{C}}\{e_1 \wedge e_3, e_2 \wedge e_4\}^\perp = \text{span}\{e_1 \wedge e_2, e_1 \wedge e_4, e_2 \wedge e_3, e_3 \wedge e_4\}.$$

Rewriting with respect to the basis (2.16),  $\{\omega_1, \omega_2, \omega_3, \omega_4, \omega_5, \omega_6\}$

$$\text{span}_{\mathbb{C}}\{e_1 \wedge e_3, e_2 \wedge e_4\}^\perp = \text{span}\{\omega_1, \omega_2, \omega_3, \omega_4\}.$$

One obtains that restriction of  $\langle, \rangle_K$  to this subspace of  $\mathbb{C}^6$  is given by

$$\begin{bmatrix} 1 & 0 & 0 & 0 \\ 0 & -1 & 0 & 0 \\ 0 & 0 & -1 & 0 \\ 0 & 0 & 0 & -1 \end{bmatrix} \quad (2.45)$$

Considering only real points, this is exactly the light-cone model of the 2-sphere.

Now, this may be turned around if you consider  $L = \text{span}_{\mathbb{C}}\{S, Sj\}^\perp$ . Thus, every point in  $Q_S = \mathbb{P}(L) \cap Kl$  corresponds to a line in  $\mathbb{CP}^3$  incident to both  $S$  and  $Sj$ . The real points of  $Q_S$  correspond to the points of  $S$ . Then,  $\sigma = \{q, rj\}$  defines a line that is incident

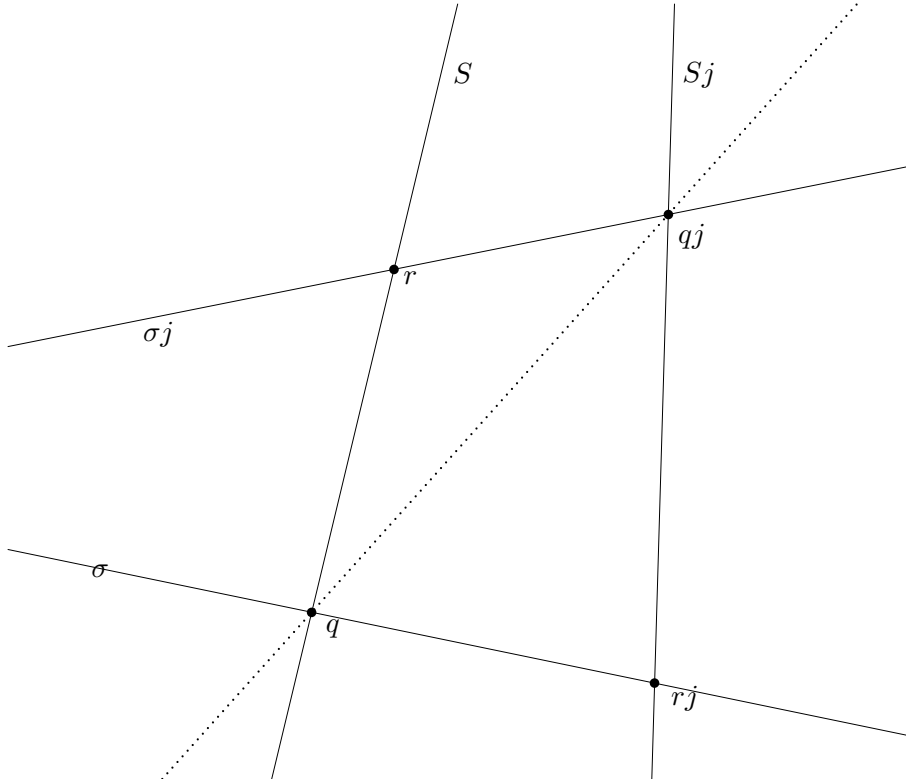

**Figure 13.** Intersection of four 2-spheres at two points,  $r$  and  $q$ .

to  $S$  at  $q$  and to  $S_j$  at  $r \neq q_j$ . This line corresponds, by definition, to a sphere which half-touches  $S$  at the points  $q$  and  $r$ . Hence,  $Q_S$ , as the set of spheres which touch both  $S$  and  $S_j$ , is the set of spheres which half-touch  $S$  and the points of  $S$  itself. Note that not every two-sphere which half-touches  $S$  also half-touches  $S_j$  as the set of two-spheres half-touching a given two-sphere is  $\mathbb{P}(S^\perp) \cap Kl$  minus those two-spheres which are in contact with  $S$ , which is a set of measure zero.

**Theorem 2.4.12** *Let  $S \in Kl$  correspond to a two-sphere in  $S^4$ . Let  $L = \text{span}_{\mathbb{C}}\{S, S_j\}^\perp < \mathbb{C}^6$  and  $Q_S = \mathbb{P}(L) \cap Kl$ . Then, the points of  $Q_S$  correspond to either points in  $S$  or two-spheres which half-touch  $S$  and  $S_j$ .*

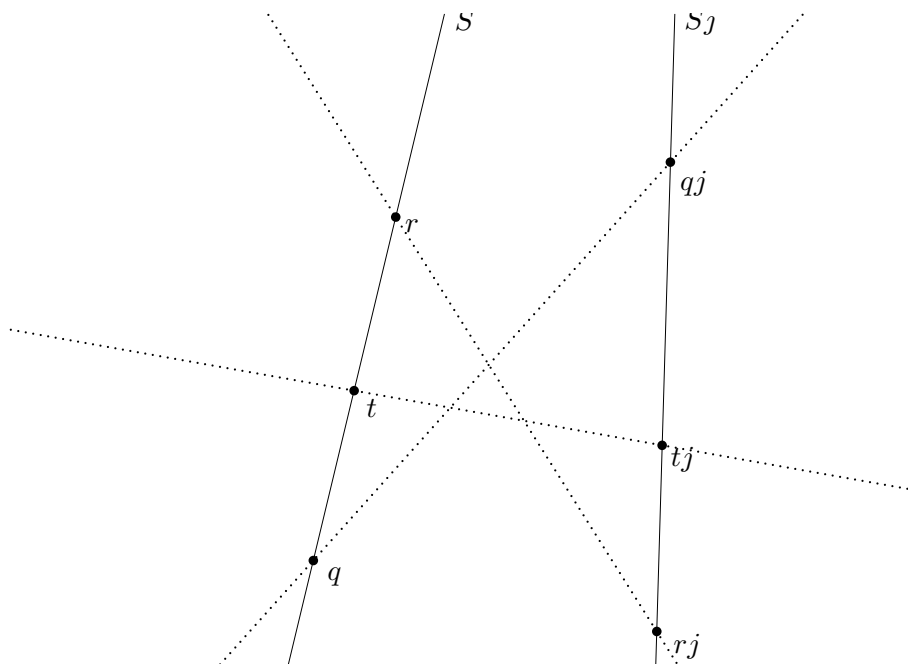

Figure 14. Three points on  $S$ .

## 2.5 $S^3$ Considered as a Subset of $S^4$

### 2.5.1 Quaternionic Hermitian forms

As motivation for defining the hyperspheres in  $S^4 \cong \mathbb{H}\mathbb{P}^1$  it is useful to consider hyperspheres in  $S^2 \cong \mathbb{C}\mathbb{P}^1$  i.e. circles. Let

$$\begin{bmatrix} 0 & 1 \\ 1 & 0 \end{bmatrix}$$

define a hermitian form on  $\mathbb{C}^2 = v\mathbb{C} \oplus w\mathbb{C}$ . Now, choose affine coordinates for  $\mathbb{C}\mathbb{P}^1$  of the form  $v\mathbb{C} + w$  where  $v$  is now the ‘point at infinity.’ The null set of this hermitian form is now given as solutions of the equation

$$\begin{bmatrix} \bar{z} & 1 \end{bmatrix} \begin{bmatrix} 0 & 1 \\ 1 & 0 \end{bmatrix} \begin{bmatrix} z \\ 1 \end{bmatrix} = \bar{z} + z = 0, \quad (2.46)$$

and  $\begin{bmatrix} 1 \\ 0 \end{bmatrix}$ , the point at infinity. This is the imaginary axis plus one point, a ‘circle through infinity.’ A change of affine chart moving infinity away from  $v$  will by Möbius

transformation reveal the 'round' circle.

Now, this construction may be repeated for  $\mathbb{HP}^1$ . Let  $\{v, w\}$  be a basis for  $V$  so that  $V = v\mathbb{H} \oplus w\mathbb{H} \cong \mathbb{H}^2$ . With respect to this basis, consider the quaternionic hermitian form on  $\mathbb{H}^2$  defined by

$$(x, y) = \begin{pmatrix} \bar{x}_0 & \bar{x}_1 \end{pmatrix} \begin{pmatrix} 0 & 1 \\ 1 & 0 \end{pmatrix} \begin{pmatrix} y_0 \\ y_1 \end{pmatrix} = \bar{x}_0 y_1 + \bar{x}_1 y_0. \quad (2.47)$$

Since this form takes values in  $\mathbb{H}$  one must pay careful attention to the order of multiplication of elements.

**Definition:** A quaternionic hermitian form on a  $\mathbb{H}$ -vector space  $V$  is a real bilinear form  $(, ) : V \times V \rightarrow \mathbb{H}$  with the properties:

1.  $(x\lambda, y\mu) = \bar{\lambda}(x, y)\mu$  for  $\lambda, \mu \in \mathbb{H}$
2.  $(y, x) = \overline{(x, y)}$

Let  $(x, x) = 0$  then  $(x\lambda, x\lambda) = \bar{\lambda}(x, x)\lambda = 0$ . So, the zero set of a quaternionic hermitian form respects the projection from  $\mathbb{H}^2 \rightarrow \mathbb{HP}^1$ . Consider the affine chart defined by  $w = 1$ , then the zero set is given by the equation for the affine parameter  $z = x_0/x_1 \in \mathbb{H} \cong \mathbb{R}^4$

$$\bar{z} + z = 0.$$

Thus the zero set consists of  $z \in Im(\mathbb{H}) \cong \mathbb{R}^3$  and the point at infinity  $v = \begin{bmatrix} 1 \\ 0 \end{bmatrix}$ . This set has the topology of a three dimensional sphere.

The quaternionic hermitian form takes values in  $\mathbb{H} = \mathbb{C} \oplus j\mathbb{C}$ . Write  $(x, y) = h(x, y) + j\omega(x, y)$ . Then,

$$\begin{aligned} (y, x) &= \overline{(x, y)} = \overline{h(x, y) + j\omega(x, y)} \\ &= \overline{h(x, y)} - j\overline{\omega(x, y)} \\ &= \overline{h(x, y)} - j\omega(x, y) \\ &= h(y, x) + j\omega(y, x). \end{aligned}$$

Hence,

$$\begin{aligned} h(y, x) &= \overline{h(x, y)} \\ \omega(y, x) &= -\omega(x, y). \end{aligned} \tag{2.48}$$

So, considering  $\mathbb{H}^2 \cong \mathbb{C}^4$ ,  $h(x, y)$  is a hermitian form on  $\mathbb{C}^4$  and  $\omega(x, y)$  is a complex alternating two-form.

**Lemma 2.5.1** *Let  $(, ) = h(, ) + j\omega(, )$  be a quaternionic hermitian form on  $\mathbb{H}^2 \cong \mathbb{C}^4$ , then*

1.  $h$  is a complex hermitian form on  $\mathbb{C}^4$ .
2.  $\omega \in \bigwedge^2 \mathbb{C}^{4*}$
3.  $h(x, xj) = 0$ , and  $h(x, x) = \overline{\omega(x, xj)}$
4.  $\omega(x, y) = -\overline{h(x, yj)}$ , and  $\omega(x, yj) = \overline{h(x, y)}$

The quaternionic hermitian form was defined with respect to the basis  $\{v, w\}$  so that  $(v, v) = (w, w) = 0$  and  $(v, w) = 1$ . Now, compute for  $a = a_0 + ja_1$ ,  $b = b_0jb_1$ ,

$$(va + wb, va + wb) = \bar{a}_0b_0 + \bar{a}_1b_1 + \bar{b}_0a_0 + \bar{b}_1a_1.$$

Hence, the matrix of  $h$  is given by

$$\begin{bmatrix} 0 & 0 & 1 & 0 \\ 0 & 0 & 0 & 1 \\ 1 & 0 & 0 & 0 \\ 0 & 1 & 0 & 0 \end{bmatrix}$$

and  $h$  has signature  $(2, 2)$ .

**Theorem 2.5.2** *The choice of  $S^3 \subset S^4$ , given as the zero set in  $\mathbb{HP}^1$  of a quaternionic hermitian form, induces a signature  $(2, 2)$  complex hermitian form on  $\mathbb{C}^4 \cong \mathbb{H}^2$ .*

A non-degenerate complex hermitian form  $h$  on  $V$  induces an injective anti-linear map  $V \rightarrow V^*$  by  $x \mapsto h(x, -) = h^*(x)$ . Thus,

$$h(x, y) = h^*(x)y.$$

Then,  $h^*$  induces an injective anti-linear map from  $\bigwedge^2 V \rightarrow \bigwedge^2 V^*$  by  $x \wedge y \mapsto h^*(x) \wedge h^*(y)$ . Thus,  $h$  induces a complex hermitian form on  $\bigwedge^2 V$  by

$$\begin{aligned} (a \wedge b, x \wedge y) &= h^*(a) \wedge h^*(b)(x \wedge y) \\ &= \det \begin{pmatrix} h^*(a)x & h^*(a)y \\ h^*(b)x & h^*(b)y \end{pmatrix} = h(a, x)h(b, y) - h(a, y)h(b, x). \end{aligned} \quad (2.49)$$

Each point  $u$  on a given line  $l$  in  $\mathbb{C}\mathbb{P}^3$  projects by the twistor map through a line  $u \wedge u_j$  to the point  $u\mathbb{H}$  in  $\mathbb{H}\mathbb{P}^1$ . Hence,  $h(u, u) = 0$  for all  $u \in l$  implies that  $l$  is contained in the  $S^3$  defined by the quaternionic hermitian form. Now,  $h(u, u) = 0$  implies  $(u \wedge u_j, u \wedge u_j) = 0$ . What is also true is that if  $l$  is contained within  $S^3$  then  $(l, l) = 0$ .

**Lemma 2.5.3**  *$(x \wedge y, x \wedge y) = 0$  if and only if the line represented by  $x \wedge y$  corresponds to a two-sphere (or point) contained within  $S^3$ .*

Thus, one sees that the intersection of the zero set of the induced hermitian form on  $\bigwedge^2 V$  with  $Kl$  determines all of the two dimensional spheres in the given  $S^3$  including all of the points, or zero radius spheres. Classically, this set is known as the *Lie quadric* of  $S^3$ . It will be shown that it is in fact a four-dimensional real quadric surface.

The basis  $\{v, vj, w, wj\}$  now induces a basis for  $\bigwedge^2 V$ . Recall that

$$\begin{aligned} h(v, v) &= 0 = h(w, w) \\ h(v, w) &= 1 = h(w, v) \\ h(v, wj) &= 0 = h(vj, w) \\ h(vj, wj) &= 1 = h(wj, vj). \end{aligned} \quad (2.50)$$

So, with respect to the basis,

$$\{v \wedge vj, w \wedge wj, v \wedge wj, vj \wedge w, v \wedge w, vj \wedge wj\}, \quad (2.51)$$



the induced hermitian form on  $\bigwedge^2 V$  is given by

$$\begin{bmatrix} 0 & 1 & 0 & 0 & 0 & 0 \\ 1 & 0 & 0 & 0 & 0 & 0 \\ 0 & 0 & 0 & -1 & 0 & 0 \\ 0 & 0 & -1 & 0 & 0 & 0 \\ 0 & 0 & 0 & 0 & -1 & 0 \\ 0 & 0 & 0 & 0 & 0 & -1 \end{bmatrix} \quad (2.52)$$

and is seen to have signature  $(2, 4)$ . With respect to the orthogonal basis:

$$\left\{ \frac{1}{2}(v \wedge vj + w \wedge wj), \frac{1}{2}(v \wedge wj - vj \wedge w), \frac{1}{2}(v \wedge vj - w \wedge wj), \frac{1}{2}(v \wedge wj + vj \wedge w), v \wedge w, vj \wedge wj \right\}, \quad (2.53)$$

the hermitian form is given by

$$\begin{bmatrix} 1 & 0 & 0 & 0 & 0 & 0 \\ 0 & 1 & 0 & 0 & 0 & 0 \\ 0 & 0 & -1 & 0 & 0 & 0 \\ 0 & 0 & 0 & -1 & 0 & 0 \\ 0 & 0 & 0 & 0 & -1 & 0 \\ 0 & 0 & 0 & 0 & 0 & -1 \end{bmatrix} \quad (2.54)$$

Let  $Li$  be the image of the zero set of the induced hermitian form inside  $Kl$ .  $Li$  is a real quadric inside  $\mathbb{P}(\bigwedge^2 V)$  whose signature agrees with the classic construction of the Lie quadric.  $Li$  has been given as a 'real slice' of the  $Kl$  corresponding to complex conjugation with respect to the orthonormal basis defined. This real structure is not uniquely defined since a unitary transform will preserve the orthonormal basis for  $h$  but deform the real set. However, there is a real structure induced directly on  $Kl$  by  $h$  whose real set agrees with the one just defined.

**Theorem 2.5.4** *The  $(2, 2)$  hermitian form  $h$  on  $V \cong \mathbb{C}^4$  induces a real structure on  $Kl$ . The real set associated to the real structure is given by a real nondegenerate quadric with signature  $(2, 4)$ .*

**Proof.** The nondegenerate hermitian form  $h$  induces a map  $V \rightarrow V^*$  by  $x \mapsto h(x, -)$ . Since this is antilinear and injective, a line  $l \in \mathbb{P}(V)$  is sent to a line  $l^b \in \mathbb{P}(V^*)$ . Duality on  $\mathbb{P}(V^*)$  maps a line  $k^* \subset \mathbb{P}(V^*)$  to a line  $l \subset \mathbb{P}(V)$  by

$$k^* \mapsto k^{**} = l = \mathbb{P}(\{[x] \in \mathbb{P}(V) : \alpha(x) = 0 : \alpha \in k^*\}). \quad (2.55)$$

The composition of these two maps is anti-holomorphic and is an involution. Note that this is simply taking each line to its hermitian normal space, which is also a line. Now, it must be shown that the real set of this real structure is the same as that given before. Let  $l$  be a line in  $\mathbb{P}(V)$  and  $x \in l$ . Then  $l^{b*} = l$  if and only if  $l^b = l^*$ . Then  $h(x, -) \in l^*$  if and only if  $h(x, y) = 0$  for all  $y \in l$ . But this is true if and only if  $h|_l = 0$ . ■

Since the points of  $S^3$  are also contained in the zero set,  $S^3$  should embed into  $Li$  as the projective image of a  $(1, 4)$  light-cone. However, looking at the orthogonal basis, there are, a priori, two possible axes to choose for the light cone giving  $S^3$ . This choice is made by the alternating form  $\omega$ , induced on  $\mathbb{C}^4$  by the quaternionic hermitian form. The alternating complex form  $\omega$  on  $V$  is an element of  $(\bigwedge^2 V)^*$ . Consider the orthogonal space (polar) of  $\omega$  in  $\bigwedge^2 V$  :

$$\omega^o = \text{Span}\{x \wedge y : \omega(x \wedge y) = \omega(x, y) = 0\}$$

Since  $\omega$  is paired to  $h$  by  $j$ , it suffices to examine the orthogonal basis for  $(,)$ . Hence,

$$\begin{aligned} \omega^o &= \text{Span} \left( \frac{1}{2}(v \wedge vj + w \wedge wj), \quad \frac{1}{2}(v \wedge vj - w \wedge wj), \quad \frac{1}{2}(v \wedge wj + vj \wedge w), \quad v \wedge w, \quad vj \wedge wj \right) \\ &= (v \wedge wj - vj \wedge w)^\perp. \end{aligned}$$

**Lemma 2.5.5** *Let  $x\mathbb{H} \in S^3 \subset \mathbb{H}\mathbb{P}^1$ , then  $x \wedge xj \in \omega^o \cap Li \cap Kl$ .*

**Proof.** Let  $x\mathbb{H} \in S^3$ , then  $h(x, x) = 0$ . So,  $\omega(x \wedge xj) = \omega(x, xj) = \overline{h(x, x)} = 0$ . ■

So, take the real span of the orthogonal basis for  $\omega^o \cong \mathbb{C}^5$ , then the intersection with  $Li \subset \mathbb{R}\mathbb{P}^5$  is given by the projective image of the  $(1, 4)$  light-cone which is the image of all the points in  $S^3 \subset \mathbb{H}\mathbb{P}^1$ . Equivalently,  $\langle, \rangle_K$  restricted to the real part of  $(v \wedge wj - vj \wedge w)^\perp$  is a real bilinear form with signature  $(1, 4)$ . Thus,

**Theorem 2.5.6** *The zero set of the quaternionic hermitian form defines a round three dimensional sphere in  $S^4$ .*

### 2.5.2 The line-sphere correspondence of Lie

Now, one may explicitly parameterize the *Lie* quadric starting from the familiar equation for a sphere contained in  $\mathbb{R}^3$  of radius  $r$  and center  $c$ :

$$(u - c) \cdot (u - c) = r^2. \quad (2.56)$$

From this starting point, invert stereographic projection  $S^3 \subset \mathbb{R}^4 \rightarrow \mathbb{R}^3$  by

$$u \mapsto \begin{pmatrix} \frac{1-u \cdot u}{1+u \cdot u} \\ \frac{2u}{1+u \cdot u} \end{pmatrix} \quad (2.57)$$

avoiding the point  $(-1, 0, 0, 0)$ . Now, consider  $\mathbb{R}^4$  as an affine chart on  $\mathbb{P}((v \wedge w j + v j \wedge w)^\perp)$ .

One then obtains homogeneous coordinates on this  $\mathbb{R}\mathbb{P}^4$  for the image of the inverse-projection

$$\begin{bmatrix} \frac{1}{2}(1 + u \cdot u) \\ \frac{1}{2}(1 - u \cdot u) \\ u \end{bmatrix} \quad (2.58)$$

where, from the perspective of  $\mathbb{R}^3 \subset S^3 \subset \mathbb{R}\mathbb{P}^4$ ,  $[1, -1, 0, 0, 0]$  is seen as the “point at infinity.” In  $\mathbb{R}^6$ ,

$$u \mapsto \begin{pmatrix} 0 \\ 1 \\ \frac{1-u \cdot u}{1+u \cdot u} \\ \frac{2u}{1+u \cdot u} \end{pmatrix}$$

with  $\infty = [0, 1, -1, 0, 0, 0] \in \mathbb{R}\mathbb{P}^5$ .

Rewriting (2.56) one obtains the equation for an affine quadric

$$u \cdot u - 2u \cdot c + c \cdot c - r^2 = 0. \quad (2.59)$$

i.e. the round two dimensional sphere in  $\mathbb{R}^3$  may be seen as the intersection of  $S^3$  with an affine hyper-plane in  $\mathbb{RP}^4$  or equivalently, a four dimensional subspace of  $\mathbb{R}^5$  with signature  $(1, 3)$  with respect to the restriction of the ambient bilinear form. Now, four dimensional non-degenerate subspaces may be identified with their normal spaces. Hence, one may identify two dimensional spheres with one dimensional subspaces of  $\mathbb{R}^5$  whose signature is negative (note that it is negative because the ambient form is of signature  $(1, 4)$  instead of  $(4, 1)$ .) One can determine the normal representative by a straightforward, if annoying, computation.

**Lemma 2.5.7** *A round two dimensional sphere with center  $c$  and radius  $r$  inside  $\mathbb{R}^3 \subset S^3 = \mathbb{R}^3 \cup \{\infty\} \subset \mathbb{R}^4$  where  $\infty = [1, -1, 0, 0, 0]$  defines a point in  $\mathbb{RP}^4$  given in homogeneous coordinates by*

$$[\xi] = \begin{bmatrix} \frac{1}{2}(1 + c \cdot c - r^2) \\ \frac{1}{2}(1 - c \cdot c + r^2) \\ c \end{bmatrix}, \quad (2.60)$$

where  $\langle \xi, \xi \rangle = -r^2$ .

The identification given by (2.60) between round spheres and projective hyperplanes intersecting  $S^3 \subset \mathbb{RP}^4$  is defined with respect a choice of a point at  $\infty$  on  $S^3$  and excludes those hyperplanes going through  $\infty$ . Thus, one has to distinguish between spheres containing  $\infty$  and those which don't. The idea is that spheres containing  $\infty$  will be observed as affine planes in  $\mathbb{R}^3$  :

$$u \cdot N = h \quad (2.61)$$

where one can take  $|N| = 1$ . A short computation obtains:

**Lemma 2.5.8** *An affine plane with normal  $N$  and inhomogenous term  $h$  inside  $\mathbb{R}^3 \subset S^3 \subset \mathbb{R}^4$  where  $\infty = [1, -1, 0, 0, 0]$  defines a point in  $\mathbb{RP}^4$  given in homogeneous coordi-*

notes by

$$[\xi] = \begin{bmatrix} h \\ -h \\ N \end{bmatrix} \quad (2.62)$$

Consider  $[\xi] \in \mathbb{RP}^4$  such that  $\langle \xi, \xi \rangle < 0$ . With the latter condition  $\xi^\perp$  has signature  $(1, 3)$ . Let  $\xi = (x_0, x_1, x) \in \mathbb{R}^5$ . Then,

$$\langle \xi, \infty \rangle = x_0 + x_1.$$

So, either  $\langle \xi, \infty \rangle = 0$  or  $\langle \xi, \infty \rangle \neq 0$ . Suppose that  $\langle \xi, \infty \rangle \neq 0$  then let

$$[\tilde{\xi}] = \left[ \frac{\xi}{x_0 + x_1} \right],$$

so that  $\tilde{x}_0 + \tilde{x}_1 = 1$ . Then writing  $c = \tilde{x}$  and  $-r^2 = \langle \tilde{x}, \tilde{x} \rangle$ , one obtains the form of (2.60).

If  $\langle \xi, \infty \rangle = 0$ , then  $\langle x, x \rangle = x_0^2 - x_1^2 - |x|^2 = -|x|^2$ , so that writing  $\tilde{\xi} = \frac{-\xi}{|x|}$  one obtains a vector of the form of (2.62).

**Theorem 2.5.9** *Let*

$$\xi \in \text{Span} \left\{ \left( \frac{1}{2}(v \wedge vj + w \wedge wj), \frac{1}{2}(v \wedge vj - w \wedge wj), \frac{1}{2}(v \wedge wj + vj \wedge w), v \wedge w, vj \wedge wj \right) \right\}$$

*such that  $\langle \xi, \xi \rangle < 0$ , then  $[\xi]$  corresponds to a two dimensional sphere in  $S^3 \subset \mathbb{P}(\mathbb{R}^5)$  defined by  $S^3 \cap \mathbb{P}(\xi^\perp)$ .*

Let  $[\xi]$  such that  $\langle \xi, \xi \rangle = -\rho^2$ , then  $\tilde{\xi} = \frac{1}{\rho}\xi$  so that  $\langle \tilde{\xi}, \tilde{\xi} \rangle = -1$ . Thus, every such  $[\xi]$  may be chosen so that  $\xi$  is an element of the affine quadric in  $\mathbb{R}^5$  defined by

$$1 + \langle \xi, \xi \rangle = 0.$$

Let  $\zeta = \begin{pmatrix} 1 \\ \xi \end{pmatrix} \in \text{Span} \left\{ \frac{1}{2}(v \wedge vj + w \wedge wj), \frac{1}{2}(v \wedge wj - vj \wedge w), \frac{1}{2}(v \wedge vj - w \wedge wj), \frac{1}{2}(v \wedge wj + vj \wedge w), v \wedge w, vj \wedge wj \right\}$  then one observes that

$$\langle \zeta, \zeta \rangle = 1 + \langle \xi, \xi \rangle = 0$$

so that  $[\zeta] \in Li \subset \mathbb{RP}^5$  as previously defined. Now, let  $[\zeta] = \begin{bmatrix} \rho \\ \xi \end{bmatrix} \in Li$ , then

$$\langle \zeta, \zeta \rangle = \rho^2 + \langle \xi, \xi \rangle = 0$$

so that  $\langle \xi, \xi \rangle = -\rho^2$ . Then, as before, one can determine the affine properties by testing whether  $\langle \xi, \infty \rangle = 0$ . However, given  $[\zeta] = \begin{bmatrix} -\rho \\ \xi \end{bmatrix}$  one obtains the same radius and center point. Thus, one sees that points in  $Li$  represent *oriented* two dimensional spheres in  $S^3$ .

**Theorem 2.5.10** *Choose  $\infty = [0, 1, -1, 0, 0, 0] \in S^3$ , then the following homogeneous coordinates parameterize points, two dimensional round spheres, and affine planes in  $S^3 \subset Li \subset Kl \subset \mathbb{CP}^5$ :*

*Given  $u \in \mathbb{R}^3$ , the corresponding point in  $S^3 \setminus \{\infty\} \subset Li$  is given by:*

$$\begin{bmatrix} 0 \\ \frac{1}{2}(1 + u \cdot u) \\ \frac{1}{2}(1 - u \cdot u) \\ u \end{bmatrix} \quad (2.63)$$

*Given a round sphere in  $\mathbb{R}^3$  with center  $c$  and radius  $r$  the corresponding point is given by:*

$$\begin{bmatrix} \pm r \\ \frac{1}{2}(1 + c \cdot c - r^2) \\ \frac{1}{2}(1 - c \cdot c + r^2) \\ c \end{bmatrix} \quad (2.64)$$

*Given an affine plane with unit normal  $N \in \mathbb{R}^3$  and inhomogenous term  $h$  the corresponding point is given by:*

$$\begin{bmatrix} \pm 1 \\ h \\ -h \\ N \end{bmatrix} \quad (2.65)$$

These computations give coordinates for points in  $Li$  with respect to the basis (2.53) for  $\wedge^2 \mathbb{C}^4$ . Since  $Li \subset Kl$ , points in  $Li$  correspond to projective lines in  $\mathbb{C}\mathbb{P}^3$ . Thus one may compute the *complex* line associated to a point in  $Li$  by inverting the Plücker map. For convenience this will be done with respect to the basis (2.14). So, given  $[y_1, y_2, y_3, y_4, y_5, y_6]$  in basis (2.53), the change of coordinates to (2.14) gives coordinates  $[x_1, x_2, x_3, x_4, x_5, x_6] = [\frac{1}{2}(y_1 + y_3), y_5, \frac{1}{2}(y_2 + y_4), \frac{1}{2}(y_4 - y_2), y_6, \frac{1}{2}(y_1 - y_3)]$ .

**Theorem 2.5.11** *Let  $[x] = [x_1, x_2, x_3, x_4, x_5, x_6] \in Li \subset Kl$  with respect to the the basis given in (2.14), then  $[x] = [k_1 \wedge k_2]$  where*

$$k_1 = x_2x_3v + (x_3x_4 + x_1x_6)vj + x_2x_6w \quad (2.66)$$

and

$$k_2 = x_1vj + x_2w + x_3wj. \quad (2.67)$$

**Proof.** Compute  $k_1$  and  $k_2$  by carefully following the proof of Theorem 2.2.6. ■

Note that this is not a parameterization of all of  $Li$ , only those spheres not incident to the chosen point at  $\infty \in S^3 \subset S^4$ . Further, since the coordinates of  $[x]$  are all real, one may consider  $k_1$  and  $k_2 \in \mathbb{R}^4 \equiv \text{Span}_{\mathbb{R}}\{v, vj, w, wj\}$  or in other words  $[k_1 \wedge k_2]$  is a line in  $\mathbb{R}\mathbb{P}^3$ . Hence,

**Corollary 2.5.12 (Line-Sphere Correspondence)** *Given a choice of  $\infty \in S^3$ , the set of two-spheres in  $Li$  not containing  $\infty$  is contained within the set of projective lines in  $\mathbb{R}\mathbb{P}^3$ .*

Note that this is not an identification between  $Li$  and the set of all real projective lines in  $\mathbb{R}\mathbb{P}^3$ , which is parameterized by the real (3, 3) Plücker quadric compared to the Lie quadric which has signature (2, 4). With respect to the chosen basis  $\{v, vj, w, wj\}$  on  $V$  one sees the Plücker quadric as the restriction of the Klein form on the real span of the induced basis in  $\wedge^2 V$  so that the "Line-Sphere Correspondence" is the parameterization of the intersection of the Plücker quadric and the Lie quadric, so defined inside the

Klein quadric. Choosing a new point at  $\infty$  for  $S^3$  will define a new basis for  $V$  in this construction and thus define a new Plücker quadric within  $Kl$ , changing the corresponding "line-sphere correspondence."

### 2.5.3 Circles in $S^3$

Considering  $S^3$  as a subset of  $S^4$ , one now applies the results for circles in  $\mathbb{H}\mathbb{P}^1$  to characterize circles within  $S^3$ .  $S^3$  is now given as the real set of a  $\mathbb{C}\mathbb{P}^4 < \mathbb{C}\mathbb{P}^5$  as in the previous section. A circle given in  $S^4$  defines a one-dimensional complex quadric in  $Kl$ . The result will be that there is a unique unoriented two-sphere contained in  $S^4$  associated to each circle in  $S^3$  with the interpretation that the circle is given as the intersection of that two-sphere with  $S^3$ . The space of circles in  $S^3$  will then be shown to be  $Q = Kl \cap \mathbb{C}\mathbb{P}^4$ .

**Theorem 2.5.13** *Let  $\alpha$  be a circle  $\alpha \subset S^3 \subset \mathbb{C}\mathbb{P}^4$ , then there is a unique pair  $\{[z], [zj] \in Q \setminus S^3\}$  with the property that the two-sphere associated to  $\{[z], [zj]\}$  contains  $\alpha$ . The set of circles in  $S^3$ , including points, is thus parametrized by a three-dimensional complex quadric  $Q = Kl \cap \mathbb{C}\mathbb{P}^4$ .*

#### Proof.

Choose three points  $\{L, M, N\}$  on  $\alpha$ . Let  $V < \wedge^2 \mathbb{C}^4$  be the span of  $\{L, M, N\}$ . Then  $P(V)$  defines a  $\mathbb{C}\mathbb{P}^2 < \mathbb{C}\mathbb{P}^4$ . The one-dimensional quadric  $\subset P(V^\perp)$  defined in Theorem 2.3.25 cannot be contained in this  $\mathbb{C}\mathbb{P}^4$  as  $\mathbb{C}^6 = V \oplus V^\perp$ . The intersection  $V^\perp \cap \mathbb{C}\mathbb{P}^4$  is a projective line so that  $V^\perp \cap \mathbb{C}\mathbb{P}^4 \cap Kl$  consists of two points. Let  $[z]$  be one point. Then  $[zj] \in \mathbb{C}\mathbb{P}^4$  as  $\omega(zj) = \bar{\omega}(z) = 0$

Now, choose  $[z] \in \mathbb{C}\mathbb{P}^4$  not contained in  $S^3$ . Then  $[zj]$  is similarly in  $\mathbb{C}\mathbb{P}^4$ . Let  $V$  be the span of  $\{z, zj\} < \mathbb{C}^5$ . As the lines corresponding to  $\{[z], [zj]\}$  are disjoint by construction,  $\{[z], [zj]\}$  cannot lie on a projective line contained within  $Kl$ . Hence  $\{[z], [zj]\} = \mathbb{P}(V) \cap Kl$ . Now, consider  $V^\perp < \mathbb{C}^5$ . Claim: the real part of  $\mathbb{P}(V^\perp) \cap Kl$  is a circle in  $S^3$ . ■

Now consider the following classical result:



**Lemma 2.5.14 (Touching Coins Theorem)** *Whenever four circles in three-space touch cyclically but do not lie in a common sphere, they intersect the sphere which passes through the four points of contact orthogonally.*

As the four circles do not lie on a common sphere, their representatives in  $Q$  span a three-dimensional linear projective space. Hence there is a unique two-sphere in  $S^4$  in contact with all four representatives. With the generic assumption that the four points of contact do not lie on a circle; one sees that they span the same three-dimensional space. Hence the unique two-sphere defined by those four points is also the unique two-sphere in contact with all four representatives. Thus, the two-sphere defined by the four contact points must half-touch each representative as the intersection with each contains exactly two points.

## CHAPTER 3

### DISCRETE DIFFERENTIAL GEOMETRY

#### 3.1 Philosophy

A smooth surface in space may be parameterized and from that parameterization its intrinsic and extrinsic properties determined by calculation. It is the hypothesis of "discrete differential geometry" that the essential local properties of smooth surfaces may be encompassed within parameterizations constructed with locally finite data. This discrete data may be first classified by combinatorics. I will only consider the combinatorics of the square grid  $\mathbb{Z}^2$  and avoid global questions. A discrete parameterization will attach objects to this lattice. Those objects may be points in space, but they may also be planes or spheres or objects of higher dimension. All models will be constructed within some projective space. But, one must consider whether the properties to be investigated are projectively invariant, or whether they involve a choice of affine structure or geometry given by some quadratic form.

#### 3.2 A little naive quaternionic surface theory.

Let  $\Sigma$  be a 2-dimensional real smooth manifold i.e. a surface and let

$$\phi : \Sigma \rightarrow \mathbb{H}\mathbb{P}^1$$

be a smooth immersion. Assume that the image of  $\phi$  lies in an affine chart of  $\mathbb{H}\mathbb{P}^1$  centered at  $\phi(p)$  so that locally on  $\Sigma$  and writing  $\phi = \begin{bmatrix} f \\ 1 \end{bmatrix}$  one may consider

$$f : U \subset \Sigma \rightarrow \mathbb{H}$$

where  $f(p) = 0$ . Exploiting this naive viewpoint one then may write

$$d_p f(T_p \Sigma) = W < \mathbb{H},$$

where  $W \cong \mathbb{R}^2 < \mathbb{H} \cong \mathbb{R}^4$ .

**Lemma 3.2.1** *Let  $a \in \mathbb{H}$ , then  $a^2 = -1$  if and only if  $|a| = 1$  and  $a \in Im\mathbb{H}$*

**Lemma 3.2.2** *Let  $W < \mathbb{H}$  with  $W \cong \mathbb{R}^2$ , then there exist unique (up to sign)  $N, R \in Im\mathbb{H}$  such that  $N^2 = R^2 = -1$  and  $z \in W$  iff*

$$\begin{aligned} NW = W = WR \\ NzR = z. \end{aligned} \tag{3.1}$$

**Proof.**

Suppose that  $1 \in W$ . Now, choose  $a \in W \cap Im\mathbb{H}$  such that  $|a| = 1$ . Then, by the previous lemma,  $a^2 = -1$ . Let  $x = x_1 + x_2 a \in W$ , then  $ax(-a) = x$ . Thus,  $N = a$ , and  $R = -a$ . Then, if  $\tilde{N}W = W$ ,  $\tilde{N} = \tilde{N}1 \in W$  and  $a \in W$  so  $\tilde{N} = a$  or  $\tilde{N} = -a$ . Now, suppose  $1 \notin W$ . Choose  $z \in W$  and  $z \neq 0$ . Then,  $1 \in z^{-1}W$  so that  $N = zaz^{-1}$  and  $R = -a$ . ■

Consider, as an example,  $W = span_{\mathbb{R}}\{j, k\} < Im\mathbb{H}$ . Let  $v = xj + yk \in W$ . Then,

$$ivi = (xj(-i) + yk(-i))i = v$$

so that  $N = R = i = jk = j \times k$ , considering  $j, k \in Im\mathbb{H} \cong \mathbb{R}^3$ . Thus,  $N$  is identified with the unit normal with positive orientation to the  $\{j, k\}$  plane. However, it is clear that  $(-i)v(-i) = v$  as well. Thus, the choice of sign for  $N$  (and by extension  $R$ ) corresponds to a choice of orientation of  $W$ .

Now, write

$$S = \begin{bmatrix} N & 0 \\ 0 & -R \end{bmatrix}. \quad (3.2)$$

By construction,  $S^2 = -1$  so that, looking back to Theorem 2.3.5,  $S$  characterizes a two-sphere in  $\mathbb{H}\mathbb{P}^1$  by  $v \in \mathbb{H}^2$  such that

$$Sv = vi. \quad (3.3)$$

Let  $v = \begin{pmatrix} x \\ y \end{pmatrix}$ , then  $Sv = vi$  implies

$$\begin{aligned} Nx &= xi \\ -Ry &= yi. \end{aligned} \quad (3.4)$$

Writing  $[v] = \begin{bmatrix} xy^{-1} \\ 1 \end{bmatrix}$  calculate:

$$Nxy^{-1} = xiy^{-1} = xy^{-1}(-R)$$

so that  $Nxy^{-1}R = xy^{-1}$ . Now consider  $Sj = \{vj : Sv = vi\}$ . It is clear that, for  $vj \in Sj$ ,  $-Nvj = vji$  and  $Rvj = vji$ . Thus one sees that  $j$  acts on  $S$  by reversing the orientation.

Hence, up to orientation,  $d_p f(T_p \Sigma)$  is identified with the two-sphere  $S$  and by construction  $S$  is tangent to  $f(\Sigma)$  at  $p$ . However, this identification is with respect to the choice of affine chart on  $\mathbb{H}\mathbb{P}^1$ . Changing the point at  $\infty$  in  $\mathbb{H}\mathbb{P}^1$  will send  $S$  in the new chart to a round sphere, whereas  $d_p f$  computed in this chart will still be a real 2-dimensional plane.

So, with respect to the original affine chart Corollary 2.3.11 gives the set of two-spheres tangent to  $S$  at  $f(p)$  in the form

$$S_H = \begin{bmatrix} N & 0 \\ *H & -R \end{bmatrix}. \quad (3.5)$$

and by Theorem 2.3.15 this is a one-parameter complex family. The tangent map of an immersion of a surface at each point determines the data  $(N_p, R_p)$  at each  $p \in \Sigma$  which

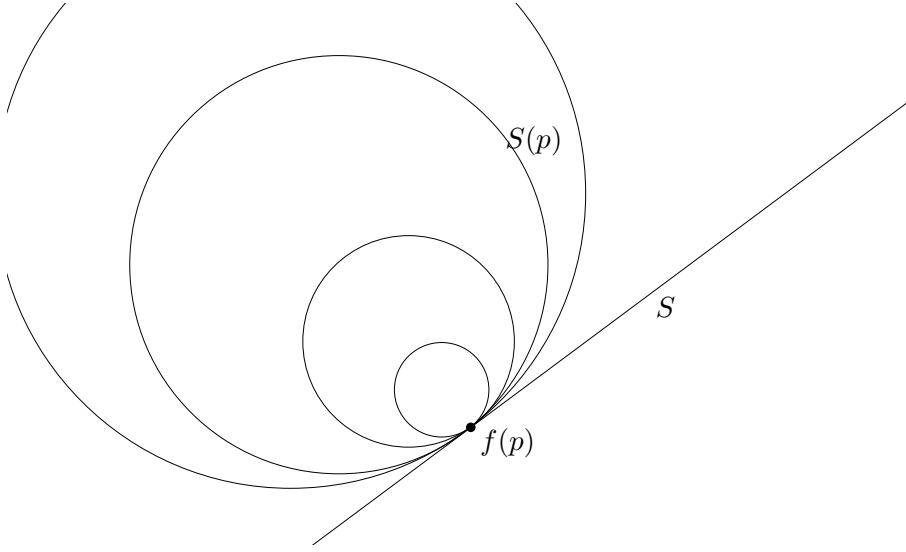

**Figure 15.** A complex pencil of spheres tangent at  $f(p)$ .

in turn defines a contact line in  $Kl$  associated to that point. Thus, associated to an immersion of the surface in  $\mathbb{H}\mathbb{P}^1$  is a map into the space of contact lines in  $Kl$ .

Now, suppose that  $\Sigma$  is a Riemann surface and hence there is a complex structure  $J_p : T_p\Sigma \rightarrow T_p\Sigma$ . Observe that for  $W_p = d_p f(T_p\Sigma)$ ,  $N_p : W_p \rightarrow W_p$  acts as an orthogonal transformation with respect to the Euclidean metric on  $\mathbb{H}$ .

**Definition:** Let  $\Sigma$  be a Riemann surface with complex structure  $J : T\Sigma \rightarrow T\Sigma$ . Then, a smooth immersion  $f : \Sigma \rightarrow \mathbb{H}$  is conformal if

$$*df = df \circ J = Ndf. \quad (3.6)$$

Given an immersion  $f$  on the Riemann surface  $\Sigma$ , one may define a sphere congruence  $S(p)$  for  $p \in \Sigma$  by choosing at  $f(p)$  a sphere tangent to  $f(\Sigma)$  at  $p$ , that is an element of the contact line at  $f(p)$ . Thus, considering the identification of  $\mathbb{H}\mathbb{P}^1$  with  $S^4 \subset Kl$  given by Theorem 2.2.26, a sphere congruence is a map  $S : \Sigma \rightarrow Kl$ . In addition, given the complex structure on  $\Sigma$  there is a unique sphere congruence defined along the contact lines of the tangent map called the “mean sphere congruence.[14]”

One may show [13] that the mean curvature sphere congruence is defined by choosing the sphere tangent to  $f(\Sigma)$  with mean curvature equal to  $f(\Sigma)$ . It is surprising that this

mean curvature sphere is in fact a conformal invariant and this may be seen by showing that it is given by the four-dimensional distribution in  $\mathbb{C}^6$  defined by

$$V(p) = \text{span}_{\mathbb{C}}\{\phi(p), d_p\phi, \phi_{z\bar{z}}\},$$

where  $\phi$  is considered to be a lift of the associated map into  $S^4 \subset Kl \subset \mathbb{C}\mathbb{P}^5$ . The mean sphere congruence is shown to be given by  $V(p)^\perp \cap Kl = \{S_p, S_p j\}$ , choosing an appropriate orientation.

Thus, the addition of conformality to a given immersion  $f$  on a Riemann surface defines a unique sphere in each contact line associated to the immersion. Hence, there is a canonical framing of the contact line associated to  $f$  given by  $\{f(p), S(p)\}$ .

### 3.3 Planar nets

**Definition:** ( $\mathbb{Z}^2$  NET) A two dimensional net is a map  $\phi : \mathbb{Z}^2 \rightarrow \mathbb{C}\mathbb{P}^n$  such that  $\phi$  takes different values on adjacent lattice points. The edges of the net are defined by unordered pairs of points:

$$\{(i, j), (i + 1, j)\} \tag{3.7}$$

or  $\{(i, j), (i, j + 1)\}$ . The faces of the net correspond to quadruples of points

$$\{(i, j), (i + 1, j), (i + 1, j + 1), (i, j + 1)\}. \tag{3.8}$$

A net has only combinatorial structure. Each vertex has four edges incident to it and thus is adjacent to four neighboring vertices. Each face of a net has four vertices and four edges incident to it. As each face contains four vertices, the maximum projective dimension associated of the span of the vertices of each face is then three. Requiring that the vertices of each face lie in a projective plane induces a linear constraint on the vertices of each face i.e.

$$\phi_{i+1j+i} = \phi_{ij}a + \phi_{i+1j}b + \phi_{ij+1}c.$$

where  $\phi$  is some lift of the net into homogenous coordinates.

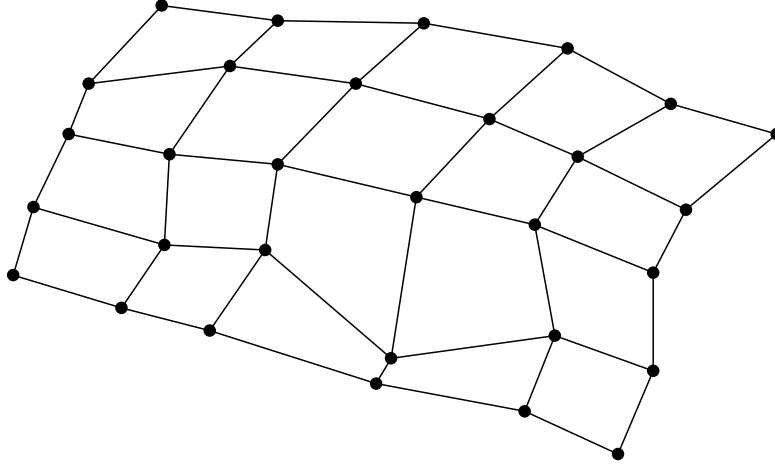

**Figure 16.** A planar quadrilateral net

**Definition:** (PLANAR NET) A planar net is a net where the four vertices incident to each face are contained in a projective plane.

This may be written in terms of the 'translation' operator  $\tau$  where  $\tau_1\phi(m, n) = \phi(m + 1, n)$  and  $\tau_2(m, n) = \phi(m, n + 1)$  as

$$\tau_i\tau_j\phi = \phi a + \tau_i\phi b + \tau_j\phi c.$$

Consider one face of the net:

$$\{\phi, \phi_1, \phi_2, \phi_{12}\}.$$

Define the difference operator  $\Delta_i = \tau_i - 1$ . Then, one calculates that

$$\Delta_{12}\phi = \Delta_1\Delta_2\phi = \Delta_1\phi_2 - \Delta_1\phi = \phi_{12} - \phi_1 - \phi_2 + \phi = \Delta_2\phi_1 - \Delta_2\phi. \quad (3.9)$$

**Lemma 3.3.1** Let  $\phi : \mathbb{Z}^2 \rightarrow \mathbb{C}^{n+1}$  be a two-dimensional net, then

$$\Delta_1\Delta_2\phi = \Delta_2\Delta_1\phi$$

**Lemma 3.3.2** Suppose  $M, N : \mathbb{Z}^2 \rightarrow \mathbb{C}^{n+1}$ , then  $\Delta_1\phi = M$  and  $\Delta_2\phi = N$  define a net  $\phi : \mathbb{Z}^2 \rightarrow V$  if and only if  $\Delta_1N = \Delta_2M$ .

Now, using (3.9)

$$\phi_{12} - \phi = \Delta_{12}\phi + \phi_1 + \phi_2 - 2\phi = \Delta_{12}\phi + \Delta_1\phi + \Delta_2\phi.$$

Assume that  $\{\phi, \phi_1, \phi_2, \phi_{12}\}$  are contained within an affine chart. Given these affine coordinates, the planarity condition may be expressed by

$$\phi_{12} = a\Delta_1\phi + b\Delta_2\phi + \phi. \quad (3.10)$$

Then,

$$\Delta_{12}\phi = (a-1)\Delta_1\phi + (b-1)\Delta_2\phi.$$

One may now reverse this computation. Within this affine chart if

$$\Delta_1\Delta_2\phi = A\Delta_1\phi + B\Delta_2\phi \quad (3.11)$$

then  $\{\phi, \phi_1, \phi_2, \phi_{12}\}$  is planar.

**Theorem 3.3.3** *Let  $\phi : \mathbb{Z}^2 \rightarrow \mathbb{C}^{n+1}$  define a two-dimensional net in an affine chart of  $\mathbb{CP}^n$ , then there exist  $c_{21}, c_{12} : \mathbb{Z}^2 \rightarrow \mathbb{C}$ , such that*

$$\Delta_1\Delta_2\phi = c_{21}\Delta_1\phi + c_{12}\Delta_2\phi \quad (3.12)$$

Given two functions  $c_{12}, c_{21} : \mathbb{Z}^2 \rightarrow \mathbb{C}$ , it is possible to specify a planar quadrilateral lattice using (3.12) provided sufficient boundary conditions: values of  $\phi$  on the two lattice coordinate axes  $(\mathbb{Z}, 0)$  and  $(0, \mathbb{Z})$ . Note that no conditions are imposed upon the choice of lattice functions.

Given a planar quadrilateral lattice, it is possible to extend it to a three-dimensional lattice with the property that each face of the lattice in all directions is planar i.e.  $\Phi : \mathbb{Z}^3 \rightarrow V$  such that  $\Phi(m, n, 0) = \phi(m, n)$ . The crucial observation is that this is possible for each hexahedron of  $\mathbb{Z}^3$ .

**Theorem 3.3.4** *Suppose planar nets are defined on the three coordinate planes of  $\mathbb{Z}^3$ . Then there is a unique planar net extending onto all of  $\mathbb{Z}^3$ .*



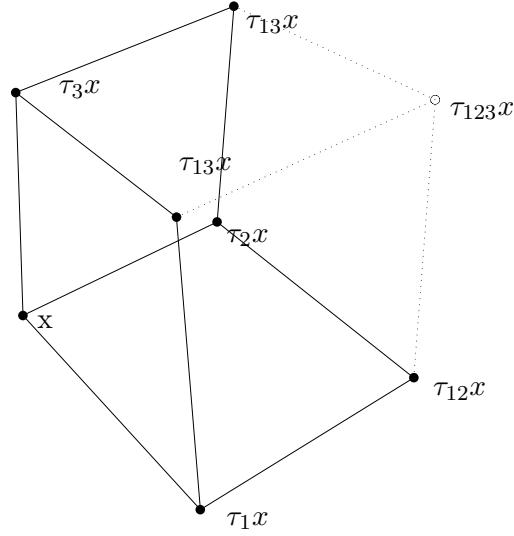

**Figure 17. The elementary hexahedron.**

It suffices to prove that, for a single “box” of  $\mathbb{Z}^3$  incident to  $(0, 0, 0)$  and positive, that if planar faces are defined for the three faces incident to  $(0, 0, 0)$  then the net on this initial box is uniquely determined.

**Theorem 3.3.5 (Hexahedron Lemma)** *Consider the elementary hexahedron of  $\mathbb{Z}^3$  incident to  $(0, 0, 0)$  and  $(1, 1, 1)$ . If a planar map is defined on the vertices of the three faces of this hexahedron incident to  $(0, 0, 0)$  then there is a unique extension to the point  $(1, 1, 1)$  so that all faces of the elementary hexahedron incident to it are planar.*

**Proof.**

Defining the net on the initial faces of the hexahedron, one may then extend the map by the same procedure in all directions. Given  $\phi$  on the seven points of the hexahedron containing the origin and lying on the coordinate planes, write  $\phi(0, 0, 0) = \phi$ . Then,  $\tau_i \phi$

represents the value of  $\phi$  in the  $i^{th}$  coordinate direction. The seven points are then

$$\{\phi, \tau_1\phi, \tau_2\phi, \tau_3\phi, \tau_2\tau_1\phi, \tau_3\tau_2\phi, \tau_1\tau_3\phi\}.$$

Now  $\{\phi, \tau_1\phi, \tau_2\phi, \tau_3\phi\}$  spans a three dimensional projective space  $\Sigma$ . Since  $\phi$  on the coordinate planes is a planar net,  $\{\phi, \tau_1\phi, \tau_2\phi\}$  define a projective plane  $\Pi_{12} \subset \Sigma$  containing  $\tau_2\tau_1\phi$  and likewise for  $\Pi_{13}$  and  $\Pi_{23}$ , the two other sides of the box. Then  $\{\tau_1\phi, \tau_2\tau_1\phi, \tau_1\tau_3\phi\}$  defines a projective plane  $\tau_1\Pi_{23}$  as does  $\tau_2\Pi_{13}$  and  $\tau_3\Pi_{12}$  all of which are contained in  $\Sigma$ . Assume that three planes are not all incident to one line, then three planes in a three dimensional projective space must meet in a point. ■

As each face of the lattice maps to a plane the value of the map at each vertex of each face satisfies eq.3.12. Each elementary hexahedron of  $\mathbb{Z}^3$  maps to a three dimensional projective space. By computation each  $\Delta_i(\Delta_j\Delta_k\phi)$  for  $1 \leq i, j, k \leq 3$  lies in the span of  $\{\Delta_1\phi, \Delta_2\phi, \Delta_3\phi\}$ . Equating coefficients one obtains:

$$\Delta_i c_{jk} = (\tau_k c_{ij})c_{jk} + (\tau_k c_{ji})c_{ik} - (\tau_i c_{jk})c_{ik}, i \neq j \neq k \neq i. \quad (3.13)$$

So, extending the lattice from  $\mathbb{Z}^2$  to  $\mathbb{Z}^3$  adds an additional constraint. Another way of seeing this constraint is to consider the boundary value problem for the three dimensional  $PQ$ -net: specifying the map on the boundary planes  $\{(\mathbb{Z}, 0, 0), (0, \mathbb{Z}, 0), (0, 0, \mathbb{Z})\}$  exactly defines the lattice. The Hexahedron Lemma insures that this initial data is consistent.

Examining the Hexahedron lemma, it is an almost entirely a combinatorial result: the dimension of the spanning space of the elementary hexadron compared to the number of faces incident to a vertex. It is now possible to extend it to the four-dimensional “box.”

**Theorem 3.3.6 (4-dimensional “Hexahedron” Lemma)** *Consider  $\Xi$ , the elementary “box” of  $\mathbb{Z}^4$  incident to  $(0, 0, 0, 0)$ , as the extension of the initial elementary hexahedron of  $\mathbb{Z}^3$ . Suppose a planar map is defined on all vertices excepting  $\tau_{1234}x$ , then there is a unique extension to  $\tau_{1234}x$  so that each face incident to this point is planar.*

**Proof.** It suffices to consider the case of projective spaces of dimension four or greater, as the 3-dimensional case reverts to previous Hexahedron Lemma. Now, suppose a planar

net  $x$  is defined on all vertices except  $(1, 1, 1, 1)$ . Assume that the points  $\{x, \tau_1 x, \tau_2 x, \tau_3 x, \tau_4 x\}$  are in general position and thus span a 4-dimensional linear projective space. There are 4 three-dimensional lattice hexahedrons incident to  $(1, 1, 1, 1)$ . The image of each hexahedron under  $x$  spans a three-dimensional space. Thus,  $\tau_{1234}x$  must lie in the intersection of 4 three-dimensional linear projective subspaces of a four-dimensional projective space. Generically such an intersection consists of one point. ■

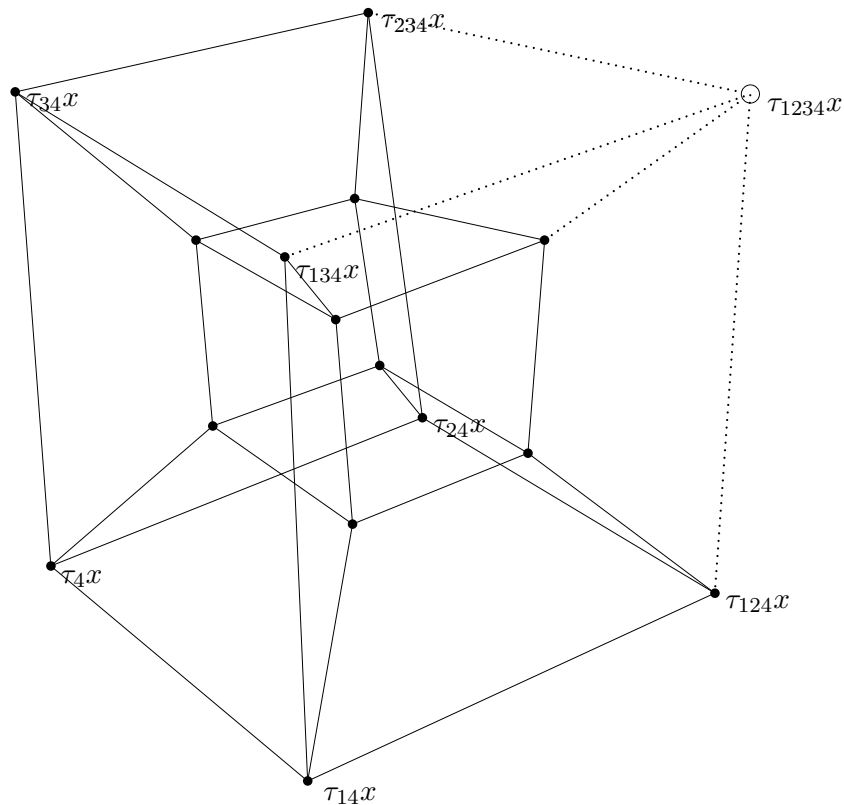

**Figure 18. The elementary 4-dimensional “cube.”**

Another way of viewing the previous theorem is as a permutability relationship between discrete planar surfaces. The classical example of such a relationship for smooth surfaces is Bianchi permutability between “soliton surfaces.” Consider the  $\mathbb{Z}^3$  lattice as a

$\mathbb{Z}$ -sequence of  $\mathbb{Z}^2$  discrete surfaces. Each level is connected to the previous and succeeding level-surfaces by planar quadrilaterals.

**Definition:** (FUNDAMENTAL TRANSFORMATION) Let  $\phi$  and  $\psi$  be two planar nets. If  $\{\phi, \tau_i\phi, \psi, \tau_i\psi\}$  is planar for all  $\phi, \psi$  and  $i \in \{1, 2\}$  then  $\phi$  and  $\psi$  will be said to be related by a “fundamental transformation.”

**Theorem 3.3.7 (Fundamental Permutability Theorem)** *Let  $\phi$  be a planar net. Suppose that there exist planar nets  $\xi$  and  $\eta$  which are each fundamental transformations of  $\phi$ . Then, there is a two-parameter family of planar nets  $\psi$  with the property that  $\psi$  is a fundamental transformation of  $\xi$  and  $\eta$ .*

**Proof.**

One may arrange the nets  $\phi, \xi, \eta$  so that an elementary face of  $\phi$  is related to an elementary face of  $\xi$  and  $\eta$  along independent directions in the four-dimensional lattice with  $\tau_1\phi = \eta$  and  $\tau_2\phi = \xi$ . Now, consider the plane spanned by the points  $\phi, \xi, \eta$ . Hence, there is a two-parameter choice of points in this plane which will be labeled  $\psi$ . By the hexahedron lemma there is now a unique point  $\psi_{123}$  so that  $\{\phi_3, \xi_3, \eta_3, \psi_{123}\}$  is planar. Now, by the hexahedron lemma again there is a unique point  $\psi_{124}$  such that  $\{\phi_4, \xi_4, \eta_4, \psi_{124}\}$  is planar. The proof then follows that of the four-dimensional hexahedron lemma defining a final point  $\psi_{1234}$  and determining an elementary face of the planar net  $\psi$ . ■

**Theorem 3.3.8 ( $n$ -dimensional “Hexahedron” Lemma)** *Consider the elementary “box” of  $\mathbb{Z}^n$  incident to  $(0, 0, 0, \dots, 0)$ , as the extension of the initial elementary hexahedron of  $\mathbb{Z}^{n-1}$ . Suppose a planar map is defined on all vertices excepting  $\tau_{1234\dots n}x$ , then there is a unique extension to  $\tau_{1234\dots n}x$  so that each face incident to this point is planar.*

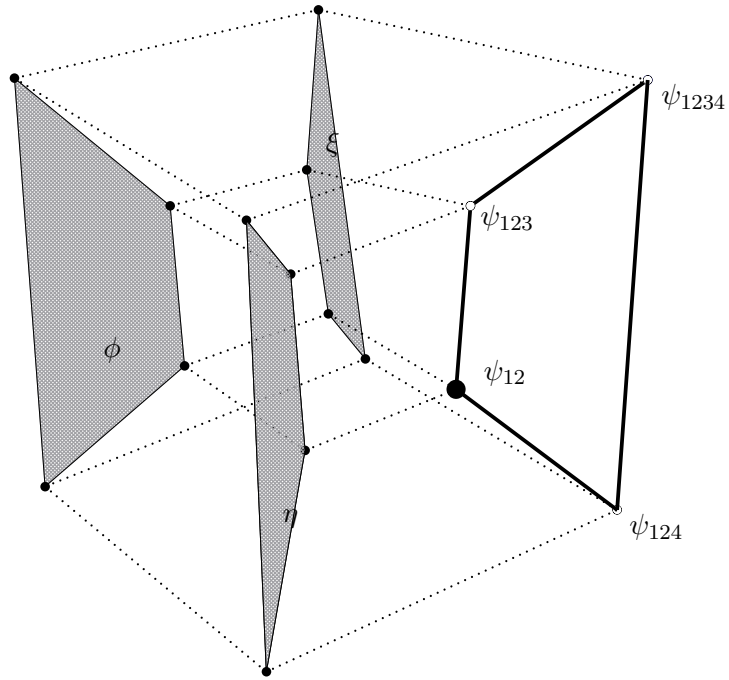

Figure 19. Discrete Bianchi permutability.

### 3.4 Discrete nets in quadrics

There are two fundamental discretization principles which define "discrete differential geometry"

- I. If a smooth parametrization has a family of discrete transformations associated to it, then the surface may be discretized by extending the lattice of discrete transformations homogeneously in the two directions transverse to the direction of the transformation.
- II. A discrete two-dimensional net is a solution of a "discrete integrable system" if the conditions defining that net may be extended from  $\mathbb{Z}^2$  to  $\mathbb{Z}^3$  and then to  $\mathbb{Z}^n$  such that the condition is applied isotropically with respect to the lattice directions. Levels in the lattice correspond to a discrete family of transformations of a given level and the consistency of the extended net defines permutation relations among these transformations.

The result of this becomes that the Hexahedron Lemma defines discrete integrability as a consistency condition on extending a system to a higher dimension lattice. However, the applicability of the theory relies on the relevance of planar nets through their application to the projective model of geometry. Thus, it remains to be shown that the discretization principles are satisfied when the vertices are constrained to lie on quadric hypersurfaces of some projective space.

Consider a quadric hypersurface  $Q \subset \mathbb{C}\mathbb{P}^n$   $Q = \{[x] \in \mathbb{C}\mathbb{P}^n : \langle x, x \rangle = 0\}$  defined by some bilinear form  $\langle, \rangle$ . Let  $\phi : \mathbb{Z}^2 \rightarrow Q$  be a planar net with this quadratic constraint:

$$\langle \phi, \phi \rangle = 0.$$

One then hopes that the Hexahedron lemma holds with respect to this constraint and this turns out to be true. The Hexahedron lemma for  $\mathbb{C}\mathbb{P}^n$  was obtained by considering the intersection of three planes in

$$\Sigma = \text{span}_{\mathbb{C}}\{\phi, \tau_1\phi, \tau_2\phi, \tau_3\phi\}$$

where  $\mathbb{P}(\Sigma) \cong \mathbb{C}\mathbb{P}^3$ . Let  $\Pi_{jk}$  be the projective plane spanned by  $\{\phi, \tau_j\phi, \tau_k\phi\}$ , then the faces of the elementary hexahedron are given as the union of three pairs of planes of the form  $\Pi_{jk} \cup \tau_i\Pi_{jk}$ . Then,  $\Pi_{jk} \cup \tau_i\Pi_{jk}$  as the union of two planes is a degenerate quadric in  $\mathbb{C}\mathbb{P}^3$  e.g.  $xz = 0$ . Thus, one should now consider the intersection of three degenerate quadrics and  $Q$ .

**Lemma 3.4.1** *The set of quadric surfaces in  $\mathbb{C}\mathbb{P}^n$  is parametrized by  $\mathbb{P}(W)$  where  $\dim(W) = \frac{1}{2}(n+2)(n+1)$ .*

**Proof.** Given a basis, a bilinear form on  $\mathbb{C}^{n+1}$  is represented by a symmetric  $(n+1) \times (n+1)$  matrix. Symmetric matrices form a vector space  $W = \text{Sym}(n+1, \mathbb{C})$  with dimension  $\frac{1}{2}(n+2)(n+1)$ . If  $q \in W$  then  $q(x, x) = 0$  implies  $q'(x, x) = 0$  for all  $q' \in \mathbb{C}q$ . Thus, the set of quadric surfaces is parametrized by  $\mathbb{P}(\text{Sym}(n+1, \mathbb{C}))$  ■

**Lemma 3.4.2** *The set of quadric surfaces incident to  $m$  distinct points in  $\mathbb{C}\mathbb{P}^n$  is a projective space of dimension  $\frac{1}{2}(n+3)n - m$ .*

**Proof.**

Let  $[x] \in \mathbb{CP}^n$ , then  $q \mapsto q(x, x)$  is a linear function on  $W = \text{Sym}(n+1, \mathbb{C})$ . So,  $H_x = \{q : q(x, x) = 0\}$  is a projective hyperplane in  $\mathbb{P}(W)$ . ■

**Theorem 3.4.3 (Quadric Hexahedron lemma)** *Suppose planar nets are defined on the three coordinate planes of  $\mathbb{Z}^3$  such that each vertex lies in a quadric surface  $Q \subset \mathbb{CP}^n$ . Then the unique planar extension to a  $\mathbb{Z}^3$  net also lies within  $Q$ .*

**Proof.**

By the previous lemmas the space of quadrics incident to the seven given vertices is a two dimensional projective plane. By construction, the three degenerate quadrics

$$u\{q_1 = \tau_1\Pi_{23} \cup \Pi_{23}, q_2 = \tau_2\Pi_{13} \cup \Pi_{13}, q_3 = \tau_3\Pi_{12} \cup \Pi_{12}\}$$

are incident to each of the seven points in  $Q$  and are linearly independent in  $\text{Sym}(n+1, \mathbb{C})$ . As before, the generic intersection of the three final planes of the hexahedron in  $\mathbb{CP}^3$  consists of a single point  $[p]$ . Thus,  $[p]$  is the eighth point of intersection, lying in each degenerate quadric. By construction, each of the initial seven points lies in  $Q$ , thus  $Q \in \text{span}_{\mathbb{C}}\{q_1, q_2, q_3\}$ , i.e.  $Q = \lambda q_1 + \mu q_2 + \nu q_3$ . But then  $Q(p) = 0$  and  $[p] \in Q$ . ■

The proof of the consistency of an extension to the four-dimensional lattice is almost automatic.

**Theorem 3.4.4 (4-dimensional Quadric “Hexahedron” Lemma)** *Consider  $\Xi$ , the elementary “box” of  $\mathbb{Z}^4$  incident to  $(0, 0, 0, 0)$ , as the extension of the initial elementary hexahedron of  $\mathbb{Z}^3$ . Suppose a planar map is defined on all vertices excepting  $\tau_{1234}x$  so that each vertex lies in the quadric  $Q$ , then there is a unique extension to  $\tau_{1234}x \in Q$  so that each face incident to this point is planar.*

**Proof.** From the four-dimensional Hexahedron Lemma  $t_{1234}x$  lies in the four-dimensional space spanned by  $\{x_0, x_1, x_2, x_3, x_4\}$ . Then,  $t_{1234}x$  is incident to four 3–dimensional hexahedrons contained in this space. Choosing one, the Quadric Hexahedron Lemma gives

$\tau_{1234}x$  is the “eighth” point of an elementary quadric of that hexahedron and hence contained in quadric defined by  $\text{span}_{\mathbb{C}}\{x_0, x_1, x_2, x_3, x_4\}$ . ■

Given this, the fundamental permutability relationship between planar nets still holds when those nets are restricted to a quadric surface. However, the fundamental transformation for quadric nets will require a further condition: the irreducibility of the quadric defined by the intersection of each planar face with the underlying quadric.

**Definition:** (RIBAUCOUR TRANSFORMATION) Let  $\phi$  and  $\psi$  be two quadric planar nets constructed so that each face of the hexahedron associated to each pair of associated faces defines a irreducible one-dimensional subquadric, then  $\psi$  and  $\psi$  are said to be related by a “Ribaucour” transformation.

Consider eq. (3.12) for a planar net. Now, adding the constraint that each vertex lie in a given quadric and that the intersection of the plane of each face is an irreducible sub-quadric can be seen as a reduction of the planar system. This follows from eq. (2.44)

$$\begin{aligned} x_{12} &= x_0 + \frac{t_1}{1+t_1+t_2} \Delta_1 x + \frac{t_2}{1+t_1+t_2} \Delta_2 x \\ t_1 &= \frac{a_{02}}{a_{12}} (1-\lambda) \\ t_2 &= \frac{a_{01}}{a_{12}} \frac{1-\lambda}{\lambda}. \end{aligned}$$

which determines the point  $x_{12}$  from  $\{x_0, x_1, x_2\}$  and the Steiner cross-ratio  $\lambda$ . Then, from eq. (3.10) one sees that the coefficients of eq. (3.12) are determined entirely by defining a cross ratio for each  $x_0$  of the net (corresponding to each face.) Thus, the data needed to specify a  $\mathbb{Z}^2$  net is reduced from two functions on the lattice to just one: the cross-ratio.

**Theorem 3.4.5** *Let initial data be given on  $\{(m, 0)\} \cup \{(0, n)\} \subset \mathbb{Z}^2$  into a projective quadric and  $\lambda : \mathbb{Z}^2 \rightarrow \mathbb{C}$ . Then, a planar quadric net  $\phi : \mathbb{Z}^2 \rightarrow Q$  is defined by interpreting  $\lambda(m, n)$  as the Steiner cross-ratio  $[\phi(m+1, n), \phi(m, n), \phi(m, n+1), \phi(m+1, n+1)]$  of the elementary face at  $\phi(m, n)$ .*



As before, given the cross-ratio as a lattice function on  $\mathbb{Z}^2$ , the initial value problem for a quadric planar net on  $\mathbb{Z}^2$  is solvable for initial values given along the coordinate axes. Now, given the quadric Hexahedron Lemma, the quadric planar system on  $\mathbb{Z}^2$  may be extended to a consistent quadric planar  $\mathbb{Z}^3$ -net defined by cross-ratios on the three coordinate planes. I will now record the calculation of Doliwa [GIL] **Proof**.

In order to calculate an explicit formula for the  $\mathbb{Z}^3$ -lattice, it suffices to consider an initial hexahedron and determine the coordinates of the point  $x_{123}$ . With  $\{x_0, x_1, x_2\}$  in the initial  $\mathbb{Z}^2$  lattice add to this  $x_3$  in the new lattice direction. Thus  $\{x_0, x_1, x_2, x_3\}$  span a three dimensional linear projective space containing the image of the initial hexahedron, with initial faces spanned by  $\{x_0, x_1, x_2\}$ ,  $\{x_0, x_1, x_3\}$ , and  $\{x_0, x_2, x_3\}$ . Now, write

$$x_{12} = \begin{bmatrix} a_0 \\ a_1 \\ a_2 \\ 0 \end{bmatrix}, x_{13} = \begin{bmatrix} b_0 \\ b_1 \\ 0 \\ b_3 \end{bmatrix}, x_{23} = \begin{bmatrix} c_0 \\ 0 \\ c_2 \\ c_3 \end{bmatrix}.$$

Then, one obtains equations for the final planar faces spanned by  $\{x_1, x_{12}, x_{13}\}$ ,  $\{x_2, x_{12}, x_{23}\}$ , and  $\{x_3, x_{13}, x_{23}\}$  as

$$a_2 b_3 t_0 = a_0 b_3 t_2 + b_0 a_2 t_3,$$

$$a_1 c_3 t_0 = a_0 c_3 t_1 + c_0 a_1 t_3,$$

$$b_1 c_2 t_0 = b_0 c_2 t_1 + c_0 b_1 t_2,$$

where  $x \in \text{span}_{\mathbb{C}}\{x_0, x_1, x_2, x_3\}$  is written  $x = t_0 x_0 + t_1 x_1 + t_2 x_2 + t_3 x_3$ . Now,  $x_{123} = y_0 x_0 + y_1 x_1 + y_2 x_2 + y_3 x_3$  may be calculated as the intersection of the three final face planes:

$$\begin{aligned} y_0 &= a_0 b_0 c_0 \left( \frac{1}{a_2 b_1 c_3} + \frac{1}{a_1 b_3 c_2} \right), \\ y_1 &= \frac{b_0 c_0}{b_3 c_2} + \frac{a_0 c_0}{a_2 c_3} + \frac{c_0^2}{c_2 c_3}, \\ y_2 &= \frac{a_0 b_0}{a_1 b_3} + \frac{b_0 c_0}{b_1 c_3} + \frac{b_0^2}{b_1 b_3}, \\ y_3 &= \frac{a_0 c_0}{a_1 c_2} + \frac{a_0 b_0}{a_2 b_1} + \frac{a_0^2}{a_1 a_2}. \end{aligned} \tag{3.14}$$

As calculated, this is an explicit formula for a planar net. However, with the assumption that the intersection of each face plane with the underlying quadric is irreducible, one may now parameterize these coordinates in terms of the cross ratios of the initial three faces. As  $\{x_0, x_1, x_2, x_3\}$  are in the quadric and thus null, the equation for the subquadric defined by the intersection of  $\text{span}_{\mathbb{C}}\{x_0, x_1, x_2, x_3\}$  must be of the form

$$a_{01}t_0t_1 + a_{02}t_0t_2 + a_{03}t_0t_3 + a_{12}t_1t_2 + a_{13}t_1t_3 + a_{23}t_2t_3 = 0.$$

Choosing orientations, let

$$\begin{aligned}\lambda &= [x_1, x_0, x_2, x_{12}] \\ \nu &= [x_2, x_0, x_3, x_{23}] \\ \mu &= [x_1, x_0, x_3, x_{13}]\end{aligned}\tag{3.15}$$

Now, repeat the calculation for eq. (2.43)

$$\begin{aligned}x_{12} &= x_0 + t_1x_1 + t_2x_2, \\ t_1 &= \frac{a_{02}}{a_{12}}(\lambda - 1) \\ t_2 &= \frac{a_{01}}{a_{12}} \frac{1 - \lambda}{\lambda}.\end{aligned}$$

to derive equivalent expressions for  $x_{13}$  and  $x_{23}$  and write:

$$x_{12} = \begin{bmatrix} \frac{\lambda a_{12}}{1 - \lambda} \\ -\lambda a_{02} \\ a_{01} \\ 0 \end{bmatrix}, x_{23} = \begin{bmatrix} \frac{\nu a_{23}}{1 - \nu} \\ 0 \\ -\nu a_{03} \\ a_{02} \end{bmatrix}, x_{13} = \begin{bmatrix} \frac{\mu a_{13}}{1 - \mu} \\ -\mu a_{03} \\ 0 \\ a_{01} \end{bmatrix}.\tag{3.16}$$

Now, inserting these into eq. (2.41) one determines

$$\begin{aligned}x_{123} &= y_0x_0 + y_1x_1 + y_2x_2 + y_3x_3 : \\ y_0 &= \frac{a_{12}a_{23}a_{13}}{a_{01}a_{02}a_{03}} \frac{\lambda\nu - \mu}{(1 - \lambda)(1 - \mu)(1 - \nu)} \\ y_1 &= \frac{a_{23}}{1 - \nu} \left( \frac{a_{13}}{a_{01}a_{03}} \frac{\mu}{1 - \mu} - \frac{a_{23}}{a_{02}a_{03}} \frac{\nu}{1 - \nu} - \frac{a_{12}}{a_{01}a_{02}} \frac{\lambda\nu}{1 - \lambda} \right) \\ y_2 &= \frac{a_{13}}{1 - \mu} \left( -\frac{a_{13}}{a_{01}a_{03}} \frac{\mu}{1 - \mu} + \frac{a_{23}}{a_{02}a_{03}} \frac{\nu}{1 - \nu} + \frac{a_{12}}{a_{01}a_{02}} \frac{\mu}{1 - \lambda} \right) \\ y_3 &= \frac{a_{12}}{1 - \lambda} \left( \frac{a_{13}}{a_{01}a_{03}} \frac{\lambda}{1 - \mu} - \frac{a_{23}}{a_{02}a_{03}} \frac{1}{1 - \nu} - \frac{a_{12}}{a_{01}a_{02}} \frac{\lambda}{1 - \lambda} \right).\end{aligned}\tag{3.17}$$

Finally, from the coordinates of  $x_{123}$  one may calculate the cross-ratios on the final three faces of the hexahedron:

$$\begin{aligned} [x_{13}, x_3, x_{23}, x_{123}] &= -\frac{\mu(1-\nu)a_{13}y_1}{\nu(1-\mu)a_{23}y_2} \\ [x_{12}, x_2, x_{23}, x_{123}] &= -\lambda\frac{(1-\nu)a_{12}y_1}{(1-\lambda)a_{23}y_3} \\ [x_{12}, x_1, x_{13}, x_{123}] &= -\frac{(1-\mu)a_{12}y_2}{(1-\lambda)a_{13}y_3}. \end{aligned} \tag{3.18}$$

■

It is now possible to derive equations similar to eq. (3.13) describing quadric planar  $\mathbb{Z}^3$ -nets in terms of the cross-ratios of opposing faces of their elementary hexahedrons.

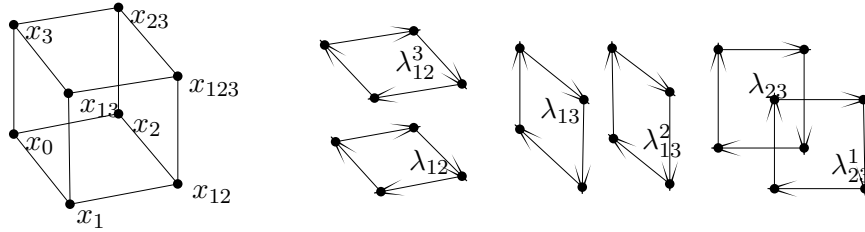

Figure 20. Cross-ratios and orientations.

**Theorem 3.4.6** *Let  $x : \mathbb{Z}^3 \rightarrow \mathbb{CP}^n$  be a quadric planar net such that each face defines an irreducible quadric and define a cross-ratio for each face by*

$$\lambda_{ij} = [\tau_i x, x, \tau_j x, \tau_i \tau_j x]. \tag{3.19}$$

*Then, this system of cross-ratios satisfies*

$$\lambda_{12}\tau_3(\lambda_{12})\lambda_{23}\tau_1(\lambda_{23}) = \lambda_{13}\tau_2(\lambda_{13}). \tag{3.20}$$

**Proof.**

It suffices to consider the initial hexahedron so that the cross-ratios of the initial faces are given by  $\lambda = \lambda_{12}, \mu = \lambda_{13}, \nu = \lambda_{23}$  as in eq. (3.15). Now, consider

$$\tau_3 \lambda = [x_{13}, x_3, x_{23}, x_{123}]$$

$$\tau_2 \mu = [x_{12}, x_2, x_{23}, x_{123}]$$

$$\tau_1 \nu = [x_{12}, x_1, x_{13}, x_{123}]$$

Now, using eq. (3.18) calculate that

$$\frac{\tau_3(\lambda)\tau_1(\nu)}{\tau_2(\mu)} = \frac{\mu}{\lambda\nu}.$$

Now, rearrange to obtain  $\lambda\tau_3(\lambda)\nu\tau_1(\nu) = \mu\tau_2(\mu)$ . ■

### 3.4.1 Real reduction of the planar quadric net

The quadric planar net is a reduction of the planar net, requiring only one function defined on  $\mathbb{Z}^2$  to specify a discrete surface from initial data. Each net is assumed to take coordinates in  $\mathbb{C}^{n+1} \rightarrow \mathbb{C}\mathbb{P}^n$ . Given a real structure on  $\mathbb{C}\mathbb{P}^n$  one can now reduce the planar system by requiring it to lie in the real set of that real structure. Further, given a quadric planar system, it should be possible, in some circumstances, by reduction to determine a *real* quadric planar system.

For my purposes, I will only consider the real structure on  $\mathbb{C}\mathbb{P}^n$  induced by a real structure  $\rho: \mathbb{C}^{n+1} \rightarrow \mathbb{C}^{n+1}$ . Further, if  $W < \mathbb{C}^{n+1}$  is the real set of  $\rho$ , I will require that  $\dim_{\mathbb{R}}(W) = n + 1$  so that  $W \cong \mathbb{R}^{n+1}$  and the induced real structure on  $\mathbb{C}\mathbb{P}^n$  has as real set  $\mathbb{P}(W) \cong \mathbb{R}\mathbb{P}^n$ .

**Theorem 3.4.7 (Real Hexahedron Lemma)** *Consider the elementary hexahedron of  $\mathbb{Z}^3$  incident to  $(0, 0, 0)$  and  $(1, 1, 1)$ . Let  $\rho$  be a real structure on  $\mathbb{C}^{n+1}$  with real set  $W \cong \mathbb{R}^{n+1}$ . If a planar map is defined on the vertices of the three faces of this hexahedron incident to  $(0, 0, 0)$  so that each vertex lies in  $\mathbb{P}(W)$ , then there is a unique extension to the point  $(1, 1, 1)$  so that the real span of the vertices of each face of the elementary hexahedron is planar and contained within  $\mathbb{P}(W) \cong \mathbb{R}^{n+1}$ .*

**Proof.**

This follows directly from (3.14): as all  $x_i$  are in  $W$ , all coefficients in eq's (3.14) are real and thus  $x_{123} \in W$ . ■

**Definition:** Let  $\{\rho, \mathbb{C}^{n+1}\}$  be a real structure, then a real symmetric bilinear form  $q$  on  $\{\rho, \mathbb{C}^{n+1}\}$  is a symmetric bilinear form of  $\mathbb{C}^{n+1}$  with the property that  $q(\rho(x)) = \bar{q}(x)$ .

Thus, a real symmetric bilinear form  $q$  on  $\{\rho, \mathbb{C}^{n+1}\}$  restricted to  $W$  determines a real bilinear form, that is,  $q : W \times W \rightarrow \mathbb{R}$ . This is equivalent to the existence of a basis  $\{v_1, \dots, v_{n+1}\}$  for  $W$  such that  $q(v_i) \in \mathbb{R}$  for  $i \in \{1, \dots, n+1\}$ .

**Lemma 3.4.8** *Let  $\{\rho, \mathbb{C}^{n+1}\}$  be a real structure with real set  $W \cong \mathbb{R}^{n+1}$  and  $q$  a complex bilinear form on  $\mathbb{C}^{n+1}$  with the property that  $q(x) = 0$  iff  $q(\rho(x)) = 0$ . Let  $Q \subset \mathbb{C}\mathbb{P}^n$  be the complex projective quadric variety defined by  $\{q = 0\}$ . Suppose  $q$  restricts to a real bilinear symmetric form on  $W$  then  $\rho$  defines a real structure on  $Q$  with real set given by  $\mathbb{P}(W) \cap Q$ .*

Given the conditions of the Hexahedron Lemma, as  $x_{123}$  must be in  $\mathbb{P}(W)$ , the quadric Hexahedron Lemma applies to quadrics contained in  $\mathbb{P}(W) \cong \mathbb{R}\mathbb{P}^n$ . However, real degeneracy also involves avoiding imaginary solutions to the quadratic form. Now, requiring each initial face of the elementary Hexahedron to be an irreducible real quadric, the cross ratio formula gives an explicit proof that the "eighth point" of the elementary hexahedron is not an imaginary solution. However, it will be required that the cross-ratio on the initial three faces must take values in  $\mathbb{R}$ . Following (3.16), the coefficients  $a_{ij}$  are real by the assumption that  $q$  restricted to the "real" basis  $\{x_0, \dots, x_3\}$  is a real quadratic form. Then, if  $\lambda, \mu, \nu \in \mathbb{R}$ , the coordinates of  $x_{ij}$  for  $i, j \in \{1, 2, 3\}$ , must also lie in  $\mathbb{R}$ , ensuring that the points given by the real cross-ratio formulas are contained in  $W$ . Finally, following (3.17),  $x_{123}$  as a function of  $\lambda, \mu, \nu$ , and all the  $a_{ij}$  must have real coefficients and  $x_{123} \in W$ .

Thus, it is obtained that one may reduce a complex planar net by the addition of a real structure. The two main examples of real structures given in this work serve as examples, namely those which define  $S^4 \subset Kl$  and  $Li \subset Kl$ . Each were defined by a real basis upon which  $\langle, \rangle_{Kl}$  restricts to a real quadratic form, which defines the real set as a real quadric contained in  $Kl$ .

### 3.4.2 Real quadric planar nets in $S^2$ : circles

Consider  $\mathbb{C} \subset \mathbb{H} \subset \mathbb{HP}^1$  given by

$$\begin{bmatrix} \mathbb{C} \\ 1 \end{bmatrix}$$

so that  $\infty = \begin{bmatrix} 1 \\ 0 \end{bmatrix}$ . Let  $S = \mathbb{C} \cup \{\infty\}$ . Identifying  $\mathbb{H}^2 \cong \mathbb{C}^4$ ,

$$\begin{pmatrix} z \\ 1 \end{pmatrix} \mapsto \begin{pmatrix} z & 0 & 1 & 0 \end{pmatrix}^T = ze_1 + e_3$$

so that  $S$  is represented by  $[e_1 \wedge e_3] \in Kl$ . Similarly  $\mathbb{C}j \mapsto [e_2 \wedge e_4]$ . Now, with reference to (2.15)

$$e_1 \wedge e_3^\perp = \text{span}_{\mathbb{C}}\{e_1 \wedge e_2, e_1 \wedge e_3, e_1 \wedge e_4, e_2 \wedge e_3, e_3 \wedge e_4\}$$

and

$$e_2 \wedge e_4^\perp = \text{span}_{\mathbb{C}}\{e_1 \wedge e_2, e_1 \wedge e_4, e_2 \wedge e_3, e_2 \wedge e_4, e_3 \wedge e_4\}$$

so that

$$\text{span}_{\mathbb{C}}\{e_1 \wedge e_3, e_2 \wedge e_4\}^\perp = \text{span}\{e_1 \wedge e_2, e_1 \wedge e_4, e_2 \wedge e_3, e_3 \wedge e_4\}.$$

Rewriting with respect to the basis (2.16),

$$\begin{aligned}
& \{e_1 \wedge e_2 + e_3 \wedge e_4, \\
& e_1 \wedge e_2 - e_3 \wedge e_4, \\
& e_2 \wedge e_3 - e_1 \wedge e_4, \\
& (e_2 \wedge e_3 + e_2 \wedge e_4)i, \\
& e_1 \wedge e_3 + e_2 \wedge e_4, \\
& (e_1 \wedge e_3 - e_2 \wedge e_4)i\} \\
& = \{\omega_1, \omega_2, \omega_3, \omega_4, \omega_5, \omega_6\},
\end{aligned} \tag{3.21}$$

$$span_{\mathbb{C}}\{e_1 \wedge e_3, e_2 \wedge e_4\}^{\perp} = span_{\mathbb{C}}\{\omega_1, \omega_2, \omega_3, \omega_4\} = W.$$

One obtains that the restriction of  $\langle, \rangle_K$  to this subspace of  $\mathbb{C}^6$  is given by

$$\begin{bmatrix} 1 & 0 & 0 & 0 \\ 0 & -1 & 0 & 0 \\ 0 & 0 & -1 & 0 \\ 0 & 0 & 0 & -1 \end{bmatrix} \tag{3.22}$$

Considering only real points, this is exactly the light-cone model of the 2-sphere. With  $S = [e_1 \wedge e_3] \in Kl$  and  $Sj = [e_2 \wedge e_4]$  one obtains the round two-sphere as a real quadric defined as the real set of the real structure “ $j$ ” on the complex quadric  $Q_S = \mathbb{P}(span_{\mathbb{C}}\{e_1 \wedge e_3, e_2 \wedge e_4\}^{\perp}) \cap Kl$ . where  $\{S, Sj\}^{\perp} = \mathbb{P}(W)$

Writing  $W = span_{\mathbb{C}}\{e_1 \wedge e_3, e_2 \wedge e_4\}^{\perp}$ , one may consider planar nets in  $\mathbb{P}(W) \cong \mathbb{C}\mathbb{P}^3$ . In general, a planar quadric net in  $Q_S \mathbb{P}(W)$  may fail to contain points of  $S$ . Recalling Theorem 2.4.12, the points of  $Q_S$  not in  $S$  correspond to two-spheres which half-touch both  $S$  and  $Sj$ . However, if you consider those planar nets whose vertices are contained in  $S$  then you obtain a real quadric planar net.

**Lemma 3.4.9** *Let  $\phi : \mathbb{Z}^2 \rightarrow \mathbb{P}(W)$  be a planar net with the property that  $\phi(m, n) \in S, \forall (m, n) \in \mathbb{Z}^2$ , then  $\phi$  defines a planar net in  $\mathbb{P}(Re(W)) \cong \mathbb{R}\mathbb{P}^3$*

**Proof.**

Let  $f, f_1, f_2, f_{12} \in W$  correspond to the points of an elementary face of  $\phi$ . As  $\{f, f_1, f_2, f_{12}\}$  is derived from a planar net and planar nets are assumed non-degenerate,  $\dim \text{span}_{\mathbb{C}}\{f, f_1, f_2, f_{12}\} = 3$ . As  $\{f, f_1, f_2, f_{12}\}$  are real points with respect to  $j$ ,  $j$  acts as a real structure on their span. If non-empty, the real set corresponding to  $j$  has maximum real dimension 3. By construction the real set of  $\text{span}_{\mathbb{C}}\{f, f_1, f_2, f_{12}\}$  is non-empty. ■

Hence, now consider  $\phi$  to be a real planar net. Let  $[f], [f_1], [f_2], [f_{12}]$  be vertices of an elementary face, then  $[f], [f_1], [f_2]$  define a circle in  $S^4$  corresponding to  $\text{span}_{\mathbb{C}}\{f_1, f_2, f_3\}$  by Theorem 2.3.24. This circle is contained in  $S$  by construction. But then  $f_{12} \in \text{span}_{\mathbb{C}}\{f_1, f_2, f_3\}$  is a real point. Hence  $[f], [f_1], [f_2], [f_{12}]$  lie on a circle in  $S$ . A circle is an irreducible subquadric of the quadric surface  $S$ , hence  $\phi$  is a real quadric planar net in  $S^2$ , otherwise known as a “circular net.”

**Definition:** (CIRCULAR NET) Let  $\phi : \mathbb{Z}^2 \rightarrow Q_S = \{S, Sj\}^\perp \cap Kl$  be a planar net with the property that  $\phi(m, n) \in S, \forall (m, n) \in \mathbb{Z}^2$ , then  $\phi$  is a circular net in the two-sphere  $S$ .

Now, recalling the identification of  $S$  with  $\mathbb{C} < \mathbb{H}$  :

**Lemma 3.4.10** *Real quadric planar nets in  $Q_S$  lift to circular nets in  $\mathbb{C}$ .*

**Proof.** Let  $[f], [f_1], [f_2], [f_{12}]$  be vertices of an elementary face of a real quadric planar net in  $Q_S$ , thus they are incident to a real circle contained in  $S \subset Q_S$ . Then, by Theorem 2.3.27 their cross-ratio in  $\mathbb{HP}^1$  is real valued. Hence, their representatives in  $\mathbb{HP}^1$  are also circular. ■

One could have defined circular nets in  $\mathbb{C}$  purely geometrically as nets of circles whose intersection points correspond to a  $\mathbb{Z}^2$  lattice i.e. without reference to planar nets or quadrics. This result shows that circular nets are in fact “planar nets” viewed in the proper setting. One may now also interchange between circular nets and real quadric planar nets in  $Q_S$  as they are completely equivalent.



**SQUARE CIRCLES:** Consider the following example.

**Lemma 3.4.11** *Let  $a, b, c, d$  be vertices of an elementary face of a circular in  $\mathbb{C}$ , then  $[f], [f_1], [f_2], [f_{12}]$  are Möbius (conformally) equivalent to a square if and only if  $[a, b, c, d] = -1$ .*

**Proof.** Compute the cross-ratio of a square. Then the cross-ratio is a Möbius invariant.

■

Thus, one could say that a circular net where the cross-ratio of each face is  $-1$  is a “discrete conformal by map” with the idea that each face corresponds to an “infinitesimal square” of a conformal map from  $\mathbb{C} \rightarrow \mathbb{C}$ .

The existence of such square circular nets is shown by a quick consideration of the initial value problem. Consider the initial data of a circular net defined along  $\{(m, 0)\} \cap \{(0, n)\} \subset \mathbb{Z}^2$ . Beginning at  $(0, 0)$ , the initial circle is defined by the initial data over  $\{(0, 1), (0, 0), (0, 1)\} \rightarrow \{x_1, x_0, x_2\} \subset \mathbb{C}$ , as three points define a circle. Now, given three points in  $\mathbb{C}$  and a cross-ratio  $\lambda$  there is a unique point  $x$  such that  $[a, b, c, x] = \lambda$  given by

$$x = \frac{a(b-c)\lambda + c(a-b)}{(b-c)\lambda + (a-b)}$$

Hence, choosing  $\lambda = -1$  defines the final point  $x_{12}$  of the initial face of a circular net by

$$x_{12} = \frac{x_1(x_2 - x_0) + x_2(x_0 - x_1)}{(x_2 - x_0) + (x_1 - x_0)}$$

and the process may be extended to define the entire circular net over  $\mathbb{Z}^2$  along horizontal and vertical strips.

### 3.4.3 Real cross-ratio system.

In general, a circular net in  $\mathbb{C}$  can be described in terms of a real cross-ratio function  $\lambda : \mathbb{Z}^2 \rightarrow \mathbb{R} \subset \mathbb{C}$  as shown by the initial value problem in Theorem 3.4.5. Equivalently by Theorem 2.3.27, a real quadric planar net in  $Q_S$  can be described in terms of the same real cross-ratio function.

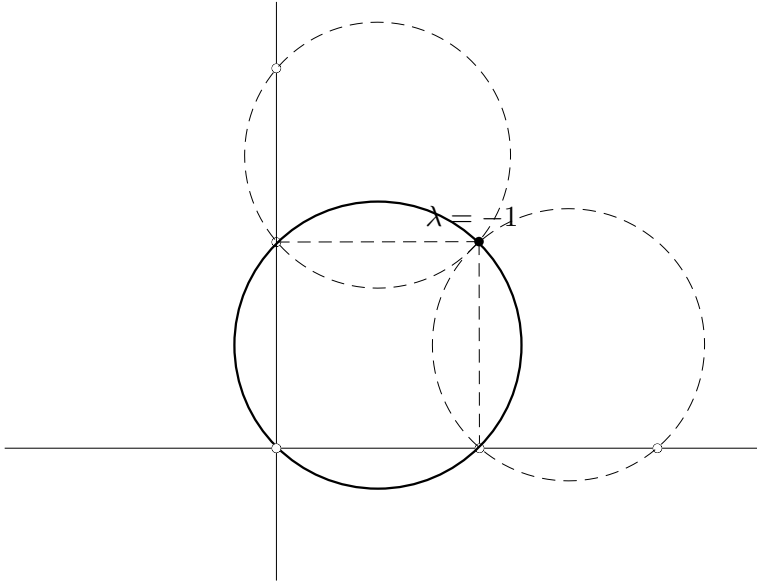

**Figure 21.** Initial value problem for circular nets.

Consider the initial value problem again: given  $\{x_1, x_0, x_2\}$ , a cross-ratio  $\lambda$  defines a fourth point  $x_{12}$  such that

$$[x_1, x_0, x_2, x_{12}] = \lambda.$$

**Proposition 3.4.12** *Let  $x_1, x_0, x_2, x_{12} \in \mathbb{CP}^1$  and  $\lambda \in \mathbb{C}$  such that  $[x_1, x_0, x_2, x_{12}] = \lambda$ .*

*Then, there exists a Möbius transformation  $L(\lambda; x_0, x_1)$  of  $\mathbb{CP}^1$  such that*

$$x_{12} = L(\lambda; x_0, x_1)(x_2)$$

**Proof.**

First, choose an affine chart so that  $\{x_1, x_0, x_2, x_{12}\} \mapsto \{\infty, 0, \tilde{x}_2, \tilde{x}_{12}\}$ . Then

$$[\infty, 0, \tilde{x}_2, \tilde{x}_{12}] = \lambda,$$

implies

$$\begin{bmatrix} \tilde{x}_{12} \\ 1 \end{bmatrix} = \begin{bmatrix} 1 & \lambda \\ 0 & 1 \end{bmatrix} \begin{bmatrix} \tilde{x}_2 \\ 1 \end{bmatrix},$$

$$\tilde{x}_{12} = L(\lambda; 0, \infty)(\tilde{x}_2).$$

Finally, changing coordinates back to the original chart preserves the cross-ratio and one obtains:

$$\begin{bmatrix} x_{12} \\ 1 \end{bmatrix} = \begin{bmatrix} x_1 & x_0 \\ 1 & 1 \end{bmatrix} \begin{bmatrix} 1 & \lambda \\ 0 & 1 \end{bmatrix} \begin{bmatrix} (x_1 - x_0)^{-1} & -x_0(x_1 - x_0)^{-1} \\ -(x_1 - x_0)^{-1} & x_1(x_1 - x_0)^{-1} \end{bmatrix} \begin{bmatrix} x_2 \\ 1 \end{bmatrix}$$

so that

$$x_{12} = L(\lambda; x_0, x_1)(x_2).$$

■

Thus,  $\lambda : \mathbb{Z}^2 \rightarrow \mathbb{R}$  defines a circular net in  $\mathbb{C}$ , with initial data specified along  $(\mathbb{Z}, 0) \cup (0, \mathbb{Z}) \subset \mathbb{Z}^2$ . Another way of imagining this is to consider the initial data on the axis  $(\mathbb{Z}, 0)$  as a discrete curve. Now, choosing a value  $x(0, 1)$  for  $(0, 1)$  along with the cross-ratio function defines a new curve  $x$  as the image of  $(\mathbb{Z}, 1)$  where

$$x(n, 1) = L(\lambda(n-1, 0); x(n-1, 0), x(n, 0))(x(n-1, 1))$$

and  $x(\mathbb{Z}, 0)$  is the initial curve. Now, iterating this procedure from the initial point  $x(0, 1)$ , one obtains

$$x(n, 1) = \left( \prod_k L(\lambda(k-1, 0); x(k-1, 0), x(k, 0)) \right) x(0, 1)$$

for  $k$  from  $1 \rightarrow n$ .

Now, one can specialize the circular net system further by choosing special functions  $\lambda : \mathbb{Z}^2 \rightarrow \mathbb{R}$ . One obvious choice would be to consider those given by  $\lambda$  constant e.g.  $\lambda = -1$ .

#### 3.4.4 Extending the real cross-ratio system to $\mathbb{Z}^3$

It is possible, given the Real Hexahedron Lemma, to extend a  $\mathbb{Z}^2$ -circular net to a  $\mathbb{Z}^3$ -circular net. Thus, each face of the  $\mathbb{Z}^3$  is associated to a circle in  $\mathbb{C}$ .

Given an elementary hexahedron of  $\mathbb{Z}^3$ , the conclusion of the real Hexahedron Lemma guarantees that, given five circles intersecting along the eight points according to the pattern of a circular net, there is a sixth circle corresponding to the “top” of the hexahedron.

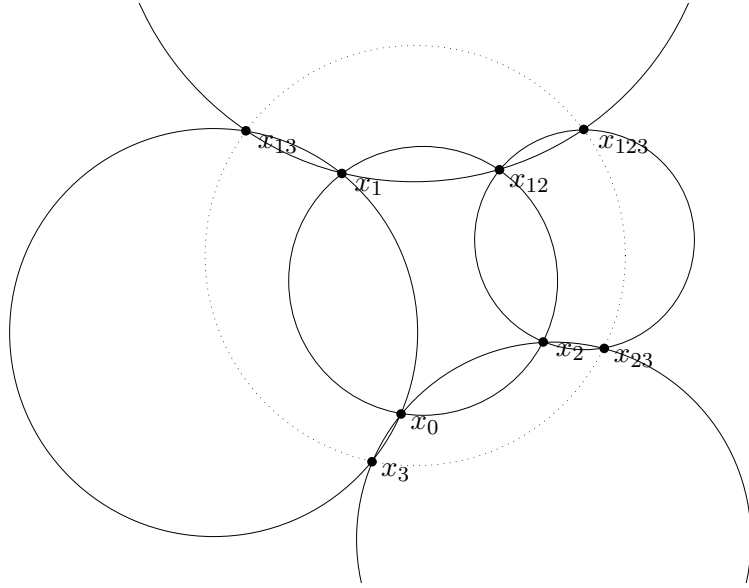

**Figure 22. Miquel configuration of circles.**

Stated in terms of incidence of circles on the plane this is exactly the classical Miquel configuration of circles[7]. Thus, given Miquel’s theorem one may prove the hexahedron lemma for circular nets in  $\mathbb{C}$  irregardless to the real quadric planar system. This is all equivalent to Theorem 3.4.6 which constrains the cross-ratios of the faces of an elementary hexahedron by

$$\lambda_{12}\tau_3(\lambda_{12})\lambda_{23}\tau_1(\lambda_{23}) = \lambda_{13}\tau_2(\lambda_{13}). \quad (3.23)$$

Now, suppose one wanted to extend the constant cross-ratio system to the  $\mathbb{Z}^3$ -lattice so that each family of parallel levels of  $\mathbb{Z}^3$  have identical and constant cross-ratios. This is equivalent [17] to a further condition on the cross-ratios of the elementary hexahedron:

$$\lambda_{12}\lambda_{23} = \lambda_{13}. \quad (3.24)$$

Notice that, as a consequence of (3.23), the condition  $\lambda = -1$  cannot be applied to every level of the  $\mathbb{Z}^3$  lattice. Hence a system defined by a constant cross-ratio equal to  $-1$  does not satisfy the previous “discretization principles” and does not represent a fundamental reduction of the planar quadrilateral net. However, (3.23) is a property of a further geometric reduction of the quadric planar system [7].

**Definition:** Let  $\phi$  for a quadric planar  $\mathbb{Z}^3$ -net, then  $\phi$  is a generalized discrete isothermic net if and only if for a given elementary hexahedron  $\{\phi_0, \phi_{12}, \phi_{23}, \phi_{13}\}$  are planar and that plane defines an irreducible one-dimensional quadric.

**Remark:** It is clear that the generalized discrete isothermic net reduces via a real structure in the same fashion as the planar quadric system so that in the example of circular nets, the generalized isothermic net on  $Q_S$  will induce a reduction of the real planar quadric system on  $S^2 \subset Q_S$  defining “isothermic nets” in  $\mathbb{C}$ .

**Proposition 3.4.13** *Let  $\phi$  for a generalized isothermic net, then  $\{\phi_{123}, \phi_1, \phi_2, \phi_3\}$  are planar and that plane defines an irreducible one-dimensional quadric.*

One may then show that the constant cross-ratio  $\mathbb{Z}^3$ -net with equal opposite faces is an example of a generalized isothermic net so that the defining condition says that  $\{\phi_0, \phi_{12}, \phi_{23}, \phi_{13}\}$  are circular. The addition of this property and associated corollary to the Miquel configuration is exactly the classical Clifford configuration of circles. Thus, from the Clifford configuration of circles comes the Hexahedron lemma for generalized discrete isothermic nets.

### 3.4.5 The complex cross-ratio system

Consider the Hexahedron Lemma in terms of the Möbius transformations of Proposition 3.4.12. It is clear that from the Hexahedron Lemma

$$x_{123} = L(\nu; x_1, x_{13})L(\lambda; x_0, x_1)(x_{12}) = L(\lambda; x_3, x_{13})L(\nu; x_0, x_3)(x_{12})$$

Following the proof of Prop. 3.4.12 with appropriate normalization this result may be lifted to representations of 'L' in  $GL(2, \mathbb{C})$ . Thus, one obtains the following result for isothermic nets in  $\mathbb{C}$  :

**Theorem 3.4.14 (ZERO-CURVATURE REPRESENTATION)** *Let  $\phi$  be an isothermic  $\mathbb{Z}^3$ -net in  $\mathbb{C}$ , then  $\phi$  is described by a “zero-curvature equation” in  $GL(2, \mathbb{C})$  associated*

to each elementary hexahedron:

$$L(\nu; x_1, x_{13})L(\lambda; x_0, x_1) = L(\lambda; x_3, x_{13})L(\nu; x_0, x_3).$$

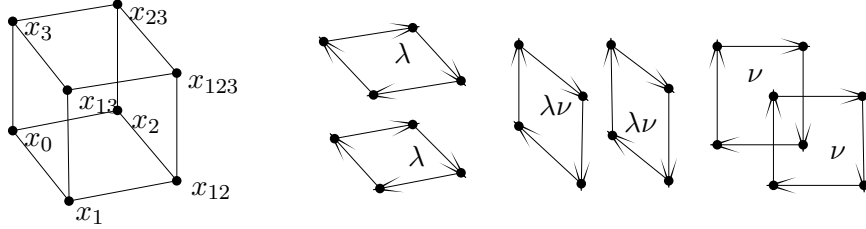

**Figure 23. Cross-ratio constraint for zero-curvature representation.**

Now, the zero-curvature equation for initial data

$$\{x_0, x_1, x_2, x_{12}\}, \{x_0, x_2, x_3, x_{23}\}, \{x_0, x_1, x_3, x_{13}\}$$

defines a unique eighth point  $x_{123}$  completing the hexahedron. By inspection of Proposition 3.4.12 it is clear that the zero-curvature representation on  $\mathbb{C}$  does not depend upon choosing real cross-ratios; in the end it is simply a matrix identity. This may be verified by a lengthy but straightforward computation. Thus, it is possible to define a  $\mathbb{Z}^3$ -net in  $\mathbb{C}$  by choosing constant cross-ratio functions  $\lambda : (\mathbb{Z}, \mathbb{Z}, 0) \rightarrow \mathbb{C}$ ,  $\nu : (0, \mathbb{Z}, \mathbb{Z}) \rightarrow \mathbb{C}$ , and  $\mu : (\mathbb{Z}, 0, \mathbb{Z}) \rightarrow \mathbb{C}$  with the constraint that  $\mu = \lambda\nu$ . The zero-curvature representation then proves consistency for initial data specified on those three coordinate planes of the lattice.

**Definition:** Let initial data be specified on  $(\mathbb{Z}, 0) \cup (0, \mathbb{Z}) \subset \mathbb{Z}^2$ , then, choosing  $\lambda \in \mathbb{C}$ ,

$$[x_1, x_0, x_2, x_{12}] = \lambda$$

for every elementary face of  $\mathbb{Z}^2$  defines a complex cross-ratio net in  $\mathbb{C}$  that may be extended to a  $\mathbb{Z}^3$ -net for arbitrary choice of  $\nu \in \mathbb{C}$ .

The complex cross-ratio system has been defined through a zero-curvature equation, independent of  $Q_S$  and any discrete planar net. I will now show that the complex planar quadric net in  $Q_S$  is equivalent to a complex cross-ratio system in  $\mathbb{C}$ .

It has already been established in Lemma 3.4.10 that real planar quadric nets in  $Q_S$  define circular (real cross-ratio) nets in  $\mathbb{C}$ . Real planar quadric nets were defined as real reductions of *complex* planar quadric nets in  $Q_S$ , thus they are planar quadric nets where the Steiner cross-ratio of each face is real. It suffices to consider the case where the Steiner cross-ratio of a face is a complex number.

Let three real points  $\{x_0, x_1, x_2\} \subset S^2 \subset Q_S$  be given as in a planar quadric net. Three points define a projection plane, whose intersection  $\Xi$  with  $Q_S$  is a one-dimensional quadric. The real set of this quadric consists of the points of the circle in  $S^2$  defined by  $\{x_0, x_1, x_2\}$ . These real points are parameterized by real Steiner cross-ratios defined with respect to  $\Xi$ . Let the point  $x_k \in S$  have coordinate  $x_k$  in  $\mathbb{C}$ , then  $x_{kj} \in S_j$  has coordinate  $\bar{x}_k$  in  $\mathbb{C}$ .

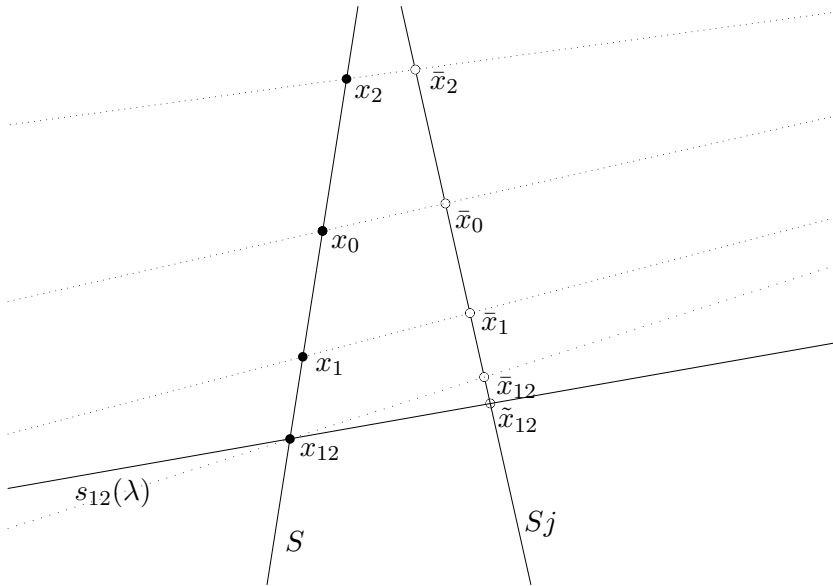

**Figure 24. Non-real Steiner cross-ratio of four points in  $Q_S \subset Kl$ .**

Suppose  $\lambda \in \mathbb{C}$  is not real. Then, there is a unique point  $s_{12}(\lambda)$  such that the Steiner cross-ratio

$$[x_1, x_0, x_2, s_{12}(\lambda)] = \lambda.$$

Now,  $s_{12}(\lambda) \in Q_S$ , hence  $s_{12} < \mathbb{C}\mathbb{P}^3$  is incident to  $S$  and  $Sj$ . Let  $s_{12} \cap S = x_{12}$  and  $s_{12} \cap Sj = \tilde{x}_{12}$ . For each  $\lambda \in \mathbb{C}$  there is a corresponding point in  $\Xi$  and, as  $\Xi$  is irreducible, no two such points may have line representatives incident in  $\mathbb{C}\mathbb{P}^3$ . Thus, the cross-ratio  $\lambda \in \mathbb{C}$  parameterizes the points of  $\mathbb{C}$  provide one chooses either  $S$  or  $Sj$ . Now, choosing the  $S$  and thus the representative  $x_{12} \in \mathbb{C}$  of  $s_{12}(\lambda)$ , what remains to be shown is that in  $\mathbb{C}$

$$[x_1, x_0, x_2, x_{12}] = \lambda.$$

But, this is exactly the result of Theorem 2.3.28. Thus, with a choice of circle in  $\mathbb{C}$ , the associated Steiner cross-ratio on  $\Xi$  and the cross-ratio  $\mathbb{C}$  are in exact correspondence.

However,  $x_{12} \in \mathbb{C}$  is the coordinate of a point in  $S$ , whereas  $s_{12}(\lambda)$  is a two-sphere in  $S^4$  which half-touches  $S$  and  $Sj$ . In order to proceed with the initial value problem explained previously it remains to be shown that cross-ratio in  $\mathbb{C}$  with respect to the circle  $\{x_1, x_{12}, y\}$  for some arbitrary point  $y \in \mathbb{C}$ , and the Steiner cross-ratio with respect to  $\{x_1, s_{12}(\lambda), y\}$  are equivalent.



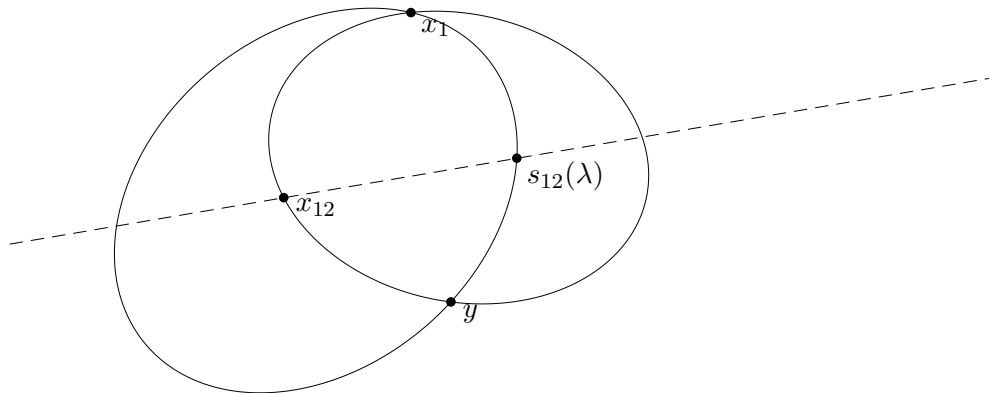

**Figure 25. A question.**

## BIBLIOGRAPHY

- [1] **Alexander I. Bobenko** Surfaces from Circles. *Lecture Notes for Oberwolfach Seminar "Discrete Differential Geometry", June 2004* <http://front.math.ucdavis.edu/0707.1318>.
- [2] **Alexander I. Bobenko; S. P. Tsarev** Curvature line parametrization from circle patterns. <http://front.math.ucdavis.edu/0706.3221>
- [3] **Alexander I. Bobenko; Yuri B. Suris** Isothermic surfaces in sphere geometries as Moutard nets. *Proc. Royal Soc. A, 2007, 463, p. 3171-3193* <http://front.math.ucdavis.edu/0610.5434>
- [4] **Alexander I. Bobenko; Yuri B. Suris** On organizing principles of Discrete Differential Geometry. Geometry of spheres. *Russian Math. Surveys, 2007, 62, p. 1-43* <http://front.math.ucdavis.edu/0608.5291>
- [5] **Alexander I. Bobenko; Yuri B. Suris** Discrete differential geometry. Consistency as integrability. *"Discrete Differential Geometry. Integrable Structure", Graduate Studies in Mathematics, Vol. 98. AMS, 2008. xxiv+404 pp.* <http://front.math.ucdavis.edu/0504.5358>
- [6] **Alexander I. Bobenko; Tim Hoffmann; Boris A. Springborn** Minimal surfaces from circle patterns: Geometry from combinatorics. *Ann. of Math. 164:1 (2006), 231-264* <http://front.math.ucdavis.edu/0305.5184>
- [7] **Adam Doliwa** Generalized isothermic lattices. <http://front.math.ucdavis.edu/0611.6418>
- [8] **A. Doliwa; P. M. Santini** Integrable Systems and Discrete Geometry. *Elsevier's Encyclopedia of Mathematical Physics* <http://front.math.ucdavis.edu/0504.6441>.
- [9] **Adam Doliwa** Discrete asymptotic nets and W-congruences in Plucker line geometry. *J. Geom. Phys. 39 (2001) 9-29* <http://front.math.ucdavis.edu/9909.6465>.
- [10] **A. Doliwa; P. M. Santini** Integrable Discrete Geometry: the Quadrilateral Lattice, its Transformations and Reductions. *Proceedings from the Conference "Symmetries and Integrability of Difference Equations III", Sabaudia, 1998* <http://front.math.ucdavis.edu/9907.6464>.
- [11] **Adam Doliwa** Quadratic reductions of quadrilateral lattices. *J. Geom. Phys. 30 (1999) 169-186* <http://front.math.ucdavis.edu/9802.6461>.

- [12] **A. Doliwa; P. M. Santini; M. Manas** Transformations of Quadrilateral Lattices. *J. Math. Phys.* 41 (2000) 944-990 <http://front.math.ucdavis.edu/9712.6467>
- [13] **Francis Burstall; Franz Pedit; Ulrich Pinkall** Schwarzian Derivatives and Flows of Surfaces. *Contemp. Math.*, 308 (2002) 39-61 <http://front.math.ucdavis.edu/0111.5169>
- [14] **Francis Burstall; D. Ferus; K. Leschke; Franz Pedit; Ulrich Pinkall** Conformal Geometry of Surfaces in the 4-Sphere and Quaternions. *Lecture Notes in Mathematics vol 1772, Springer-Verlag, 2002* <http://front.math.ucdavis.edu/0002.5075>.
- [15] **U. Hertrich-Jeromin; I. McIntosh; P. Norman; Franz Pedit** Periodic discrete conformal maps. <http://front.math.ucdavis.edu/9905.5112>.
- [16] **F. E. Burstall; U. Hertrich-Jeromin** The Ribaucour transformation in Lie sphere geometry. *Differential Geom. Appl.* 24 (2006) 503-520 <http://front.math.ucdavis.edu/0407.5244>
- [17] **Udo Hertrich-Jeromin; Tim Hoffmann; Ulrich Pinkall** A discrete version of the Darboux transform for isothermic surfaces. *sfb288-239* <http://front.math.ucdavis.edu/9611.5109>
- [18] **Udo Hertrich-Jeromin** Transformations of discrete isothermic nets and discrete cmc-1 surfaces in hyperbolic space. *Manuscripta Math.* 102, 465-486 (2000) <http://front.math.ucdavis.edu/9908.5161>
- [20] **Christoph Bohle** Möbius invariant flows of tori in  $S^4$ . *Doctoral Thesis at Technische Universität Berlin* [http://edocs.tu-berlin.de/diss/2003/bohle\\_christoph.htm](http://edocs.tu-berlin.de/diss/2003/bohle_christoph.htm)
- [21] **Thorsten Senkbeil** Discrete Curves in  $\mathbb{R}^4$ . *Vordiplom Thesis at Technische Universität Berlin*
- [22] **R. S. Ward; Raymond O. Wells, Jr** Twistor Geometry and Field Theory. *Cambridge Monographs on Mathematical Physics*
- [23] **R. Milson** An Overview of Lie's Line-Sphere Correspondence. *The Geometrical Study of Differential Equations; eds. Leslie, Thobart*