

5-2010

Geometric and Combinatorial Aspects of 1-Skeleta

Chris Ray McDaniel

University of Massachusetts Amherst

Follow this and additional works at: https://scholarworks.umass.edu/open_access_dissertations



Part of the [Mathematics Commons](#), and the [Statistics and Probability Commons](#)

Recommended Citation

McDaniel, Chris Ray, "Geometric and Combinatorial Aspects of 1-Skeleta" (2010). *Open Access Dissertations*. 250.
https://scholarworks.umass.edu/open_access_dissertations/250

This Open Access Dissertation is brought to you for free and open access by ScholarWorks@UMass Amherst. It has been accepted for inclusion in Open Access Dissertations by an authorized administrator of ScholarWorks@UMass Amherst. For more information, please contact scholarworks@library.umass.edu.

GEOMETRIC AND COMBINATORIAL
ASPECTS OF 1-SKELETA

A Dissertation Presented

by

CHRIS R. MCDANIEL

Submitted to the Graduate School of the
University of Massachusetts Amherst in partial fulfillment
of the requirements for the degree of

DOCTOR OF PHILOSOPHY

May 2010

Department of Mathematics and Statistics

© Copyright by Chris R. McDaniel 2010

All Rights Reserved

GEOMETRIC AND COMBINATORIAL
ASPECTS OF 1-SKELETA

A Dissertation Presented

by

CHRIS R. MCDANIEL

Approved as to style and content by:

Tom Braden, Chair

Eduardo Cattani, Member

Paul Gunnells, Member

Ileana Streinu, Member

George Avrunin, Department Head
Mathematics and Statistics

Dedication

To Oskar and Sarah.

ACKNOWLEDGMENTS

I would like to thank the following people.

Tom Braden: for teaching me about the connections between “toric topology” and combinatorial geometry and for introducing me to the wonderful world of 1-skeleta. For all of the time he spent carefully reading and listening to (and poking holes in) my arguments. For teaching me how to communicate mathematics and for urging me to talk with other mathematicians. In general, I thank him for teaching me how to be a mathematician. On a more personal note, I thank him for his patience with me as I struggled through the tough parts. Also for his encouragement and inspiration, without which I am not sure I would have made it.

Eduardo Cattani: for stimulating conversations and advice in regards to the hard Lefschetz stuff. Also for his patience in listening to me bumbling around trying to explain my mathematics.

Victor Guillemin and Catalin Zara: for helpful conversations and lessons. In particular for inviting me to participate in their weekly seminar on GKM fiber bundles in Fall 2008.

Eric Sommers: for enlightening conversations regarding root systems, and for lessons in algebra in general. I also owe him a special thanks for the encouragement, moral support, and the general comradery that he showed to us grad students over the years.

Cat, Mike, Molly, Pat and Sarah: for their friendship, love and support.

Finally, I would like to thank the Mathematics Department at the University of Massachusetts for all their support during the school year, and over several summers.

ABSTRACT

GEOMETRIC AND COMBINATORIAL

ASPECTS OF 1-SKELETA

MAY 2010

CHRIS R. MCDANIEL, B.S., UNIVERSITY OF WASHINGTON

Ph.D., UNIVERSITY OF MASSACHUSETTS AMHERST

Directed by: Professor Tom Braden

In this thesis we investigate 1-skeleta and their associated cohomology rings. 1-skeleta arise from the 0- and 1-dimensional orbits of a certain class of manifold admitting a compact torus action and many questions that arise in the theory of 1-skeleta are rooted in the geometry and topology of these manifolds. The three main results of this work are: a lifting result for 1-skeleta (related to extending torus actions on manifolds), a classification result for certain 1-skeleta which have the Morse package (a property of 1-skeleta motivated by Morse theory for manifolds) and two constructions on 1-skeleta which we show preserve the Lefschetz package (a property of 1-skeleta motivated by the hard Lefschetz theorem in algebraic geometry). A corollary of this last result is a conceptual proof (applicable in certain cases) of the fact that the coinvariant ring of a finite reflection group has the strong Lefschetz property.

TABLE OF CONTENTS

ACKNOWLEDGMENTS	v
ABSTRACT	vi
LIST OF FIGURES	ix
INTRODUCTION	1
CHAPTER	
1. PRELIMINARY NOTIONS AND NOTATIONS	8
1.1 1-Skeleta	9
1.2 Examples	12
1.3 Sub-skeleta, Holonomy and Straightness	17
1.4 Polarizations	22
1.5 Cohomology Rings	25
1.6 Morphisms	27
1.7 1-skeleta in Nature	30
2. PROJECTIONS AND LIFTING	38
2.1 Projections, Simple Polytopes, and a Lifting Problem	39
2.1.1 Projections	39
2.1.2 Polytopes and Projected Polytopes	42
2.2 Reduction	50
2.2.1 Reducible 1-Skeleta	50
2.2.2 Pre-1-Skeleta and Generalized 1-Skeleta	53
2.2.3 Reduction and Cross-Sections	55
2.3 Product Constructions and the Blow-Up	63
2.3.1 Direct Product	63
2.3.2 Tilted Product	64
2.3.3 Blow-Up	67
2.4 The Main Result	75
2.4.1 The Easy Part	76
2.4.2 Lifting Cross-Sections	78
2.4.3 Cutting	92
2.5 Concluding Remarks	99

3. MORSE PROPERTIES	103
3.1 The Morse Package	104
3.1.1 Holonomy, Normal Straight-ness, and Equivariant Thom Classes	110
3.1.2 Straight-ness, Top Classes, and Localization	114
3.2 Planar 1-Skeleta	123
3.2.1 The 3-Valent Case	124
3.2.2 Crossed-Regular Polygons	130
3.3 Concluding Remarks	140
4. STRONG LEFSCHETZ PROPERTIES	142
4.1 Preliminaries and Motivation	144
4.2 Fiber Bundles	147
4.2.1 Leray-Hirsch Theorem	158
4.2.2 Lefschetz Package for Fiber Bundles	166
4.3 The Blow-Up	180
4.3.1 Cohomology of the Blow-Up	182
4.3.2 Lefschetz Package for the Blow-Up	186
4.4 Applications To Coinvariant Rings	196
4.4.1 Preliminaries	196
4.4.2 Leray-Hirsch Decomposition	211
4.5 Concluding Remarks	218
BIBLIOGRAPHY	221

LIST OF FIGURES

Figure	Page
1. axial function	11
2. a polygon	13
3. projected simple polytope	14
4. octahedron in special position	15
5. 3-valent planar 1-skeleton	15
6. 1-skeleton of finite reflection group S_3	15
7. crossed-regular polygon	16
8. a non-convex polygon is not a 1-skeleton	16
9. an embedding	17
10. normally straight, but not level	21
11. no polarization	23
12. an embedding is an equivariant class	27
13. restriction to the left factor is not surjective	30
14. non-cyclic and not non-cyclic	41
15. a simple 3-polytope and its projection	44
16. enough 2-faces?	52
17. the c -cross-section	58
18. direct product	64
19. tilted product	66
20. blow-up along a sub-skeleton	68
21. passage over a critical point	91

22. cutting	96
23. A 3-Independent 1-Skeleton That Does Not Lift.	98
24. reducible 1-skeleton, 2-faces not straight	99
25. Decreasing the m-height of a loop on a 2-slice	122
26. A “Thom-Class” on an arbitrary loop	125
27. A CS-1-Skeleton	130
28. A Crossed-Regular 8-gon.	131
29. The unique vertex q_J	134
30. An outer crossed-regular 8-gon.	138
31. The 3 cases	139
32. 4-valent, Straight, Non-Morse.	140
33. a fibration.	151
34. a fiber bundle	153
35. a pseudo-fiber bundle	154
36. 1-skeleton of S_3	207

INTRODUCTION

In this thesis we study certain aspects of 1-skeleta and their associated cohomology rings. A 1-skeleton is a discrete-geometric object consisting of a finite connected regular graph together with a certain assignment of 1-dimensional linear subspaces (of some ambient real vector space) to all of the edges. The equivariant cohomology ring of a 1-skeleton is a sub-ring of the ring of functions mapping the vertex set of the graph to a polynomial ring, cut out by conditions determined by the assignment of lines to edges as above. The ordinary cohomology ring is a quotient of the equivariant cohomology ring by a particular linear system of parameters. 1-skeleta arise naturally in differential geometry from the 0- and 1-dimensional orbits on certain smooth compact manifolds admitting smooth compact torus actions. In some cases the cohomology rings associated to the 1-skeleton are isomorphic to the (topological) cohomology rings of the corresponding manifold.

In [10], Goresky, Kottwitz and MacPherson study certain spaces (possibly singular) admitting an action of a compact torus T (called T -spaces for short). They observe that the 0- and 1-dimensional orbits fit together to form a graph and the weights of the T -action at the fixed points assign directions to the edges of the graph. Moreover they show, following Chang and Skjelbred in [5], that in certain cases the equivariant and ordinary cohomology of the T -space is completely determined by this “linear graph” (called a 1-skeleton if the T -space is non-singular).

There are two famous classes of T -spaces which fit the model in [10] particularly well:

projective toric varieties and Schubert varieties. For a projective toric variety, *all* of the T -orbits fit together nicely to form a polytope. The 1-skeleton of a smooth projective toric variety is the 1-skeleton of the associated simple polytope. Schubert varieties are sub-varieties (often singular) of certain smooth projective varieties called flag varieties. The 1-skeleta of these flag varieties are built from the data encoded in the associated Weyl groups and root systems. Their underlying graphs are often referred to as Bruhat graphs and the corresponding assignment of directions to the edges comes from the root system associated to the flag variety.

Soon after the appearance of [10], Guillemin and Zara defined 1-skeleta in an abstract combinatorial setting. They restricted their attention to the smooth case and coined the term *GKM manifold* (or *GKM T -manifold* if we want to remember the torus). They showed that many topological theorems about these manifolds have combinatorial proofs in this abstract setting. In a series of papers [13], [14], and [16] Guillemin and Zara give an extensive study of 1-skeleta and their cohomology rings; they introduce many notions and techniques, motivated by (symplectic) geometry but applicable in the general case.

The goal of this thesis is to continue to develop and study these objects in the abstract setting following Guillemin and Zara. There are essentially three aspects that we focus on here. First we study certain geometric properties of 1-skeleta dealing with projections and lifting; this is related to extending torus actions on GKM manifolds. Next we study the additive structure of the equivariant cohomology ring of a 1-skeleton; the techniques used here, following Guillemin and Zara, have analogues in Morse theory on GKM manifolds. Finally we study the strong Lefschetz properties of the ordinary cohomology ring of a 1-skeleton; this deals with the multiplicative structure of the cohomology ring and is related to the hard Lefschetz theorem in algebraic geometry. Below we give a brief description of the main results of this thesis.

Geometric Aspects: Projection and Lifting

A 1-skeleton is a regular connected graph whose edges are assigned lines in some ambient real vector space in a nice way. There is a projection operation which takes a 1-skeleton in some vector space and produces a 1-skeleton in a quotient vector space. A particularly nice class of 1-skeleta on which this operation applies are those coming from simple polytopes; the result of the projection operation in this case is a 1-skeleton that we call a projected simple polytope. Geometrically, projection corresponds to restricting the action of T on the GKM T -manifold.

One can try to go backwards and determine when a given 1-skeleton in a vector space is a projection of a 1-skeleton in a larger vector space. While the general problem remains open, we give a partial answer here. We specialize the problem to projections of certain 1-skeleta whose edge directions form a basis in the ambient vector space. We are then able to classify projections of such 1-skeleta. See Chapter 2, Theorem 2.4.2. As a corollary we are able to classify those 1-skeleta that are projections of simple polytopes. See Chapter 2, Corollary 2.4.9.

Algebraic Aspects: Additive Structure

The equivariant cohomology ring of a 1-skeleton is a finitely generated module over a polynomial ring. One of the motivating questions behind this thesis is “For which 1-skeleta is the equivariant cohomology a free module?”. While this question remains open, Guillemin and Zara in [16] give a sufficient condition for freeness in a property of 1-skeleta that they call the “Morse package”. One can then ask “Which 1-skeleta have the Morse package?”. In [16] Guillemin and Zara essentially show that understanding 1-skeleta with the Morse package is equivalent to understanding *planar* 1-skeleta with the Morse package.

While the general problem of determining exactly which planar 1-skeleta have the Morse package remains open, we give some partial results in this direction. In particular we are able to classify all 3-valent 1-skeleta which have the Morse package. See Chapter 3, Theorem 3.2.1. In addition we give some examples which may serve as a guide in understanding the higher valency cases.

Algebraic Aspects: Multiplicative Structure

The cohomology ring of a 1-skeleton is a finite dimensional graded ring and in many cases it has symmetric Betti numbers. One can ask if there exists an element L in degree one such that multiplication by powers of L has maximal rank (viewed as a linear map between the graded pieces). If so, the cohomology ring is said to have the “strong Lefschetz property” and the 1-skeleton is said to have the “Lefschetz package”. One of the motivating questions here is “Which 1-skeleta have the Lefschetz package?”.

In Chapter 4 we give some new results in this direction in the way of “Lefschetz constructions”. There are two constructions on 1-skeleta that we investigate here: fiber bundles and blow-ups. The notion of a fiber bundle of 1-skeleta was introduced by Guillemin, Sabatini and Zara in [28]; a fiber bundle is a “twisted product”: it has a base (the “straight” factor), a fiber (the “twisted” factor) and a total space (the “twisted product” of the two factors). We show that if the base 1-skeleton and the fiber 1-skeleton both have the Lefschetz package, then the total space 1-skeleton also has the Lefschetz package. See Chapter 4, Theorems 4.2.16 and 4.2.17. The blow-up is a construction introduced by Guillemin and Zara in [14] that takes a 1-skeleton and a sub-skeleton and produces a new 1-skeleton. We show that if the original 1-skeleton and sub-skeleton have the Lefschetz package, then the blow-up 1-skeleton also has the Lefschetz package. See Chapter 4, Theorems 4.3.5 and 4.3.6.

In case the 1-skeleton comes from a smooth projective variety, the hard Lefschetz

theorem from algebraic geometry implies that the cohomology ring of the variety has the strong Lefschetz property, which, in turn, implies that the 1-skeleton has the Lefschetz package. This argument can be applied to show that 1-skeleta of simple polytopes with rational vertices as well as 1-skeleta of Weyl groups (i.e. rational finite reflection groups) have the Lefschetz package. As a first step in trying to understand the Lefschetz package for 1-skeleta, one can try to find a proof of this fact that is completely contained in the 1-skeleton setting; in particular a proof that does not appeal to the hard Lefschetz theorem. Such a proof would have the added benefit (hopefully) of applying to the non-rational 1-skeleta as well, where the hard Lefschetz theorem never applied in the first place. For instance McMullen gave a proof in [22] in the early nineties that 1-skeleta of simple polytopes have the Lefschetz package using only algebra and combinatorics. We use our results on fiber bundles (in particular Theorem 4.2.16) to give a new conceptual proof (applicable in all types except E_6 , E_7 , E_8 , F_4 and H_4) of the fact that 1-skeleta of finite reflection groups have the Lefschetz package. See Chapter 4, Theorem 4.4.28.

Organization

This thesis is divided into four chapters that are organized as follows.

In Chapter 1 we give the preliminary definitions and notions. We define a 1-skeleton, its cohomology rings, and useful notions such as holonomy, straight-ness, Thom classes, polarizations, and morphisms of 1-skeleta. We also describe how a 1-skeleton arises from a GKM T -manifold after Guillemin and Zara.

In Chapter 2 we define the projection operation on 1-skeleta, formulate the general lifting problem and describe a particular specialization of this problem. We then describe those 1-skeleta whose projections we intend to classify, of which the simple polytopes are a proper subset. After introducing the necessary technical tools we give the statement and proof of our main result. Along the way we define the blow-up construction which

also comes up in Chapter 4.

In Chapter 3 we study the equivariant cohomology ring of a 1-skeleton following Guillemin and Zara ([13], [14] and [16]). We describe the Morse package in detail and state Guillemin and Zara's classification result from [16]. We then proceed to study those planar 1-skeleta that have the Morse package. First we classify those planar 3-valent 1-skeleta with the Morse package using the notion of straightness defined in Chapter 1. Then we introduce an infinite family of (symmetric) planar 1-skeleta, of higher valency in general, and find an infinite sub-family that has the Morse package.

In chapter 4 we introduce the strong Lefschetz terminology and give some background information. We define the notion of a fiber bundle of 1-skeleta and describe a Leray-Hirsch type theorem after Guillemin, Sabatini and Zara in [28]. We then state and prove an algebraic result that allows us to deform the Lefschetz structure on the tensor product of two rings with the strong Lefschetz property. In conjunction with the Leray-Hirsch type theorem above, this will imply our main result for the Lefschetz package on fiber bundles. We review the notion of a blow-up of a 1-skeleton along a sub-skeleton and describe a decomposition theorem for the cohomology ring of the blow-up after Guillemin and Zara in [14]. We then state and prove an algebraic result that allows us to deform the Lefschetz structure on a direct sum of two rings with the strong Lefschetz property. In conjunction with the decomposition theorem above, this will imply our main result for the Lefschetz package on blow-ups.

Finally we give an account of the theory of 1-skeleta applied to finite reflection groups. We begin by reviewing the the basics of the theory of finite reflection groups and their coinvariant rings. We then show how to construct a 1-skeleton from a finite reflection group (together with a fixed associated root system). We relate these two theories by constructing an explicit isomorphism between the coinvariant ring of the finite reflection group and the cohomology ring of the associated 1-skeleton. We then apply our previous

results on fiber bundles to get our main results for the Lefschetz package for 1-skeleta of finite reflection groups; we state these results in terms of coinvariant rings to avoid any unnecessary notation.

We have tried to include lots of examples and figures. We give open questions and problems at the end of each chapter and try to point to avenues of future research. Enjoy.

CHAPTER 1

PRELIMINARY NOTIONS AND NOTATIONS

In this chapter we introduce the basic elements of the theory of 1-skeleta as pertains to this thesis. The theory of abstract 1-skeleta was founded and studied extensively by Guillemin and Zara in a series of papers [13], [14] and [16]. For a certain class of (compact) manifolds admitting a compact torus action, one can construct a 1-skeleton from the 0- and 1-dimensional orbits. Then under the some additional hypotheses a theorem of Goresky, Kottwitz and MacPherson in [10] states that the equivariant cohomology ring can be computed as a “cohomology ring” associated with the 1-skeleton. In [14], Guillemin and Zara introduced 1-skeleta and their associated cohomology rings in an abstract setting together with many useful notions inspired from (symplectic) geometry including connections, holonomy, Thom classes and polarizations. We define these notions here and introduce a few others including compatibility constants, straightness, and morphisms (a notion which also appears in a later paper by Guillemin, Sabatini and Zara, [28]).

This chapter is divided into seven sections. In Section 1 we introduce graphs, axial functions, connections and compatibility constants—all the necessary ingredients to build a 1-skeleton. In Section 2 we pause to look at some examples to give the reader an idea of what we are dealing with here. In Section 3 we introduce the notion of a sub-skeleton and discuss holonomy and straightness conditions on a sub-skeleton. In Section 4 we

introduce the notion of a polarization of a 1-skeleton as well as the combinatorial Betti numbers, an important numerical invariant of a 1-skeleton. In Section 5 we introduce the equivariant and ordinary cohomology rings of a 1-skeleton: these rings play a central role in this thesis. In Section 6 we define morphisms of 1-skeleta. In Section 7 we discuss the class of manifolds alluded to above, known as GKM T -manifolds; we also show how to construct a 1-skeleton from such a manifold.

1.1 1-Skeleta

A graph Γ is a pair (V_Γ, E_Γ) , where V_Γ is a set called the *vertices of Γ* and E_Γ is a set of ordered pairs of vertices denoted \overline{pq} such that $\overline{pq} \in E_\Gamma$ if and only if $\overline{qp} \in E_\Gamma$; these are called the *oriented edges of Γ* . If $e = \overline{pq}$, then its opposite is $\bar{e} = \overline{qp}$; we call p the initial vertex of e and write $i(e) = p$ and call q the terminal vertex and write $t(e) = q$. For each vertex $p \in V_\Gamma$ define $E_p = \{e \in E_\Gamma \mid i(e) = p\}$. We say that Γ is *d-valent* if $|E_p| = d$ for every p . We will say that Γ has constant valency if Γ is *d-valent* for some $d \geq 0$.

Let p and q be vertices of Γ . A *path from p to q* is a sequence of vertices beginning with p and ending with q such that any two consecutive vertices in the path are neighbors; we reserve the greek letter γ to denote a path and we will write

$$\gamma: p \rightarrow \cdots \rightarrow q.$$

We say that a graph Γ is *connected* if for any two vertices $p, q \in V_\Gamma$ there is a path from p to q .

A *sub-graph* of Γ is a graph $\Gamma_0 = (V_0, E_0)$ where $V_0 \subset V_\Gamma$ and $E_0 \subset E_\Gamma$. We say that $\Gamma_0 = (V_0, E_0)$ is the *induced sub-graph on V_0* if for every $e \in E_\Gamma$ such that $i(e), t(e) \in V_0$ we have $e \in E_0$. We use the notation $\Gamma_0 \subset \Gamma$ to denote a subgraph.

Definition 1.1.1. A connection $\theta := \{\theta_e\}_{e \in E_\Gamma}$ on a d -valent graph $\Gamma = (V_\Gamma, E_\Gamma)$ is a collection of maps indexed by the oriented edges of Γ that satisfy the following rules:

1. $\theta_e: E_{i(e)} \rightarrow E_{t(e)}$ is a bijective map
2. $\theta_e = \theta_{\bar{e}}^{-1}$ for all $e \in E_\Gamma$
3. $\theta_e(e) = \bar{e}$ for all $e \in E_\Gamma$

We call the pair (Γ, θ) a $(d$ -valent) graph-connection pair.

Definition 1.1.2. ([14]) A function $\alpha: E_\Gamma \rightarrow \mathbb{R}^n$ is called an axial function for the graph-connection pair (Γ, θ) if it satisfies the following axioms.

- A1. For every $p \in V_\Gamma$, the set $\{\alpha(e) \mid e \in E_p\}$ is pairwise linearly independent.
- A2. For each $e \in E_\Gamma$, we have $\alpha(e) = -\alpha(\bar{e})$.
- A3. For each $e \in E_\Gamma$ and each $\tilde{e} \in E_{i(e)} \setminus \{e\}$, we have

$$\alpha(\tilde{e}) - \lambda_e(\tilde{e})\alpha(\theta_e(\tilde{e})) = c_e(\tilde{e})\alpha(e),$$

for some $\lambda_e(\tilde{e}) \in \mathbb{R}_+$ and some $c_e(\tilde{e}) \in \mathbb{R}$.

Definition 1.1.3. A d -valent 1-skeleton with connection in \mathbb{R}^n is a triple denoted by $(\Gamma, \alpha, \theta) \subset \mathbb{R}^n$ consisting of a d -valent graph Γ , a connection θ on Γ and an axial function $\alpha: E_\Gamma \rightarrow \mathbb{R}^n$ for the graph-connection pair (Γ, θ) .

Remark. It is useful to think of the positive constants in A3 in Definition 1.1.2 as function values; i.e. $\lambda = \{\lambda_e\}_{e \in E_\Gamma}$ where

$$\lambda_e: E_{i(e)} \rightarrow \mathbb{R}_+,$$

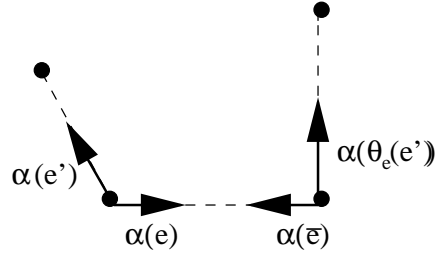

Figure 1. axial function

and as a convention we will set

$$\lambda_e(e) = 1.$$

We will refer to these function values as compatibility constants for the 1-skeleton with connection $(\Gamma, \alpha, \theta) \subset \mathbb{R}^n$. Note that A1 guarantees that λ is uniquely determined by the triple (Γ, α, θ)

Remark 1. Besides introducing the notion of 1-skeleton with connection as in Definition 1.1.3 in [14] Guillemin and Zara also introduced a more restrictive notion of a GKM 1-skeleta. A GKM 1-skeleton with connection is a 1-skeleton with connection as in Definition 1.1.3 whose compatibility constants are all equal to 1.

Definition 1.1.4. Given a graph Γ we say that a function

$$\alpha: E_\Gamma \rightarrow \mathbb{R}^n$$

is effective if the set of vectors

$$\alpha(E_p) := \{\alpha(e) \mid e \in E_p\} \subset \mathbb{R}^n$$

spans \mathbb{R}^n for each $p \in V_\Gamma$. We say that α is k -independent if for every vertex $p \in V_\Gamma$ and for any k -subset e_1, \dots, e_k of oriented edges at p , the set $\{\alpha(e_1), \dots, \alpha(e_k)\}$ is linearly independent. We will say that the 1-skeleton $(\Gamma, \alpha, \theta) \subset \mathbb{R}^n$ is k -independent if α is k -independent.

Note that every 1-skeleton $(\Gamma, \alpha, \theta) \subset \mathbb{R}^n$ is 2-independent by A1.

Remark. *In the case where the 1-skeleton with connection $(\Gamma, \alpha, \theta) \subset \mathbb{R}^n$ is 3-independent, the connection θ on Γ is uniquely determined by A3 in Definition 1.1.2. When the connection is understood or is irrelevant to the discussion, we will just write $(\Gamma, \alpha) \subset \mathbb{R}^n$ and refer to this as a d -valent 1-skeleton in \mathbb{R}^n . Similarly when the ambient vector space \mathbb{R}^n is understood from the context we will just write (Γ, α) .*

Definition 1.1.5. *A 1-skeleton $(\Gamma, \alpha) \subset \mathbb{R}^n$ has an embedding if there is a function*

$$f: V_\Gamma \rightarrow \mathbb{R}^n$$

with the property that for each $\overline{pq} \in E_\Gamma$ there is a positive constant $c_{\overline{pq}} \in \mathbb{R}_+$ such that

$$f(q) - f(p) = c_{\overline{pq}} \alpha(\overline{pq}).$$

Most of the 1-skeleta that we will encounter here will have embeddings. If a 1-skeleton $(\Gamma, \alpha) \subset \mathbb{R}^n$ has an embedding $f: V_\Gamma \rightarrow \mathbb{R}^n$, then we can “realize” (Γ, α) in the sense that V_Γ is identified with the subset $\{f(p) \mid p \in V_\Gamma\} \subset \mathbb{R}^n$ and the oriented edges $\overline{pq} \in E_\Gamma$ are identified with the oriented straight line segments joining $f(p)$ to $f(q)$. Also note that if (Γ, α) has an embedding then there is another axial function $\tilde{\alpha}$ on Γ defined by

$$\tilde{\alpha}(\overline{pq}) = f(q) - f(p).$$

1.2 Examples

We take this opportunity to look at some examples so that the reader can get some idea of the type of objects we are dealing with here. There are two well known sources of examples for 1-skeleta (by this we mean that these examples show up under different guises

elsewhere in mathematics). These are simple polytopes and finite reflection groups. Both of these sources serve as prototypical examples for the general theory of 1-skeleta in the sense that many of the definitions and notions we have regarding 1-skeleta are motivated by phenomena occurring in these special cases. We give a treatment of 1-skeleta coming from simple polytopes in Chapter 2, and those arising from finite reflection groups will be dealt with towards the end of Chapter 4. Of course there are many more types of 1-skeleta as we shall see. This section is intended to be a brief, casual guided tour through a gallery of examples. Many of these examples will be expounded upon in later chapters.

Unless otherwise indicated, all of the figures are assumed to have embeddings and to be realized in the sense described above; the vertices of the graph are indicated by dots, the edges of the graph are indicated by straight line segments joining two dots and the value of the axial function at an oriented edge is always assumed to be lying in the direction of line segment representing the edge and pointing toward the terminal vertex of the oriented edge. In some cases when there is no embedding or when we want to emphasize a particular axial function, we will indicate on the graph with arrows the values of the axial function at the different edges.

The 1-skeleton in Figure 2 is the 1-skeleton of a polygon in \mathbb{R}^2 . We will see in Chapter 2 that in general, any simple d -polytope in \mathbb{R}^d gives a d -valent 1-skeleton in \mathbb{R}^d .

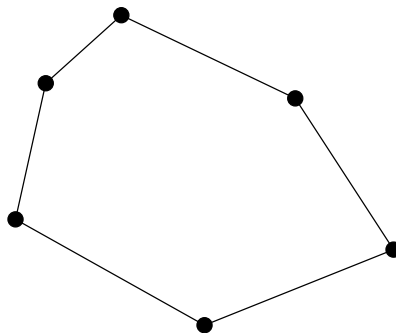

Figure 2. a polygon

In fact the axioms in Definition 1.1.2 are flexible enough to also allow for certain projections of 1-skeleta. In Figure 3 we have a 1-skeleton in \mathbb{R}^3 that is a projection of a deformed hyper-cube in \mathbb{R}^4 . We will have more to say about 1-skeleta of projected simple polytopes in Chapter 2 as well.

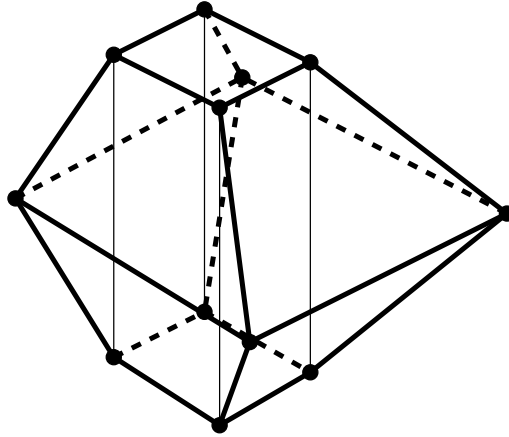

Figure 3. projected simple polytope

In some special cases certain other polytopes give rise to 1-skeleta. For instance in Figure 4 we see the 1-skeleton of what appears to be a 3-dimensional octahedron. In order to satisfy A3 in Definition 1.1.2 it is necessary that the four vertices in the “equatorial belt” lie in the same 2-plane. Hence the vertices of the octahedron must be in special position.

Moving away from polytopes we look at some other planar 1-skeleta. For instance in Figure 5 we see a 3-valent 1-skeleton in \mathbb{R}^2 whose underlying graph Γ is actually planar (when we speak of a planar *1-skeleton* we mean a 1-skeleton in \mathbb{R}^2 , whereas a planar *graph* is a graph that can be embedded in the plane in the topological sense). Those readers who are familiar with Steinitz’ theorem (see the concluding remarks in chapter 2) will note right away that this is not the 1-skeleton of a projected simple polytope.

The 1-skeleton in Figure 6 is part of a larger family of 1-skeleta arising from finite reflection groups; this one comes from the symmetric group S_3 . The finite reflection

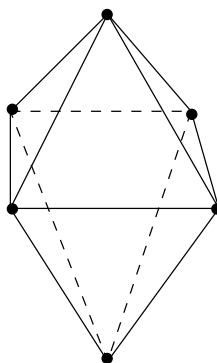

Figure 4. octahedron in special position

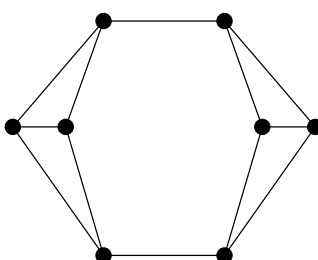

Figure 5. 3-valent planar 1-skeleton

group (S_3 in this case) acts on the 1-skeleton via reflection through the edges. We will discuss this class of 1-skeleta in more detail in Chapter 4.

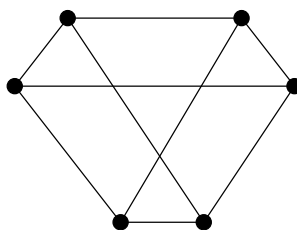

Figure 6. 1-skeleton of finite reflection group S_3

Another type of planar 1-skeleta that is related to the one shown in Figure 6 is shown in Figure 7. This 1-skeleton also comes with a finite reflection group generated by reflections through the edges. The 1-skeleton in Figure 7 is part of the larger family of *crossed-regular polygons* which we will meet formally in Chapter 3.

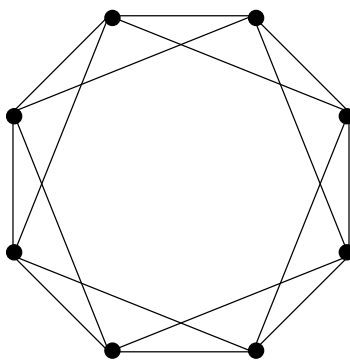

Figure 7. crossed-regular polygon

The non-convex quadrilateral shown in Figure 8 is not a 1-skeleton. More precisely, there is no axial function for this particular embedded graph. We have illustrated a possible attempt to define an axial function using axioms A2 and A3 in Definition 1.1.2: the reader can see where the attempt will fail.

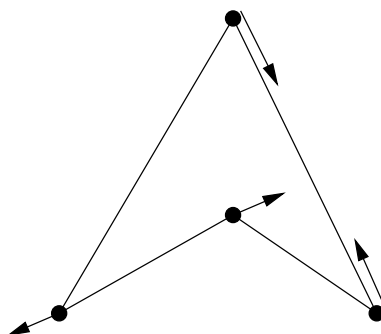

Figure 8. a non-convex polygon is not a 1-skeleton

Finally we give an illustration of the concept of an embedding. Figure 9 shows two “drawings” of the same 1-skeleton. The first drawing is an embedding while the second is not. We have indicated the axial function on each graph for emphasis.

This concludes the guided tour.

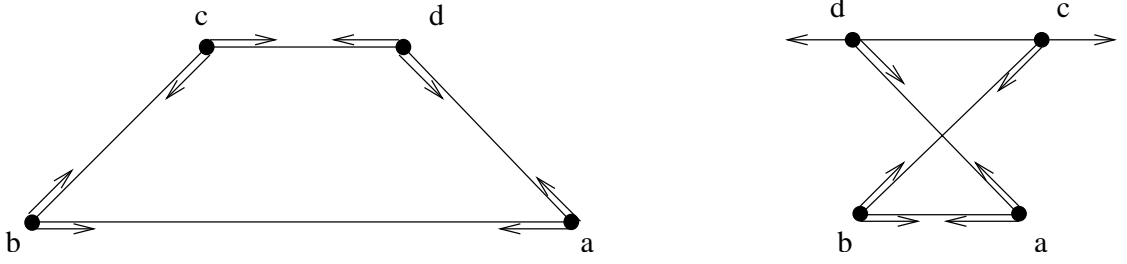

Figure 9. an embedding

1.3 Sub-skeleta, Holonomy and Straightness

Fix a d -valent 1-skeleton with connection $(\Gamma, \alpha, \theta) \subset \mathbb{R}^n$.

Let $\Gamma_0 = (V_0, E_0)$ be a connected k -valent sub-graph. We say that Γ_0 is the graph of a *sub-skeleton* of Γ if the restriction of α to E_0 ,

$$\alpha_0 := \alpha|_{E_0} : E_0 \rightarrow \mathbb{R}^n$$

is an axial function on Γ_0 ; we write $(\Gamma_0, \alpha_0) \subset (\Gamma, \alpha)$ in this case. For each $p \in V_{\Gamma_0}$ set $E_p^0 \subset E_p$ to be those edges at p that lie in Γ_0 and set $N_p^0 = E_p \setminus E_p^0$ to be the *normal edges* to Γ_0 at p . We set

$$N^0 := \bigcup_{p \in V_{\Gamma_0}} N_p^0.$$

If $\theta = \{\theta_e\}_{e \in E_{\Gamma}}$ is a connection on Γ and

$$\theta_e(E_{i(e)}^0) \subset E_{t(e)}^0$$

for each $e \in E_0$ then we can restrict θ to Γ_0 to get a connection

$$\theta_0 = \{(\theta_0)_e := (\theta_e)|_{E_{i(e)}^0}\}_{e \in E_0}$$

on Γ_0 for which α_0 is compatible. In this case Γ_0 is the graph of a *totally geodesic sub-skeleton* of Γ and we write $(\Gamma_0, \alpha_0, \theta_0) \subset (\Gamma, \alpha, \theta)$. Note in this case there are also induced maps on the normal edges $\theta_e^\perp : N_{i(e)}^0 \rightarrow N_{t(e)}^0$ for each $e \in E_0$.

(Γ, α, θ) always admits a certain class of totally geodesic sub-skeleta called k -slices that are gotten as follows. For each sub-space $H \subset \mathbb{R}^n$ we define the sub-graph $\Gamma_H = (V_H, E_H) \subset \Gamma$ by defining

$$E_H := \{e \in E_\Gamma \mid \alpha(e) \in H\}$$

and

$$V_H := \{v \in V_\Gamma \mid v = i(e) \text{ for some } e \in E_H\}.$$

We will denote by $\Gamma_H^0 = (V_H^0, E_H^0) \subset \Gamma_H \subset \Gamma$ any connected component of Γ_H .

Theorem 1.3.1. *The sub-graph Γ_H^0 has constant valency and is the graph of a totally geodesic sub-skeleton $(\Gamma_H^0, \alpha_H^0, \theta_H^0)$ of (Γ, α, θ) .*

Proof. Fix $e := \overline{pq} \in E_H^0$. We need to show that $\theta_e((E_H^0)_p) = (E_H^0)_q$. Let $e' \in (E_H^0)_p$ be any oriented edge at p different from e . Then $\alpha(\theta_e(e'))$ must lie in the 2-plane $\text{span}_{\mathbb{R}}\{\alpha(e), \alpha(e')\}$ by A3 in Definition 1.1.2. Since $\alpha(e)$ and $\alpha(e')$ both lie in the sub-space H , $\alpha(\theta_e(e'))$ must also lie in H . Conversely let $e' \in E_p \setminus (E_H^0)_p$ be any oriented edge at p not in Γ_H^0 . Then the 2-plane $\text{span}_{\mathbb{R}}\{\alpha(e), \alpha(e')\}$ intersects H in the line spanned by $\alpha(e)$. If $\alpha(\theta_e(e'))$ lies in H then it must be collinear with $\alpha(e)$. This means that $\alpha(\theta_e(e'))$ and $\alpha(\bar{e})$ must be collinear by A2 in Definition 1.1.2. On the other hand this is impossible by A1 in Definition 1.1.2. Therefore $\alpha(\theta_e(e'))$ does not lie in H . \square

If $\dim(H) = k$ we call $(\Gamma_H^0, \alpha_H^0, \theta_H^0)$ a k -slice of (Γ, α, θ) . Of particular interest to us in subsequent chapters will be the 2-slices of a 1-skeleton.

Fix a totally geodesic sub-skeleton $(\Gamma_0, \alpha_0, \theta_0)$. Fix vertices $p, q \in V_\Gamma$. Let

$$\gamma: p_0 = p \rightarrow \dots \rightarrow q = p_j$$

be a path from p to q .

Definition 1.3.2. *The path-connection map for γ is*

$$K_\gamma := \theta_{p_{j-1}p_j} \circ \dots \circ \theta_{p_0p_1} : E_{p_0} \rightarrow E_{p_j}.$$

If $\gamma \in \Gamma_0$ the normal path-connection map for γ is

$$K_\gamma^\perp := \theta_{p_{j-1}p_j}^\perp \circ \dots \circ \theta_{p_0p_1}^\perp : N_{p_0}^0 \rightarrow N_{p_j}^0.$$

A *loop* in Γ is a path γ from a vertex p to itself:

$$\gamma : p \rightarrow \dots \rightarrow p.$$

Definition 1.3.3. *The path-connection map (resp. normal path-connection map) $K_\gamma : E_p \rightarrow E_p$ (resp. $K_\gamma^\perp : N_p^0 \rightarrow N_p^0$) for a loop $\gamma : p \rightarrow \dots \rightarrow p$ is called the holonomy map (resp. normal holonomy map) for γ .*

Note that holonomy maps (resp. normal holonomy maps) act as permutations of the finite sets E_p (resp. N_p^0). If the permutation is the identity, we say that the holonomy map (resp. normal holonomy map) is trivial.

Definition 1.3.4. *A totally geodesic sub-skeleton $(\Gamma_0, \alpha_0, \theta_0)$ has trivial normal holonomy if all of the normal holonomy maps K_γ^\perp are trivial.*

The compatibility constants record important information about the 1-skeleton with connection (Γ, α, θ) . The path-connection maps transport edges to edges along paths and hence give combinatorial information about the structure of the pair (Γ, θ) . By examining how the compatibility constants transport along a path we get geometric information about the 1-skeleton (Γ, α, θ) . This leads to a notion of straightness which will play an important role in what follows.

Let $\{\lambda_e\}_{e \in E_\Gamma}$ be compatibility constants on (Γ, α, θ) .

Definition 1.3.5. *The path-connection number for γ is*

$$|K_\gamma| := \left(\prod_{e \in E_{p_0}} \lambda_{\overline{p_0 p_1}}(e) \right) \cdots \left(\prod_{e \in E_{p_{j-1}}} \lambda_{\overline{p_{j-1} p_j}}(e) \right).$$

If $\gamma \subset \Gamma_0$ the normal path-connection number for γ is

$$|K_\gamma^\perp| := \left(\prod_{e \in N_{p_0}^0} \lambda_{\overline{p_0 p_1}}(e) \right) \cdots \left(\prod_{e \in N_{p_{j-1}}^0} \lambda_{\overline{p_{j-1} p_j}}(e) \right).$$

For each $e \in E_p$ the path-connection number for γ at e is

$$|K_\gamma(e)| := \prod_{i=1}^j \lambda_{\overline{p_{i-1} p_i}}(\theta_{\overline{p_{i-2} p_{i-1}}} \circ \cdots \circ \theta_{\overline{p_0 p_1}}(e)).$$

If γ is a loop, replace the term “path-connection” with “holonomy”.

Definition 1.3.6. *Let (Γ, α, θ) be a 1-skeleton and $(\Gamma_0, \alpha_0, \theta_0)$ a totally geodesic sub-skeleton.*

- A. *The 1-skeleton (Γ, α, θ) is straight if $|K_\gamma| = 1$ for every loop γ in Γ .*
- B. *The totally geodesic sub-skeleton $(\Gamma_0, \alpha_0, \theta_0)$ is normally straight in (Γ, α, θ) if $|K_\gamma^\perp| = 1$ for every loop γ in Γ_0 .*
- C. *$(\Gamma_0, \alpha_0, \theta_0)$ is level in (Γ, α, θ) if for each $e \in N_p^0$ and every loop γ in Γ_0 such that $K_\gamma(e) = e$, we have $|K_\gamma(e)| = 1$.*

As we will see in Chapter 3, level implies normally straight. However the converse does not hold in general. For example consider the 4-valent 1-skeleton $(\Gamma, \alpha) \subset \mathbb{R}^2$ shown in Figure 10. Choose a connection $\theta = \{\theta_e\}_{e \in E_\Gamma}$ on (Γ, α) such that the induced subgraph Γ_0 on the vertex set $\{p, q, r\}$ is totally geodesic and around the edges of Γ_0 , satisfies

$$\begin{aligned} \theta_{\overline{pq}}(\overline{pp_i}) &= \overline{qq_{1-i}}, \\ \theta_{\overline{pr}}(\overline{pp_i}) &= \overline{rr_{1-i}}, \\ \theta_{\overline{qr}}(\overline{qq_i}) &= \overline{rr_i}, \end{aligned}$$

for $i = 0, 1$.

Equipped with this connection the sub-skeleton $(\Gamma_0, \alpha_0, \theta_0)$ has trivial normal holonomy (i.e. $\theta_{\overline{r\overline{p}}} \circ \theta_{\overline{q\overline{r}}} \circ \theta_{\overline{p\overline{q}}}(\overline{pp_i}) = \overline{pp_i}$, for $i = 0, 1$) and is normally straight. However $(\Gamma_0, \alpha_0, \theta_0)$ is not level in this case (the compatibility constants $\lambda_{\overline{p\overline{q}}}$ and $\lambda_{\overline{r\overline{p}}}$ are identically 1, whereas $\lambda_{\overline{q\overline{r}}}$ is not).

Normal straightness is a property of totally geodesic sub-skeleta that is insensitive to the normal connection, whereas levelness is a more sensitive property that detects changes in the normal holonomy. In this last example it is possible to choose a different connection on (Γ, α) such that Γ_0 is totally geodesic and level.

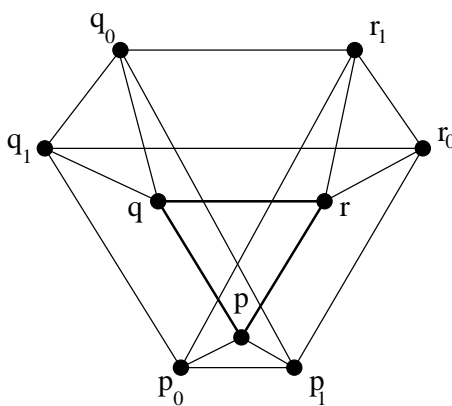

Figure 10. normally straight, but not level

The following computation will be used throughout this thesis. We state it as a lemma so we can refer to it later.

Let $H \subset \mathbb{R}^n$ k -dimensional sub-space and let $(\Gamma_H^0, \alpha_H^0, \theta_H^0)$ be a k -slice. Fix $p \in V^0$. Fix an oriented edge $e \in E_p^0$ and an oriented edge $e' \in N_p^0$. Let $W \subset \mathbb{R}^n$ denote the $k + 1$ -dimensional subspace spanned by H and $\alpha(e')$ (note that $\alpha(e')$ does not lie in H) and let $\eta_{e'} \in (W)^*$ denote the covector that annihilates H .

Lemma 1.3.7. *The compatibility constant $\lambda_e(e')$ satisfies the equation*

$$\lambda_e(e') = \frac{\langle \eta_{e'}, \alpha(e') \rangle}{\langle \eta_{e'}, \alpha(\theta_e(e')) \rangle}. \quad (1.3.1)$$

Proof. First observe that the constant $\lambda_e(e')$ is uniquely determined by the condition $\alpha(e') - \lambda_e(e')\alpha(\theta_e(e')) \in \text{span}_{\mathbb{R}}\{\alpha(e)\}$. Therefore it suffices to check that

$$\alpha(e') - \frac{\langle \eta_{e'}, \alpha(e') \rangle}{\langle \eta_{e'}, \alpha(\theta_e(e')) \rangle} \alpha(\theta_e(e')) \in \text{span}_{\mathbb{R}}\{\alpha(e)\}. \quad (1.3.2)$$

The LHS of (1.3.2) is in the 2-plane spanned by $\alpha(e)$ and $\alpha(e')$ (since $\alpha(\theta_e(e'))$ is) and the LHS is also in the k -plane H (since H is the subspace of W characterized by the vanishing of η_e). But these two sub-spaces meet only in the one dimensional linear subspace $\text{span}_{\mathbb{R}}\{\alpha(e)\}$ hence equation (1.3.2) must hold and this proves the lemma. \square

Lemma 1.3.7 implies that the k -slices of a 1-skeleton are always level.

Corollary 1.3.8. *Every k -slice is level.*

Proof. Let $\gamma: p_0 \rightarrow p_1 \rightarrow \cdots \rightarrow p_{r-1} \rightarrow p_0$ be a loop in Γ_H^0 . Then

$$|K_\gamma(e')| = \prod_{i=0}^{r-1} \lambda_{\overline{p_i p_{i+1}}}(\theta_{\overline{p_{i-1} p_i}} \circ \cdots \circ \theta_{\overline{p_0 p_1}}(e')) = \frac{\langle \eta_{e'}^0, \alpha(e') \rangle}{\langle \eta_{e'}^0, \alpha(K_\gamma(e')) \rangle}.$$

In particular if $K_\gamma(e') = e'$, then $|K_\gamma(e')| = 1$. This shows that the k -slice $(\Gamma^0, \alpha^0, \theta^0)$ is level. \square

1.4 Polarizations

Fix a d -valent 1-skeleton with connection $(\Gamma, \alpha, \theta) \subset \mathbb{R}^n$.

An *orientation* of Γ is a choice of one oriented edge for each pair $\{e, \bar{e}\} \subset E_\Gamma$; this chosen oriented edge is called the *directed edge*. A path

$$\gamma: p \rightarrow \cdots \rightarrow q$$

is said to be *oriented* (with respect to the orientation on Γ) if $\overline{p_i p_{i+1}}$ is a directed edge.

The orientation is called *acyclic* if there are no oriented loops.

A covector $\xi \in (\mathbb{R}^n)^*$ is *generic* with respect to the pair (Γ, α) if $\langle \xi, \alpha(e) \rangle \neq 0$ for each edge $e \in E_\Gamma$ where $\langle \xi, x \rangle$ denotes the dual pairing of $\xi \in (\mathbb{R}^n)^*$ with $x \in \mathbb{R}^n$. A generic covector ξ for Γ induces an orientation on Γ by declaring $e \in E_\Gamma$ to be a directed edge if and only if $\langle \xi, \alpha(e) \rangle > 0$.

Definition 1.4.1. *The generic covector ξ is called polarizing if the induced orientation on Γ is acyclic. If there is a polarizing covector ξ for the pair (Γ, α) then we say that the 1-skeleton $(\Gamma, \alpha) \subset \mathbb{R}^n$ admits a polarization or that $(\Gamma, \alpha) \subset \mathbb{R}^n$ is polarized by ξ .*

Remark. *In [14], Guillemin and Zara use the term “polarizing” to describe what we call “generic” and what we call a “polarizing covector” they call a “polarizing covector satisfying the ‘no-cycle condition’”.*

A 1-skeleton need not admit any polarization at all. For example the 3-valent 1-skeleton shown in Figure 11 does not admit any polarization. In this example the axial function value at each oriented edge is assumed to lie on the line segment representing the edge and to point from the initial vertex to the terminal vertex except at the two inner edges where we have indicated the “corrected” assignment with arrows. See [14] for another example coming from geometry.

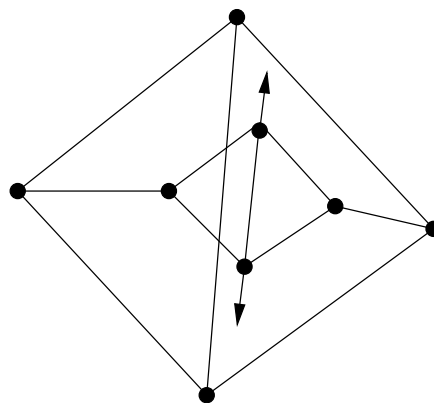

Figure 11. no polarization

On the other hand if a 1-skeleton admits an embedding, then every generic covector $\xi \in (\mathbb{R}^n)^*$ is polarizing. We state this formally as a lemma because we will appeal to this fact later. Guillemin and Zara also make this observation in [13].

Lemma 1.4.2. *If $(\Gamma, \alpha) \subset \mathbb{R}^n$ has an embedding then every generic covector ξ for (Γ, α) is polarizing.*

Proof. Let $\xi \in (\mathbb{R}^n)^*$ be a generic covector for $(\Gamma, \alpha) \subset \mathbb{R}^n$ and let $f: V_\Gamma \rightarrow \mathbb{R}^n$ be an embedding for (Γ, α) . Suppose that

$$\gamma: p_0 \rightarrow \cdots \rightarrow p_n \rightarrow p_0$$

is an oriented loop with respect to the orientation induced by ξ . Then we have

$$0 < \langle \xi, \alpha(\overline{p_i p_{i+1}}) \rangle$$

for $0 \leq i \leq n$. Since f is an embedding we get the string of inequalities

$$\langle \xi, f(p_0) \rangle < \langle \xi, f(p_1) \rangle < \cdots < \langle \xi, f(p_n) \rangle < \langle \xi, f(p_0) \rangle,$$

which is a contradiction. Hence there are no oriented loops in the orientation induced by ξ hence ξ is polarizing. \square

Definition 1.4.3. ([14]) *Given a polarizing vector $\xi \in (\mathbb{R}^n)^*$ for (Γ, α) we say an injective function $\phi: V_\Gamma \rightarrow \mathbb{R}$ is a Morse function on (Γ, α) compatible with ξ if for each edge $\overline{pq} \in E_\Gamma$ satisfying $\langle \xi, \alpha(\overline{pq}) \rangle > 0$ we have $\phi(p) < \phi(q)$.*

Remark. *As pointed out in [14], the existence of a polarizing vector guarantees the existence of a compatible Morse function. Indeed just define $\phi(v)$ to be the length of the longest oriented path in Γ that starts at v . This is well defined since there are no oriented loops. We can then perturb ϕ a little to make it injective.*

Definition 1.4.4. ([14]) For $p \in V_\Gamma$ define the index of v (with respect to a generic covector ξ) to be the number of oriented edges “directed into” v ; in other words

$$\text{ind}_\xi(p) := \#\{e \in E_p \mid \langle \xi, \alpha(e) \rangle < 0\}.$$

Define the i^{th} combinatorial Betti number of Γ by

$$b_i(\Gamma, \alpha) := \#\{p \in V_\Gamma \mid \text{ind}_\xi(p) = i\}.$$

While the index of a vertex of Γ clearly depends on the generic covector, ξ , a theorem of Bolker implies that the combinatorial Betti numbers are actually independent of ξ .

Theorem 1.4.5. *The numbers $b_i(\Gamma, \alpha)$ are independent of the generic covector ξ .*

Proof. The set of direction vectors $\{\alpha(e) \mid e \in E_\Gamma\} \subset \mathbb{R}^n$ divide $(\mathbb{R}^n)^*$ into cones, the walls of which are the annihilators of the $\alpha(e)$ ’s. The idea is then to examine what happens to the combinatorial Betti numbers of (Γ, α) as one passes from one cone to a neighboring one. For more details, see [14], Theorem 1.3.1. \square

1.5 Cohomology Rings

In this subsection we introduce two (related) rings associated to a 1-skeleton that will play a central role in this thesis (in particular Chapters 3 and 4).

Fix a d -valent 1-skeleton with connection $(\Gamma, \alpha, \theta) \subset \mathbb{R}^n$. Let $S := \text{Sym}(\mathbb{R}^n)$ denote the symmetric algebra of \mathbb{R}^n or, equivalently, the ring of polynomial functions on $(\mathbb{R}^n)^*$. Let

$$\text{Maps}(V_\Gamma, S) \cong \bigoplus_{p \in V_\Gamma} S.$$

$\text{Maps}(V_\Gamma, S)$ is a graded ring where multiplication is component-wise.

For any subset $I \subset S$, let $\langle I \rangle \subset S$ denote the ideal generated by I .

Definition 1.5.1. *The equivariant cohomology ring of $(\Gamma, \alpha) \subset \mathbb{R}^n$ is the subring*

$$H(\Gamma, \alpha) := \{f: V_\Gamma \rightarrow S \mid f(p) - f(q) \in \langle \alpha(\overline{pq}) \rangle \text{ for each } \overline{pq} \in E_\Gamma\}.$$

We let $H^i(\Gamma, \alpha)$ denote the i^{th} graded piece of $H(\Gamma, \alpha)$. The polynomial ring S includes in $H(\Gamma, \alpha)$ as the constant functions, giving $H(\Gamma, \alpha)$ the structure of a graded S -algebra. We will discuss sufficient conditions for $H(\Gamma, \alpha)$ to be a free S -module in chapter 3; in fact this is one of the motivating questions for the work in Chapter 3.

Let $S^+ \subset S$ denote the ideal generated by polynomials of positive degree.

Definition 1.5.2. *The (ordinary) cohomology ring is the quotient ring*

$$\overline{H(\Gamma, \alpha)} := (H(\Gamma, \alpha)/S^+ \cdot H(\Gamma, \alpha)).$$

We will often use the identity

$$\overline{H(\Gamma, \alpha)} \cong H(\Gamma, \alpha) \otimes_S S/S^+ = H(\Gamma, \alpha) \otimes_S \mathbb{R}. \quad (1.5.1)$$

We will refer to an element of the equivariant (resp. ordinary) cohomology ring of a 1-skeleton as an *equivariant class* (resp. *ordinary class*) (when it is clear from the context we may drop the prefix and just say *class*).

The *support* of an equivariant class $f \in H(\Gamma, \alpha)$ is defined to be the set of vertices of the graph Γ on which the function f is non-zero; i.e. $\text{supp}(f) := \{p \in V_\Gamma \mid f(p) \neq 0\}$.

One example of an equivariant class (in degree 1) that we have already encountered is an embedding of a 1-skeleton. See Figure 12.

We will often be interested in classes whose support is a sub-skeleton.

Definition 1.5.3. *A Thom class for a k -valent sub-skeleton $(\Gamma_0, \alpha_0) \subset (\Gamma, \alpha)$ is a non-zero homogeneous equivariant class $f \in H^{d-k}(\Gamma, \alpha)$ such that $\text{supp}(f) \subset \Gamma_0$.*

Not every sub-skeleton admits a Thom class; this is related to normal straight-ness; see Chapter 3, Proposition 3.1.7.

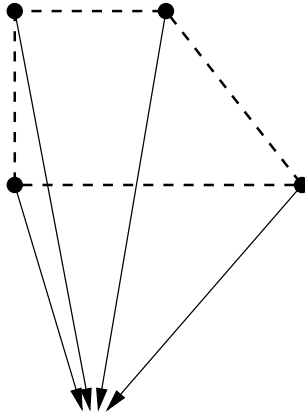

Figure 12. an embedding is an equivariant class

Another type of equivariant class we will frequently consider are certain top-degree classes.

Definition 1.5.4. A top class for (Γ, α) is any non-zero homogeneous equivariant class $\tau \in H^d(\Gamma, \alpha)$ such that $\text{supp}(\tau) \subset \{p\}$ for some vertex $p \in V_\Gamma$.

Note that top classes always exist. However they do not always survive in passing to ordinary cohomology; this is related to the straight-ness of the 1-skeleton; see Chapter 3, Proposition 3.1.10.

1.6 Morphisms

Let $(\Gamma, \theta, \alpha) \subset \mathbb{R}^m$ and $(\Gamma', \theta', \alpha') \subset \mathbb{R}^n$ be two 1-skeleta with connections.

Definition 1.6.1. A morphism of graphs $\pi_G : \Gamma \rightarrow \Gamma'$ is a map of sets

$$\pi_G : V_\Gamma \sqcup E_\Gamma \rightarrow V_{\Gamma'} \sqcup E_{\Gamma'}$$

such that

G1. $\pi_G(V_\Gamma) \subset V_{\Gamma'}$ and

G2.

$$\pi_G(\overline{pq}) = \begin{cases} \overline{\pi(p)\pi(q)} & \text{if } \pi(p) \neq \pi(q) \\ \pi(p) & \text{if } \pi(p) = \pi(q) \end{cases} \quad (1.6.1)$$

We say that $\pi_G: (\Gamma, \theta) \rightarrow (\Gamma', \theta')$ is a morphism of graph-connection pairs if in addition to G1 and G2 we also have

G3. for each $e, \tilde{e} \in \pi_G^{-1}(E_{\Gamma'}) \cap E_p$ we have that

$$\theta_e(\tilde{e}) \in \pi_G^{-1}(E_{\Gamma'})$$

and

$$\pi_G(\theta_e(\tilde{e})) = \theta'_{\pi_G(e)}(\pi_G(\tilde{e})).$$

Set

$$E^h := \pi_G^{-1}(E_{\Gamma'}) \subset E_{\Gamma};$$

we call this the set of *horizontal edges of Γ (with respect to π_G)*. Set

$$E^v := \pi_G^{-1}(V_{\Gamma'}) \cap E_{\Gamma};$$

we call this the set of *vertical edges of Γ (with respect to π_G)*. For each vertex $p \in V_{\Gamma}$ we denote by E_p^h the horizontal edges at p and E_p^v denotes the vertical edges at p . The morphism of graphs π_G restricts to give a map of edge sets

$$\pi_G: E^h \rightarrow E_{\Gamma'},$$

and for each vertex $p \in V_{\Gamma}$

$$\pi_{G,p}: E_p^h \rightarrow E'_{\pi_G(p)}.$$

Definition 1.6.2. A morphism of 1-skeleta (with connection) is a pair

$$\pi := (\pi_G, \pi_L): (\Gamma, \alpha, \theta) \rightarrow (\Gamma', \alpha', \theta')$$

where π_G is a morphism of graphs (with connection) and π_L is a linear map (in the opposite direction) that makes the diagram commute

$$\begin{array}{ccc} \mathbb{R}^m & \xleftarrow{\pi_L} & \mathbb{R}^n \\ \alpha \uparrow & & \uparrow \alpha' \\ \pi_G^{-1}(E_{\Gamma'}) & \xrightarrow{\pi_G} & E_{\Gamma'} \end{array}$$

We refer to π_G as the graph component of π and to π_L as the linear component of π .

Remark. A morphism of 1-skeleta (with connection) as in Definition 4.2.1 induces a map of rings on the equivariant cohomology rings in the opposite direction:

$$\pi^* : H(\Gamma', \alpha') \rightarrow H(\Gamma, \alpha)$$

$$f \mapsto \hat{\pi}_L \circ f \circ \pi_G$$

where $\hat{\pi}_L : S(\mathbb{R}^n) \rightarrow S(\mathbb{R}^m)$ is the map of polynomial rings induced by π_L . Note that constant functions map to constant functions under π^* (although not identically in general), hence π^* passes to a map on ordinary cohomology

$$\overline{\pi^*} : \overline{H(\Gamma', \alpha')} \rightarrow \overline{H(\Gamma, \alpha)}.$$

Given a totally geodesic sub-skeleton $(\Gamma_0, \alpha_0, \theta_0) \subset (\Gamma, \alpha, \theta) \subset \mathbb{R}^n$ there is always an inclusion morphism,

$$i := (i_G, I_{\mathbb{R}^n}) : (\Gamma_0, \alpha_0, \theta_0) \rightarrow (\Gamma, \alpha, \theta)$$

where i_G is the inclusion of graphs and $I_{\mathbb{R}^n}$ is the identity map on \mathbb{R}^n . The induced morphism $i^* : H(\Gamma, \alpha) \rightarrow H(\Gamma_0, \alpha_0)$ is the restriction of functions to the subgraph Γ_0 . Although in many important cases this restriction map will be surjective, it is easy to find examples where it is not.

For example the 1-skeleton shown in Figure 13 has two ‘‘combinatorially equivalent’’ factors. However the one on the right has been twisted in the middle. One can show

directly that while the factor on the left supports a Thom class on its upper triangle, the factor on the right does not. Hence it is impossible to extend this Thom class on the right factor to a global class on the entire 1-skeleton. We have illustrated in the figure an attempt to extend such a class; the arrows and 0's are the desired values of the class at the vertices and the question marks indicate where we get stuck. The 1-skeleton in Figure 13 is an example of a pseudo-fiber bundle of 1-skeleta (see Chapter 4, Definition 4.2.5).

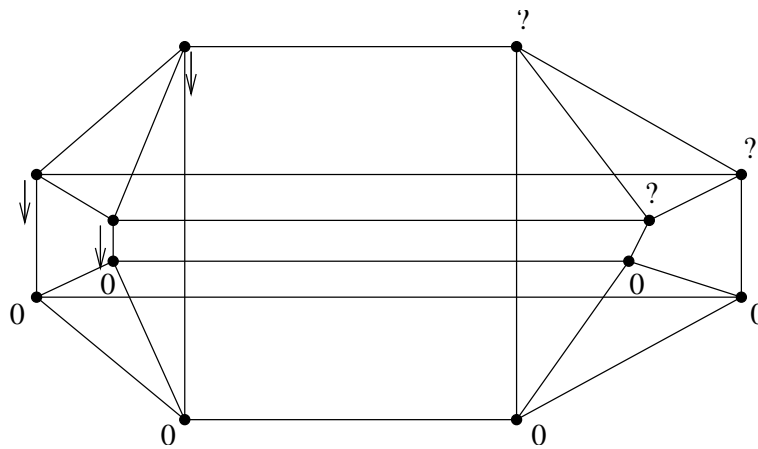

Figure 13. restriction to the left factor is not surjective

1.7 1-skeleta in Nature

In this section we define a class of smooth manifolds admitting compact torus actions called GKM T -manifolds. We then show how one obtains a 1-skeleton from a GKM T -manifold.

Let M be a $2d$ -dimensional compact smooth manifold. A 2-form on M is a smooth section

$$\omega: M \rightarrow \wedge^2 T^*M,$$

or equivalently a family of alternating, \mathbb{R} -bilinear forms

$$\omega_p: T_p M \times T_p M \rightarrow \mathbb{R}$$

varying smoothly with $p \in M$.

A metric g on M is a smooth positive definite section

$$g: M \rightarrow S^2(T^* M),$$

or equivalently a family of symmetric, positive definite \mathbb{R} -bilinear forms

$$g_p: T_p M \times T_p M \rightarrow \mathbb{R}$$

varying smoothly with $p \in M$.

Let $T = (S^1)^n$ be a compact n -dimensional torus acting smoothly on M . Let $\psi_t: M \rightarrow M$ denote the diffeomorphism corresponding to $t \in T$. Suppose the T action is effective (i.e. $T \ni t \mapsto \psi_t \in \text{Diff}(M)$ is an injective group homomorphism).

We say that a smoothly varying \mathbb{R} -bilinear form $\Theta: T_p M \times T_p M \rightarrow \mathbb{R}$ is T -invariant if

$$\Theta_{\psi_t(p)}((\psi_t)_* X, (\psi_t)_* Y) = \Theta_p(X, Y)$$

for every $p \in M$ and every $X, Y \in T_p M$.

A fundamental fact from differential geometry states that every manifold M admits a metric g . We also have the following fact.

Theorem 1.7.1. *Let T be a compact Lie group acting smoothly on a manifold M . Then there is a metric g on M that is T -invariant.*

Proof. Since T is compact, we can average any fixed metric g over T to get a new metric that is T -invariant. See [19] Theorem 2.39 for the details. \square

Fix a T -invariant metric g on M . Assume that M admits a non-degenerate T -invariant 2-form ω .

Definition 1.7.2. An almost complex structure on M is a smooth section $J: M \rightarrow \text{Aut}(TM)$ such that $J^2 = -I$.

A. We say that J is compatible with ω if

$$(a) \quad \omega_p(X, J_p(X)) \geq 0 \text{ for each } p \in M \text{ and for all non-zero vectors } X \in T_p(M)$$

$$(b) \quad \omega_p(J_p(X), J_p(Y)) = \omega_p(X, Y) \text{ for each } p \in M \text{ and for all vectors } X, Y \in T_p(M).$$

B. We say that J is compatible with the metric g if

$$g_p(J_p(X), J_p(Y)) = g_p(X, Y)$$

for each $p \in M$ and for all vectors $X, Y \in T_p(M)$.

C. We say that J is T -invariant if $J_{\psi_t(p)}((\psi_t)_*X) = (\psi_t)_*(J_p(X))$ for all $p \in M$ and $X \in T_pM$.

Lemma 1.7.3. M admits a T -invariant almost complex structure J that is compatible with ω and g .

Proof. See [21] Proposition 2.61. □

Let us fix a T -invariant almost complex structure J on M that is compatible with ω and g as in Lemma 1.7.3.

Let M^T denote the T -fixed point set of M and let $p \in M^T$. There is a linear action of T on T_pM by

$$(\psi_t)_*: T_pM \rightarrow T_pM.$$

Using J we can view T_pM as a vector space over \mathbb{C} by the formula

$$(x + iy)U := xU + yJ(U).$$

Since J is T -invariant the linear action of T on T_pM respects this structure. Therefore we get a *complex* representation

$$T \ni t \xrightarrow{\rho_p} \{(\psi_t)_{*,p} : T_pM \rightarrow T_pM\} \in GL(T_pM, \mathbb{C}),$$

which is called the (*complex*) *isotropy representation* of T at p .

Now, since $\rho_p(T) \subset GL(T_pM, \mathbb{C})$ is an abelian group of matrices over \mathbb{C} , there is an $x \in GL(T_pM, \mathbb{C})$ that simultaneously diagonalizes $\rho_p(T)$. Therefore we get a decomposition of T_pM into a direct sum of simultaneous eigenspaces (called *weight spaces*)

$$T_pM \simeq \bigoplus_{i=1}^d V_i^p.$$

The function

$$\chi_i^p : T \rightarrow \mathbb{C}^*$$

that assigns to each group element its eigenvalue for the weight space V_i^p is a Lie group homomorphism called a *group character* of T . Since T is compact, this map factors through the inclusion $S^1 \hookrightarrow \mathbb{C}^*$. From Lie theory we know that there is an associated map of Lie algebras $\alpha_i^p : \mathfrak{t} \rightarrow \mathbb{R}$ that makes the following diagram commute

$$\begin{array}{ccc} T & \xrightarrow{\chi_i^p} & S^1 \subset \mathbb{C}^* \\ \exp \uparrow & & \uparrow \exp(i-) \\ \mathfrak{t} & \xrightarrow{\alpha_i^p} & \mathbb{R} \subset \mathbb{C} \end{array} .$$

The map α_i^p is to be regarded as a covector in \mathfrak{t}^* which is called the *weight* corresponding to the weight space V_i^p .

Definition 1.7.4. We say that the manifold M is a GKM T -manifold if

GKM1. the T -fixed point set M^T is finite and

GKM2. the weights $\{\alpha_i^p \mid 1 \leq i \leq d\}$ of the isotropy representation of T at p are pairwise linearly independent for each $p \in M^T$.

Suppose M is a GKM T -manifold. For each $p \in M^T$ and each character χ_i^p let $\ker(\chi_i^p) =: K_i^p \subset T$; K_i^p is a codimension one compact subgroup of T . Now restrict the T action on M to K_i^p and let $X_i^p \subset M$ denote the connected component of the fixed point set $M^{K_i^p} \subset M$ containing p . We have the following general theorems from the theory of transformation groups. We refer the reader to Kawakubo's book [19] for the proofs.

Theorem 1.7.5. *For each $x \in X_i^p$ there exists a K_i^p -invariant open neighborhood $U \subset M$ of x and a K_i^p -equivariant diffeomorphism*

$$\phi: T_x M \rightarrow U$$

(with respect to the isotropy representation of K_i^p at x).

Proof. See [19] Theorem 4.8. □

Armed with Theorem 1.7.5 one can also prove

Theorem 1.7.6. *Let K be a compact Lie group acting smoothly on a manifold M , and let $X^K \subset M$ be the fixed point set of M . Then X^K is a closed embedded sub-manifold of M .*

Proof. See [19] Theorem 4.14. □

Hence by Theorem 1.7.6 $X_i^p \subset M$ is a closed (hence compact since M is compact) embedded sub-manifold of M . By Theorem 1.7.5 the tangent space $T_p(X_i^p) \subset T_p M$ at $p \in X_i^p$ is exactly the sub-space that is fixed point-wise by the (linear) action of K_i^p . By GKM 2 we conclude that $T_p X_i^p$ is precisely the weight space V_i^p . In particular we see that X_i^p is a compact, connected sub-manifold of (real) dimension 2.

Furthermore, since the complex structure J is compatible with ω we get that $\omega|_{X_i^p}$ is non-degenerate. Hence X_i^p is orientable. Since K_i^p is the sub-group that fixes X_i^p pointwise there is an effective action of the quotient group $T/K_i^p \cong S^1$ on X_i^p . Fortunately effective S^1 actions on compact connected surfaces are completely understood.

Theorem 1.7.7. *If X is a compact, connected, orientable surface with an effective S^1 action with fixed points, then X is S^1 -equivariantly diffeomorphic to S^2 with the standard S^1 action.*

Proof. See [1] Section 3.1. □

Therefore X_i^p is an embedded T -invariant S^2 with exactly two fixed points $p, q \in M^T$.

We are now in a position to show how to associate a d -valent 1-skeleton in $\mathfrak{t}^* \cong \mathbb{R}^n$ to the $2d$ -dimensional GKM T -manifold M .

Define a graph $\Gamma = (V_\Gamma, E_\Gamma)$ where $V_\Gamma := M^T$ and E_Γ is the set of (oriented) embedded T -invariant S^2 's described above. This graph is $\frac{1}{2} \dim(M) = d$ -valent from our discussion above.

There is a natural function $\alpha: E_\Gamma \rightarrow \mathfrak{t}^*$ defined by

$$E_\Gamma \ni X_i^p \xrightarrow{\alpha} \alpha_i^p \in \mathfrak{t}^*.$$

Now we need to show that this is an axial function on Γ .

By GKM2 in Definition 1.7.4, A1 from Definition 1.1.2 holds. It follows from Theorem 1.7.7 that A2 holds for α . To see that A3 holds requires a little more effort.

Let us first cook up a connection on Γ . Fix $p, q \in M^T$ and suppose $X \subset M$ is the T -invariant S^2 containing p and q . Let $\alpha(\overline{pq}) \in \mathfrak{t}^*$ denote the weight for X and let $H \subset T$ denote the codimension 1 sub-torus whose Lie algebra is $\ker(\alpha(\overline{pq})) \subset \mathfrak{t}$. Let TM denote the tangent bundle of M , $TM|_X$ the tangent bundle of M restricted to X and ν_X the normal bundle to $X \subset M$. We have the following result, the proof of which is due to Klyachko and can be found in [20].

Proposition 1.7.8. *The normal bundle splits T -equivariantly into a direct sum of line bundles*

$$\nu_X \cong \bigoplus_{i=1}^{d-1} L_i^X.$$

Proof. Essentially Klyachko shows that ν_X decomposes in the usual sense if and only if it decomposes T -equivariantly. See [20] Theorem 1.2.3 and Proposition 1.2.5. The fact that ν_X decomposes into a direct sum of line bundles (in the usual sense) follows from a more general theorem of Grothendieck that any (holomorphic) complex vector bundle over a projective line splits. See [25] Theorem 2.1.1. That any smooth complex vector bundle over S^2 has a holomorphic structure follows from the classification of complex vector bundles. See the discussion in [4] starting on page 297, and the discussion in [25] starting on page 111. \square

This T equivariant splitting gives rise to natural maps

$$\theta_{\overline{pq}}: E_p \rightarrow E_q$$

by defining $\theta_{\overline{pq}}(Y) = Y'$ where if Y is the T -invariant S^2 containing p whose tangent space at p is $(L_i^X)_p$, then Y' is the T -invariant S^2 containing q whose tangent space at q is $(L_i^X)_q$. This defines a connection on Γ .

Finally, to see that A3 holds it suffices to see that $(\nu_X)_p$ is H -equivariantly isomorphic to $(\nu_X)_q$. Indeed if $\Upsilon_{pq}: (\nu_X)_p \rightarrow (\nu_X)_q$ is an H equivariant isomorphism and Y is a generator of weight space at p corresponding to weight α_i^p then we have

$$\Upsilon_{pq}((\psi_t)_{*,p}Y) = \chi_i^p(t) \cdot \Upsilon(Y) = \chi_i^q(t)\Upsilon(Y) = (\psi_t)_{*,q}\Upsilon_{pq}(Y).$$

Hence we see that $\chi_i^p|_H = \chi_i^q|_H$ or equivalently that

$$(\alpha_i^p - \alpha_i^q)|_{\ker(\alpha(\overline{pq}))} = 0$$

which is precisely the content of A3 in Definition 1.1.2.

The following corollary of Proposition 1.7.8 answers this call.

Corollary 1.7.9. *Given any two points $p, q \in X$, there is a H -equivariant linear isomorphism*

$$\Upsilon_{pq}: (v_X)_p \rightarrow (v_X)_q.$$

Proof. Let $\{V_\alpha\}_{\alpha \in \Lambda}$ be an open cover of X over which the normal bundle is trivial and let $\{g_{\alpha\beta}\}_{\alpha, \beta \in \Lambda}$ be the transition functions. By Proposition 1.7.8, the maps $\{g_{\alpha\beta}\}_{\alpha, \beta \in \Lambda}$ must be H -equivariant.

Since X is connected, it suffices to prove the assertion in the case where $p \in V_\beta, q \in V_\alpha$, and $V_\alpha \cap V_\beta \neq \emptyset$. In this case we fix $z \in V_\alpha \cap V_\beta$ and simply define

$$\begin{array}{ccc} (v_X)_p & \xrightarrow{\Upsilon_{pq}} & (v_X)_q \\ (p, v) & \longrightarrow & (q, g_{\alpha\beta}(z)(v)). \end{array}$$

Then Υ_{pq} is H -equivariant since $g_{\alpha\beta}$ is. □

Thus A3 holds for α and the triple (Γ, α, θ) is a 1-skeleton with connection in the sense of Definition 1.1.2. This 1-skeleton with connection is the associated 1-skeleton with connection for the GKM T -manifold M . If a 1-skeleton with connection arises from a GKM T -manifold M we will call M an underlying manifold for the 1-skeleton. Notice that the compatibility constants for (Γ, α, θ) in this case are all equal to 1 hence the 1-skeleton with connection is GKM in the sense of Remark 1.

Remark. *The connection on Γ is not canonical. However, the normal bundle always admits a canonical H -equivariant splitting into “weight sub-bundles”. If the weights of the isotropy representation at each fixed point are 3-independent, then these weight sub-bundles are necessarily line bundles; hence in this case the splitting is canonical.*

CHAPTER 2

PROJECTIONS AND LIFTING

There is a projection operation on 1-skeleta that takes as its input a 1-skeleton in \mathbb{R}^N and produces a 1-skeleton in \mathbb{R}^n for $n < N$. One can try to go backwards by asking if a given a 1-skeleton in \mathbb{R}^n is a projection of a 1-skeleton in \mathbb{R}^N for some $N > n$. This seems to be a very difficult question to answer in general. In specializing to the case $N = d$ however, the situation becomes easier to understand.

A particularly nice class of d -valent d -independent 1-skeleta are those coming from simple d -polytopes in \mathbb{R}^d , or more generally, those coming from complete simplicial fans in $(\mathbb{R}^d)^*$. In [14], Guillemin and Zara defined the notion of a *non-cyclic* 1-skeleton for the 3-independent case. It turns out that the non-cyclic 1-skeleta in the d -independent case are exactly those coming from complete simplicial fans in $(\mathbb{R}^d)^*$. The main result of this chapter is a characterization of those 1-skeleta which are projections of d -valent, d -independent non-cyclic 1-skeleta.

One of the main tools we use is a beautiful operation called *reduction* due to Guillemin and Zara. The class of 1-skeleta on which this operation can be performed is called *reducible* (in the 3-independent case, *reducible* and *non-cyclic* coincide). For 3-independent 1-skeleta, the reduction operation takes as its input a reducible d -valent 1-skeleton in \mathbb{R}^n and its output is a $(d - 1)$ -valent 1-skeleton in \mathbb{R}^{n-1} , called a *cross-section*. For general 1-skeleta (i.e. not 3-independent) the reduction operation takes a reducible d -valent

1-skeleton in \mathbb{R}^n and produces a $(d - 1)$ -valent *generalized* 1-skeleton in \mathbb{R}^{n-1} .

A d -valent, d -independent non-cyclic 1-skeleton is reducible and any projection of it is also reducible. Moreover the cross-sections of the projection coincide with the projection of the cross-sections. We will show that the converse holds as well: If the cross-sections of a d -valent reducible 1-skeleton in \mathbb{R}^n *lift*, then the 1-skeleton itself *lifts* to a d -valent d -independent non-cyclic 1-skeleton in \mathbb{R}^d .

This chapter is divided into five sections. In Section 1 we introduce the general lifting problem and we introduce and discuss the important class of 1-skeleta coming from simple polytopes. In Section 2 we define the *reducible* 1-skeleta (with connections) and describe the *reduction* operation, introducing the notions of a pre 1-skeleton and a generalized 1-skeleton along the way. In Section 3 we introduce the important *blow-up* construction (also due to Guillemin and Zara) as well as a couple of other useful constructions. In Section 4 we put it all together in order to state and prove the main result. In Section 5 we give some concluding remarks.

2.1 Projections, Simple Polytopes, and a Lifting Problem

In this section we will define the projection operation and state the general lifting problem. We then give a somewhat lengthy discussion of the class of 1-skeleta arising from simple polytopes. Finally we will specialize our lifting problem using simple polytopes as a prototypical model.

2.1.1 Projections

Fix a 1-skeleton with connection $(\Gamma, A, \theta) \subset \mathbb{R}^N$.

Let $p: \mathbb{R}^N \rightarrow \mathbb{R}^n$ be a surjective linear map and let $\text{Gr}(k, N)$ denote the set of k -

dimensional sub-spaces of \mathbb{R}^N . Define the finite subset

$$\mathcal{H} := \{H \in \text{Gr}(2, N) \mid \Gamma_H^0 \subset \Gamma \text{ has valency } \geq 2\}.$$

The map p is *generic* for $(\Gamma, A) \subset \mathbb{R}^N$ if $\dim(\pi(H)) = 2$ for each $H \in \mathcal{H}$. In other words, the projection p is generic for (Γ, A) if p preserves the 2-slices of (Γ, A) .

Given a generic projection $p: \mathbb{R}^N \rightarrow \mathbb{R}^n$ for (Γ, A) we can define a new 1-skeleton by simply pulling back A by p ; that is $(\Gamma, p \circ A)$. The generic property of p guarantees that (A1) of Definition 1.1.2 is satisfied. The linearity of p guarantees that (A2) and (A3) of Definition 1.1.2 hold; in fact $p \circ A$ is also compatible with θ with the same compatibility constants.

Definition 2.1.1. *The 1-skeleton with connection $(\Gamma, p \circ A, \theta) \subset \mathbb{R}^n$ is called the projection of (Γ, A, θ) (with respect to the generic projection p).*

Remarks. *i. It is useful to remember the connection when projecting a 1-skeleton.*

In case $(\Gamma, A, \theta) \subset \mathbb{R}^N$ is 3-independent, the connection θ is uniquely determined by A . On the other hand for a generic projection $p: \mathbb{R}^N \rightarrow \mathbb{R}^n$, the axial function $p \circ A$ may fail to be 3-independent, hence there may be other connections on Γ for which $p \circ A$ is compatible; only one can come from the projection.

ii. Projection defines a morphism of 1-skeleta with connections

$$\pi: (\Gamma, p \circ A, \theta) \rightarrow (\Gamma, A, \theta)$$

whose graph component is the identity and whose linear component is the projection map p . The induced map on equivariant cohomology $\pi^: H(\Gamma, A) \rightarrow H(\Gamma, p \circ A)$ is surjective in many important cases.*

The general lifting problem is the following.

Problem. Under what conditions is a d -valent 1-skeleton with connection $(\Gamma, \alpha, \theta) \subset \mathbb{R}^n$ a projection of a $(-n)$ effective 1-skeleton with connection $(\Gamma, A, \theta) \subset \mathbb{R}^N$ for some projection $p: \mathbb{R}^N \rightarrow \mathbb{R}^n$?

This problem may be quite difficult to solve in this generality. By restricting the class of 1-skeleta $(\Gamma, A, \theta) \subset \mathbb{R}^N$ that we project, the problem becomes more tractable. In [14], Guillemin and Zara introduced the notion of a *non-cyclic* 1-skeleton which plays a fundamental role in what follows. Here is their definition.

Definition 2.1.2. ([14]) A 1-skeleton $(\Gamma, \alpha) \subset \mathbb{R}^n$ is called *non-cyclic* if the following conditions hold:

NC1. $(\Gamma, \alpha) \subset \mathbb{R}^n$ admits a polarization

NC2. $b_0(\Gamma_H^0, \alpha_H^0) = 1$ for every 2-slice (Γ_H^0, α_H^0) .

In Figure 14, the first 1-skeleton is non-cyclic, while the second is not.

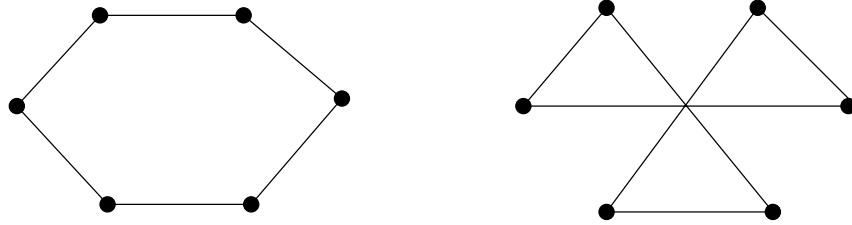

Figure 14. non-cyclic and not non-cyclic

Remarks. i. Note that if $(\Gamma, \alpha) \subset \mathbb{R}^2$ then the only 2-slice is the entire 1-skeleton so NC2 in Definition 2.2.1 reduces to saying that $b_0(\Gamma, \alpha) = 1$.

ii. In [14], Guillemin and Zara defined this notion for 3-independent 1-skeleta. We do not require this condition here. In particular we will use this notion in chapter 3 when we discuss planar 1-skeleta.

Another specialization we will make on the d -valent 1-skeleton with connection $(\Gamma, A, \theta) \subset \mathbb{R}^N$ is by restricting to the extreme case when $N = d$. Requiring A to be effective in this case is equivalent to requiring A to be d -independent. This turns out to be a very restrictive condition.

An important class of d -valent, d -independent 1-skeleta are those coming from simple polytopes.

2.1.2 Polytopes and Projected Polytopes

Here we review some basic facts about polytopes and fans. We show how to construct a 1-skeleton from a simple polytope. The main result of this section is the characterization of those 1-skeleta coming from a simplicial fan.

A d -polytope $P \subset \mathbb{R}^d$ is the convex hull of finitely many points in \mathbb{R}^d that affinely span \mathbb{R}^d (hence $P \subset \mathbb{R}^d$ is necessarily compact). A k -face of P for $0 \leq k \leq d$ is any k -dimensional subset of P that minimizes some linear functional $\eta: \mathbb{R}^d \rightarrow \mathbb{R}$ restricted to P . We call the 0-faces of P the *vertices* of P , the 1-faces of P the *edges* of P , and the $(d-1)$ -faces the *facets* of P . Note that an edge of P is a line segment joining two vertices of P so it makes sense to speak of the “oriented” edges of P .

Denote the set of vertices of P by V_P and the set of oriented edges of P by E_P . The *graph of P* is $\Gamma_P := (V_P, E_P)$. Note here that the graph Γ_P has a natural embedding in the sense of Definition 1.1.5 in chapter 1; denote this embedding by

$$V_\Gamma \longrightarrow \mathbb{R}^n$$

$$p \longrightarrow \vec{p}.$$

We say that a d -polytope $P \subset \mathbb{R}^d$ is *simple* if Γ_P is d -valent. Here are some useful facts about polytopes that we state as a theorem to be referred to hereafter. We state it without proof.

- Theorem 2.1.3.** *i. Every facet $F \subset P$ has associated to it a unique (up to positive scalar) linear functional $\eta_F: \mathbb{R}^d \rightarrow \mathbb{R}$ such that η_F is minimized on P at F . We call η_F the inner-normal covector associated to F .*
- ii. If P is simple, then for any vertex $p \in V_P$ and for any subset of k edges at p there is a unique k -face $F \subset P$ containing those edges; those edges are said to span F .*
- iii. If $P \subset \mathbb{R}^d$ is simple, then the edge directions for $(E_P)_x$ are a basis for \mathbb{R}^d for any $x \in V_P$.*

There is a natural function $\alpha_P: E_P \rightarrow \mathbb{R}^d$ defined using the embedding

$$\alpha_P(\overline{pq}) := \vec{q} - \vec{p}. \quad (2.1.1)$$

In the case $P \subset \mathbb{R}^d$ is simple we can check that α_P defines an axial function on Γ_P . Indeed, it is clear from (2.1.1) that A2 of Definition 1.1.2 holds. Item (iii) in Theorem 2.1.3 tells us that A1 holds. To see that A3 holds, let us first compute the connection $\theta_P = \{\theta_e\}_{e \in E_P}$ on Γ_P . Fix an oriented edge $e := \overline{pq} \in (E_P)_p$. For any other oriented edge $e' \in (E_P)_p$ there is a unique 2-face Q of P spanned by e, e' , by (ii) in Theorem 2.1.3. Then define $\theta_e(e') \in (E_P)_q$ to be the unique oriented edge at q that lies in Q . Then certainly we have that

$$\alpha(e') - \lambda \alpha(\theta_e(e')) = c \alpha(e) \quad (2.1.2)$$

for some $\lambda, c \in \mathbb{R}$. It follows from the convexity of Q that $\lambda > 0$, and hence $\theta_P := \{\theta_e\}_{e \in E_P}$ is a connection on Γ_P for which α_P is compatible. The 1-skeleton with connection $(\Gamma_P, \alpha_P, \theta_P) \subset \mathbb{R}^d$ is the 1-skeleton associated to the simple polytope P .

We can actually compute these compatibility constants directly. Fix $e := \overline{pq} \in (E_P)_p$ as above and let $e' \in (E_P)_p$ be any other oriented edge at p . By Theorem 2.1.3 (ii), there is a facet F containing p and e , but not containing e' . Let $\eta_F \in (\mathbb{R}^d)^*$ denote the inner-normal covector associated to F (which exists by Theorem 2.1.3 (i)). The facet

$F \subset P$ corresponds to a $(d - 1)$ -slice of $(\Gamma_P, \alpha_P, \theta_P)$. More generally any k -face $G \subset P$ corresponds to a k -slice of $(\Gamma_P, \alpha_P, \theta_P)$. Therefore by Lemma 1.3.7 in chapter 1, we have

$$\lambda_e(e') := \frac{\langle \eta_F, \alpha_P(e') \rangle}{\langle \eta_F, \alpha_P(\theta_e(e')) \rangle}. \quad (2.1.3)$$

For a simple d -polytope $P \subset \mathbb{R}^d$ the set of 2-planes \mathcal{H} that cut out the 2-slices of $(\Gamma_P, \alpha_P, \theta_P)$ are exactly the 2-planes containing the 2-faces (translated to the origin) of P . Thus a surjective linear map $p: \mathbb{R}^d \rightarrow \mathbb{R}^n$ is generic for $(\Gamma_P, \alpha_P, \theta_P)$ if and only if it preserves the 2-faces of P . The projected 1-skeleton $(\Gamma_P, p \circ \alpha_P, \theta_P) \subset \mathbb{R}^n$ is called a *projected (simple) polytope*. See Figure 15.

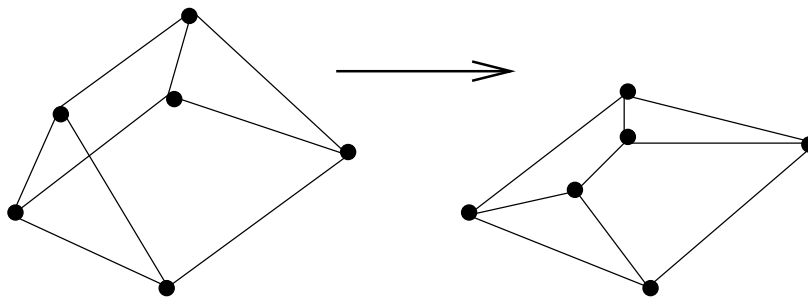

Figure 15. a simple 3-polytope and its projection

We would now like to show that d -valent d -independent non-cyclic 1-skeleta are familiar objects (in the sense that they appear (possibly under a different guise) elsewhere in mathematics). For instance if $(\Gamma, A, \theta) \subset \mathbb{R}^d$ admits an embedding, then we can show that it is the 1-skeleton associated to a simple polytope $P \subset \mathbb{R}^d$. For the general case we need to work in the larger framework of fans.

Associated to every (simple) polytope in \mathbb{R}^d is a complete (simplicial) fan in $(\mathbb{R}^d)^*$. However fans are slightly more general objects than polytopes in that a fan need not be associated to any polytope. We will review the basic notion of fans now. We follow Fulton ([9]) for the most part here.

For a set $S \subset \mathbb{R}^d$ we let $\text{conv}\{S\}$ denote the convex hull of S and let $\text{pos}\{S\}$ denote

the set of positive linear combinations of elements of S (the “positive hull”). A *convex polyhedral cone* in $(\mathbb{R}^d)^*$ is a subset of the form $\sigma = \text{pos}\{v_1, \dots, v_N\} := \{\sum_i a_i v_i \mid a_i \geq 0\}$ for some $v_i \in (\mathbb{R}^d)^*$. A *strictly convex polyhedral cone* is a convex polyhedral cone which does not contain any linear subspace. The cone is i -dimensional if $\dim(\text{span}_{\mathbb{R}}\{v_i \mid 1 \leq i \leq N\}) = i$ and it is *simplicial* if the generators v_1, \dots, v_N are linearly independent. Given a convex polyhedral cone σ define dual $\check{\sigma} = \{x \in \mathbb{R}^d \mid \langle x, y \rangle \geq 0 \ \forall y \in \sigma\}$. A *face* of τ of σ is the intersection of σ with a supporting hyperplane; i.e. $\tau = \{x \in \sigma \mid \langle x, u \rangle = 0\}$ for some $u \in \check{\sigma}$. It is straightforward to verify that a face of convex polyhedral cone is again a convex polyhedral cone.

A *fan* in $(\mathbb{R}^d)^*$ is any finite collection of convex polyhedral cones $\{\sigma_i\}_{i \in I}$ such that

- i. if τ is a face of σ and $\sigma \in \Sigma$ then $\tau \in \Sigma$,
- ii. $\sigma_i \cap \sigma_j$ is a face of both σ_i and σ_j .

Σ is *simplicial* if every cone is simplicial and it is *complete* if every $v \in (\mathbb{R}^d)^*$ lies in some cone of Σ . Write $|\Sigma|$ to be the set $\{v \in (\mathbb{R}^d)^* \mid v \in \sigma \text{ some } \sigma \in \Sigma\}$. Then Σ is complete if and only if $|\Sigma| = (\mathbb{R}^d)^*$. For each i , define Σ_i to be the set of i dimensional cones in Σ .

A *conewise linear function* on Σ is a continuous function $F: |\Sigma| \rightarrow \mathbb{R}$ whose restriction to every cone in Σ is a linear function. Write F_σ for the linear function that F restricts to on σ . F is called *strictly convex* if for any two distinct cones $\sigma, \sigma' \in \Sigma$ and any $x \in \sigma$ we have $F_{\sigma'}(x) > F_\sigma(x)$. A complete fan Σ that admits a strictly convex conewise linear function is called *polytopal*.

Theorem 2.1.4. *Pairs (Σ, F) consisting of a simplicial polytopal (hence complete) fan $\Sigma \subset (\mathbb{R}^d)^*$ and a strictly convex Σ -conewise linear function $F: |\Sigma| \rightarrow \mathbb{R}$ are in one-to-one correspondence with simple d -polytopes $P = \text{conv}\{F|_\sigma \mid \sigma \in \Sigma_d\} \subset ((\mathbb{R}^d)^*)^* \cong \mathbb{R}^d$.*

Proof. To go from P to (Σ, F) see [9] page 26, or [29] chapter 7. To go from (Σ, F) to

P we need to show that the points $\{F|_{\sigma}\}_{\sigma \in \Sigma_d} \subset ((\mathbb{R}^d)^*)^* \cong \mathbb{R}^d$ are the vertices of a simple convex d -polytope.

To see that the points lie in convex position in \mathbb{R}^d , we will show that each point F_{σ} minimizes a linear functional on the set $\{F|_{\sigma}\}_{\sigma \in \Sigma_d}$ and thus also on the set $\text{conv}\{F|_{\sigma} \mid \sigma \in \Sigma_d\}$. For each $\sigma \in \Sigma_d$ choose a covector ξ_{σ} which lies in the interior of σ (hence lies outside every other d -cone in Σ). Then the strict convexity of F implies that for $\sigma' \in \Sigma$ distinct from σ , that $\langle \xi_{\sigma}, F|_{\sigma'} \rangle < \langle \xi_{\sigma}, F|_{\sigma} \rangle$ (unless otherwise stated $\langle x, y \rangle$ always denotes the dual pairing for $x \in (\mathbb{R}^d)^*$ and $y \in \mathbb{R}^d$). Hence F_{σ} is minimized by ξ_{σ} . Hence the convex polytope $P = \text{conv}\{F|_{\sigma} \mid \sigma \in \Sigma_d\}$ has the vertex set $\{F|_{\sigma}\}_{\sigma \in \Sigma_d}$. It is easy to see that the edges of P are correspond to pairs $\sigma, \sigma' \in \Sigma_d$ that share a $(d - 1)$ dimensional face τ : this edge is minimized by a linear functional chosen to lie in the relative interior of τ . Since Σ is simplicial, every vertex must have exactly d -neighbors (since every cone has exactly $d(d - 1)$ -dimensional faces). This shows that Γ_P is d -valent.

Finally to see that P is a d -polytope (hence simple) we need to show that if $\sigma_0, \sigma_1, \dots, \sigma_d \in \Sigma_d$ are d -cones such that $\sigma_0 \cap \sigma_i$ is a $(d - 1)$ cone and $t_0, t_1, \dots, t_d \in \mathbb{R}$ are weights such that $\sum_{i=0}^d t_i = 0$ and

$$\sum_{i=0}^d t_i F_{\sigma_i} = 0, \quad (2.1.4)$$

then $t_i = 0$ for $0 \leq i \leq d$ (this will show that the $(d + 1)$ points $\{F_{\sigma_i} \mid 0 \leq i \leq d\}$ are affinely independent, hence affinely span a d dimensional affine subspace). To see this choose for each $1 \leq i \leq d$ a linear functional x_i that lies on the relative interior of the ray (i.e. 1-dimensional cone) contained in σ_0 but not contained in $\sigma_0 \cap \sigma_i$. Then applying x_i to both sides of (2.1.4) shows that t_i is zero. Repeating this argument for all i shows that $t_i = 0$ for all i . This completes the proof of Theorem 2.1.4. \square

The following result shows that a noncyclic d -valent, d -independent 1-skeleton in \mathbb{R}^d gives the same data as a complete simplicial fan in $(\mathbb{R}^d)^*$.

Theorem 2.1.5. *Let $(\Gamma, A, \theta) \subset \mathbb{R}^d$ be a d -valent, d -independent non-cyclic 1-skeleton. Then the set $\sigma_p := \{x \in (\mathbb{R}^d)^* \mid \langle x, A(e) \rangle \geq 0 \ \forall e \in E_p\}$ is a simplicial polyhedral d -dimensional cone and the set Σ consisting of all the σ_p ($p \in V_\Gamma$) and all the faces contained therein is a complete simplicial fan. Moreover if (Γ, A) admits an embedding, then Σ is polyhedral and the embedding provides a strictly convex conewise linear function.*

Before proving Theorem 2.1.5, we will need to establish one technical result. For $\eta \in (\mathbb{R}^d)^*$, let $\Gamma_\eta \subset \Gamma$ be the induced sub-graph on the set of vertices $\{p \in V_\Gamma \mid \langle \eta, A(e) \rangle \geq 0 \ \forall e \in E_p\}$. Note that $e \in E_{\Gamma_\eta}$ if and only if $i(e) \in V_{\Gamma_\eta}$ and $\langle \eta, A(e) \rangle = 0$.

Lemma 2.1.6. $\Gamma_\eta \subset \Gamma$ is connected for all $\eta \in (\mathbb{R}^d)^*$.

Proof. Fix a polarizing covector $\xi \in (\mathbb{R}^d)^*$ for (Γ, A) . Suppose there is some $\eta \in (\mathbb{R}^d)^*$ such that Γ_η is not connected. Then there must be two distinct vertices $p_1, p_2 \in V_\Gamma$ such that $\langle \xi, A(e) \rangle > 0$ for all $e \in (E_{p_1} \cup E_{p_2}) \cap \Gamma_\eta$. Indeed just let p_1 and p_2 be minima (with respect to the partial order induced from the polarization) on two distinct connected components of Γ_η . Thus for $M > 0$ sufficiently large, the covector $\tilde{\xi} = \xi + M \cdot \eta$ satisfies $\langle \tilde{\xi}, A(e) \rangle > 0$ for all $e \in (E_{p_1} \cup E_{p_2})$. By Theorem 1.4.5, this implies that $b_0(\Gamma, A) \geq 2$. But this is impossible since (Γ, A) is non-cyclic; see Lemma 2.2.5. \square

We are now in a position to prove Theorem 2.1.5.

Proof of Theorem 2.1.5. For each $p \in V_\Gamma$ and every $e \in E_p$, define the linear functional $X_e^p : \mathbb{R}^d \rightarrow \mathbb{R}$ by $\langle X_e^p, A(e') \rangle = \delta_{ee'}$ for $e' \in E_p$. It is straightforward to check that

$$\sigma_p = \text{pos}\{X_e^p \mid e \in E_p\}. \quad (2.1.5)$$

which shows that σ_p is a simplicial polyhedral d -cone.

We would like to see that these cones generate a complete simplicial fan in $(\mathbb{R}^d)^*$. Hence we need to show that for any two vertices $p, q \in V_\Gamma$, the intersection $\sigma_p \cap \sigma_q$ is a

face of each of σ_p and σ_q . For any pair of vertices $p, q \in V_\Gamma$ define the oriented edge sets

$$E_{pq} := \{e \in E_p \mid \langle x, A(e) \rangle > 0 \text{ some } x \in \sigma_p \cap \sigma_q\},$$

$$E_{qp} := \{e' \in E_q \mid \langle x, A(e') \rangle > 0 \text{ some } x \in \sigma_p \cap \sigma_q\}.$$

Claim. For each $e \in E_{pq}$ there is a unique $e' \in E_{qp}$ such that $X_e^p = \mu X_{e'}^q$ for some positive number μ (depending on p, q and e).

Choose $\eta \in (\mathbb{R}^d)^*$ to be a covector such that $\langle \eta, A(e) \rangle > 0$ for all $e \in E_{pq}$. By Lemma 2.1.6 the graph Γ_η is connected. Since $\eta \in \sigma_p \cap \sigma_q$, the vertices p and q must belong to Γ_η . Let $W_\eta \subset \mathbb{R}^d$ denote the sub-space spanned by edges in Γ_η ; i.e. $W_\eta = \text{span}_{\mathbb{R}}\{A(e) \mid e \in \Gamma_\eta\}$. Let $\gamma: p \rightarrow \cdots \rightarrow q$ be any path from p to q in Γ_η . The path-connection map induces a bijection

$$K_\gamma: E_{pq} \rightarrow E_{qp}$$

and we have

$$A(e) \equiv |K_\gamma(e)| \cdot A(K_\gamma(e)) \pmod{W_\eta}. \quad (2.1.6)$$

Note that for $e \in E_{pq}$ and $e' \in E_{qp}$, X_e^p and $X_{e'}^q$ both vanish identically on W_η . Since $K_\gamma(e) \in E_{qp}$, by (2.1.6) we have $X_e^p = |K_\gamma(e)| X_{K_\gamma(e)}^q$ which proves the claim.

Note that the sets $\text{pos}\{X_e^p \mid e \in E_{pq}\}$ and $\text{pos}\{X_{e'}^q \mid e' \in E_{qp}\}$ are faces of σ_p and σ_q , respectively. Hence by the claim we have

$$\sigma_p \cap \sigma_q \subseteq \text{pos}\{X_e^p \mid e \in E_{pq}\} = \text{pos}\{X_{e'}^q \mid e' \in E_{qp}\} \subseteq \sigma_p \cap \sigma_q.$$

This shows that $\sigma_p \cap \sigma_q$ is a face of each cone. Thus the cones $\{\sigma_p \mid p \in V_\Gamma\}$ generate a simplicial fan in $(\mathbb{R}^d)^*$; i.e. $\Sigma = \{\tau \mid \tau \subseteq \sigma_p, p \in V_\Gamma\}$ is a fan.

To see that the fan is complete, let $\xi \in (\mathbb{R}^d)^*$ be any generic covector for (Γ, A) . We know by Theorem 1.4.5 that the combinatorial Betti numbers are independent of choice of generic covector. Since (Γ, A) is non-cyclic, we must have $b_0(\Gamma, A) = 1$ for some,

hence every, generic covector (again see Lemma 2.2.5). Therefore there is some vertex $p_\xi \in V_\Gamma$ such that $\langle \xi, A(e) \rangle > 0$ for all $e \in E_{p_\xi}$. This implies that ξ lies in the cone σ_{p_ξ} , hence the fan is complete.

Finally, assume that $f: V_\Gamma \rightarrow \mathbb{R}^d$ is an embedding for (Γ, A) . The claim is that the assignment $\sigma_p \mapsto f(p) \in \mathbb{R}^d \cong ((\mathbb{R}^d)^*)^*$ is a strictly convex conewise linear function for the fan Σ . To see this we must show that for each covector $x \in \sigma_p$ and for every $q \neq p$, we have

$$\langle x, f(q) \rangle > \langle x, f(p) \rangle.$$

It suffices to show this for covectors x lying in the interior of σ_p . In this case the covector x is a polarizing covector for (Γ, A) with p the unique source (i.e. $\langle x, A(e) \rangle > 0$ for all $e \in E_p$). Hence there is a ξ -oriented path $\gamma: p \rightarrow p_1 \rightarrow \cdots \rightarrow p_N \rightarrow q$, and we find that

$$\begin{aligned} \langle x, A(\overline{p_i p_{i+1}}) \rangle &> 0 \\ \langle x, f(p_{i+1}) - f(p_i) \rangle &> 0 \\ \langle x, f(p_{i+1}) \rangle &> \langle x, f(p_i) \rangle \end{aligned} \tag{2.1.7}$$

Inductively from the last line of (2.1.7) we see that $\langle x, f(q) \rangle > \langle x, f(p) \rangle$, hence f is strictly convex and thus Σ is polytopal.

This completes the proof of Theorem 2.1.5. □

The remainder of this chapter will be devoted to solving the following specialized problem.

Problem 1. *When is a given d -valent 1-skeleton with connection $(\Gamma, \alpha, \theta) \subset \mathbb{R}^n$ a projection of a d -valent d -independent non-cyclic 1-skeleton with connection $(\Gamma, A, \theta) \subset \mathbb{R}^d$?*

2.2 Reduction

One of the main tools we use to attack Problem 1 is a beautiful construction introduced by Guillemin and Zara in [14] called *reduction*. In that paper, they show that reduction can be applied to any non-cyclic 3-independent 1-skeleton with connection. In this section we show how to make sense of their construction on any *reducible* 1-skeleton with connection.

2.2.1 Reducible 1-Skeleta

In [14] Guillemin and Zara were successful in proving some nice theorems about the class of 3-independent non-cyclic 1-skeleta; we will discuss their results in more detail in chapter 3. The techniques that they introduced there turn out to be quite useful for our purposes as well. In particular Guillemin and Zara showed in [14] that one can apply a *reduction* operation to a 3-independent non-cyclic 1-skeleton. We state their definition of non-cyclic again here:

Definition 2.2.1. ([14]) *A 1-skeleton $(\Gamma, \alpha) \subset \mathbb{R}^n$ is called non-cyclic if the following conditions hold:*

NC1. $(\Gamma, \alpha) \subset \mathbb{R}^n$ admits a polarization

NC2. $b_0(\Gamma_H^0, \alpha_H^0) = 1$ for every 2-slice (Γ_H^0, α_H^0) .

See Figure 14.

In the 3-independent case, a non-cyclic 1-skeleton has 2-slices that are polygons (i.e. 2-valent 1-skeleta associated to simple 2-polytopes). Without the 3-independence condition, the 2-slices can be much more complicated, as we will see in chapter 3. On the other hand if $(\Gamma, \alpha, \theta) \subset \mathbb{R}^n$ is a projection of a d -valent d -independent non-cyclic 1-

skeleton $(\Gamma, A, \theta) \subset \mathbb{R}^d$, the projection of the k -slices of (Γ, A, θ) will show up in (Γ, α, θ) as k -valent totally geodesic sub-skeleta. This motivates the following definitions.

Definition 2.2.2. *A k -face of (Γ, α, θ) is a k -valent totally geodesic sub-skeleton $(\Gamma_0, \theta_0, \alpha_0)$ with $b_0(\Gamma_0, \alpha_0) = 1$.*

For example if (Γ, α, θ) is 3-independent and non-cyclic then a 2-slice $(\Gamma_H^0, \alpha_H^0, \theta_H^0)$ is a 2-face.

In general a 1-skeleton with connection need not have any k -faces at all; for example the 1-skeleton shown in Figure 4 on 15 has no 3-faces. On the other hand a 1-skeleton of a simple polytope has many k -faces: by (ii) in Theorem 2.1.3 any k edges at a vertex span a k -face.

Definition 2.2.3. *We say that a (Γ, α, θ) has enough k -faces if for each vertex $p \in V_\Gamma$ and any subset of k edges $\{e_1, \dots, e_k\} \in E_p$, there is a unique k -face containing $\{e_1, \dots, e_k\}$.*

As we alluded to above, the 1-skeleton of a simple d -polytope has enough k -faces for $0 \leq k \leq d$ by (ii) in Theorem 2.1.3. Of particular importance to the reduction technique, as we shall see, are the 2-faces.

Definition 2.2.4. *A 1-skeleton with connection $(\Gamma, \alpha, \theta) \subset \mathbb{R}^n$ is called reducible if*

1. *it admits a polarization and*
2. *it has enough 2-faces.*

Definition 2.2.4 is a generalization of Guillemin and Zara's notion of non-cyclic (as in Definition 2.2.1) in the sense that if $(\Gamma, \alpha, \theta) \subset \mathbb{R}^n$ is 3-independent and non-cyclic, then it is also reducible.

In Figure 16 both 1-skeleta shown admit a polarization; however the first one, equipped with the connection that makes the outer hexagon a totally geodesic sub-skeleton, does

not have enough 2-faces, whereas the second one, equipped with the connection that makes the outer hexagon a totally geodesic sub-skeleton, does have enough 2-faces.

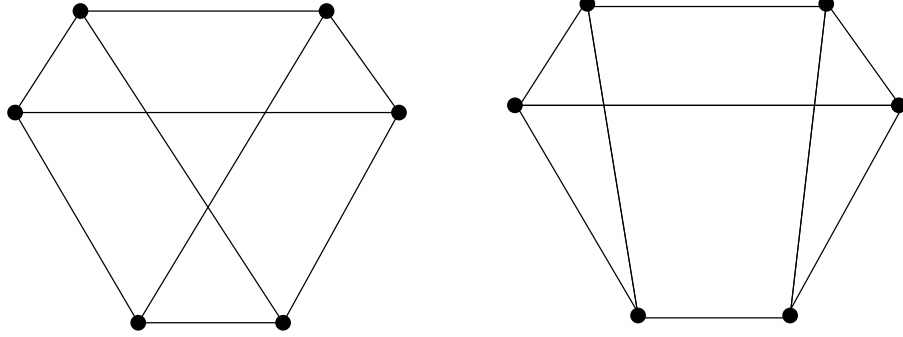

Figure 16. enough 2-faces?

We have the following lemma which we have already appealed to the previous section.

Lemma 2.2.5. *If $(\Gamma, \alpha, \theta) \subset \mathbb{R}^n$ is any d -valent reducible 1-skeleton then $b_0(\Gamma, \alpha) = 1$.*

Proof. Fix a polarizing vector $\xi \in (\mathbb{R}^n)^*$ and fix a total ordering $<$ on Γ that is compatible with ξ in the sense that if $\overline{pq} \in E_\Gamma$ and $\langle \xi, \alpha(\overline{pq}) \rangle > 0$ then $p < q$ (for instance we could choose the total ordering coming from a ξ -compatible Morse function $\phi: V_\Gamma \rightarrow \mathbb{R}$). We call a vertex $p \in V_\Gamma$ a *source* (with respect to ξ) if for every $e \in E_p$ we have $\langle \xi, \alpha(e) \rangle > 0$. Let $x \in V_\Gamma$ denote the smallest vertex with respect to $<$. Then x is a source with respect to ξ . For each source $y \in V_\Gamma$ define the set $P(y) \subset V_\Gamma$ to be the set of vertices that can be reached by a ξ -increasing path from y . Note that

$$V_\Gamma = \bigcup_{y \text{ a source}} P(y).$$

Define $\mathcal{S}_x(\xi)$ to be the set of sources of Γ distinct from x such that if $y \in \mathcal{S}_x(\xi)$ then $P(x) \cap P(y) \neq \emptyset$. Note that if (Γ, α) admits more than one source with respect to ξ , then since Γ is connected (recall that the underlying graph of a 1-skeleton is *always* assumed to be connected), $\mathcal{S}_x(\xi)$ had better be non-empty. Therefore to produce a contradiction we will show that $\mathcal{S}_x(\xi) = \emptyset$.

Assume that $\mathcal{S}_x(\xi) \neq \emptyset$. Define the function $f: \mathcal{S}_x(\xi) \rightarrow V_\Gamma$ by $f(y) = z$ where z is the smallest vertex (with respect to $<$) in $P(x) \cap P(y)$. f must achieve a minimum at some $y_0 \in \mathcal{S}_x(\xi)$; set $f(y_0) = z_0$. There exist vertices $v \in P(x)$ and $w \in P(y_0)$ such that $\overline{z_0v}, \overline{z_0w} \in E_z$ are oriented into z_0 with respect to ξ (i.e. $v, w < z_0$). By the minimality of z_0 we must have $v \neq w$. Let Q be the unique 2-face spanned by the edges $\overline{z_0v}, \overline{z_0w}$ and let $s_Q \in V_Q$ be the unique source of Q with respect to the polarization induced on Q by ξ . Then there is some source $y' \in V_\Gamma$ such that $s_Q \in P(y')$. There are two cases to consider:

1. $y' = x$ in which case $f(y_0) \leq w < z_0$, contradicting the minimality of z_0 .
2. $y' \neq x$ in which case $y' \in \mathcal{S}_x(\xi)$ and $f(y') \leq v < z_0$, again contradicting the minimality of z_0 .

Hence we conclude that $\mathcal{S}_x(\xi)$ must have been empty in the first place and this concludes the proof of Lemma 2.2.5. □

Before introducing the reduction operation, we must introduce one more preliminary notion.

2.2.2 Pre-1-Skeleta and Generalized 1-Skeleta

In order to use reduction to solve the problem at hand we must loosen the genericity requirements on the projection maps. In the next section we will see that the reduction operation takes a d -valent k -independent 1-skeleton with connection in \mathbb{R}^n (for $k \geq 3$), and produces a $(d - 1)$ -valent $(k - 1)$ -independent 1-skeleton with connection in \mathbb{R}^{n-1} . If $k = 2$ then reduction still produces something resembling a 1-skeleton with a graph, connection, and even compatibility constants, but the assignment of directions to the edges may fail to satisfy A1 of Definition 1.1.2. In this case reduction will produce a *generalized* 1-skeleton.

Let (Γ, θ) be a d -valent graph-connection pair.

Definition 2.2.6. A compatibility system for the pair (Γ, θ)

$$\lambda := \{\lambda_e\}_{e \in E_\Gamma}$$

is a collection of maps $\lambda_e: E_{i(e)} \rightarrow \mathbb{R}_+$ indexed by the oriented edges of Γ that satisfy the following rule:

$$\lambda_{\bar{e}} \circ \theta_e = \frac{1}{\lambda_e}$$

for every pair $e, \bar{e} \in E_\Gamma$.

Definition 2.2.7. A pre-1-skeleton is a triple consisting of a d -valent graph Γ , a connection θ on Γ and a compatibility system for the pair (Γ, θ) . We denote this by $(\Gamma, \theta, \lambda)$.

Definition 2.2.8. A generalized axial function α compatible with the pre-1-skeleton $(\Gamma, \theta, \lambda)$ is a map $\alpha: E_\Gamma \rightarrow \mathbb{R}^n$ that satisfies the following axioms:

gA1. For each $e \in E_\Gamma$ there is some $m_e > 0$ such that $\alpha(e) = -m_e \alpha(\bar{e})$

gA2. For every $e \in E_\Gamma$ and each $e' \in E_{i(e)} \setminus \{e\}$ we have

$$\alpha(e') - \lambda_e(e') \alpha(\theta_e(e')) = c_e(e') \cdot \alpha(e)$$

for some $c_e(e') \in \mathbb{R}$.

Definition 2.2.9. A d -valent generalized 1-skeleton in \mathbb{R}^n is a quadruple consisting of the data triple of a d -valent pre-1-skeleton $(\Gamma, \theta, \lambda)$ together with a generalized axial function $\alpha: E_\Gamma \rightarrow \mathbb{R}^n$ compatible with the pre-1-skeleton. We denote this by $(\Gamma, \alpha, \theta, \lambda) \subset \mathbb{R}^n$.

Definition 2.2.10. Two generalized 1 skeleta $(\Gamma, \alpha, \theta, \lambda) \subset \mathbb{R}^n$ and $(\tilde{\Gamma}, \tilde{\alpha}, \tilde{\theta}, \tilde{\lambda}) \subset \mathbb{R}^n$ are equivalent if

$$i. (\Gamma, \theta) = (\tilde{\Gamma}, \tilde{\theta})$$

ii. there exists a function $\kappa: E_\Gamma \rightarrow \mathbb{R}_+$ such that for every $e \in E_\Gamma$, we have

$$\lambda_e(e') = \frac{\kappa(e')}{\kappa(\theta_e(e'))} \tilde{\lambda}_e(e'),$$

for each $e' \in E_{i(e)} \setminus \{e\}$

iii. the following diagram commutes:

$$\begin{array}{ccc} \mathbb{R}^n & \xleftarrow{id} & \mathbb{R}^n \\ C\alpha \uparrow & & \uparrow \tilde{\alpha} \\ E_\Gamma & \xrightarrow{\pi} & E_{\tilde{\Gamma}} \end{array} .$$

We will denote equivalence of generalized 1-skeleta by

$$(\Gamma, \alpha, \theta, \lambda) \equiv (\tilde{\Gamma}, \tilde{\alpha}, \tilde{\theta}, \tilde{\lambda})$$

Notice that a 1-skeleton with connection together with its compatibility constants is also a generalized 1-skeleton.

2.2.3 Reduction and Cross-Sections

In this construction, we start with the data of a (reducible) 1-skeleton, but the resulting data will be that of a generalized 1-skeleton.

Let $(\Gamma, \alpha, \theta) \subset \mathbb{R}^n$ be a reducible (as in Definition 2.2.4) d -valent 1-skeleton with connection with compatibility constants $\lambda = \{\lambda_e\}_{e \in E_\Gamma}$. Fix a polarizing vector $\xi \in (\mathbb{R}^n)^*$ and a ξ -compatible Morse function $\phi: V_\Gamma \rightarrow \mathbb{R}$.

Let $(\Gamma_0, \alpha_0, \theta_0) \subset (\Gamma, \alpha, \theta)$ be a 2-face. We can label the vertices $V_0 = \{p_0, \dots, p_N\}$ such that $\overline{p_i p_{i+1}} \in E_0$ for $0 \leq i \leq N$. Hence we can represent $(\Gamma_0, \alpha_0, \theta_0)$ as a loop in Γ , $p_0 \rightarrow \dots \rightarrow p_0$, and we can do this in two ways (up to cyclic permutation of the indicies): $Q := \{p_0 \rightarrow p_1 \rightarrow \dots \rightarrow p_N \rightarrow p_0\}$ and $\bar{Q} := \{p_0 \rightarrow p_N \rightarrow \dots \rightarrow p_1 \rightarrow p_0\}$.

Each representation of $(\Gamma_0, \alpha_0, \theta_0)$ is called an *oriented 2-face*, denoted by Q or \bar{Q} for notational convenience.

Let \mathcal{F}_2 denote the set of oriented 2-faces of (Γ, α, θ) . For $Q \in \mathcal{F}_2$ let

$$M_\xi(Q) = \max_{v \in Q}(\phi(v))$$

and

$$m_\xi(Q) = \min_{v \in Q}(\phi(v)).$$

Fix $c \in \mathbb{R}$ a ϕ -regular value. Define the new graph $\Gamma_c = (V_c, E_c)$ whose vertex set is defined to be the oriented edges at c -level:

$$V_c = \{\overline{pq} \in E_\Gamma \mid \phi(p) < c < \phi(q)\}.$$

Consider a 2-face $Q \in \mathcal{F}_2$ at c -level, meaning that $m_\xi(Q) < c < M_\xi(Q)$. Let b and t be vertices of Q such that $\phi(b) = m_\xi(Q)$ and $\phi(t) = M_\xi(Q)$. Then since Q is a 2-face we have $b_0(Q) = 1$ hence there are exactly two ξ -oriented paths from b to t , γ_ℓ and γ_r . For each such path, there is exactly one directed edge that crosses the c -level; i.e. there exist unique directed edges $\overline{pq}, \overline{vw} \in V_c$ such that $\gamma_\ell: b \rightarrow \cdots p \rightarrow q \cdots \rightarrow t$ and $\gamma_r: b \rightarrow \cdots v \rightarrow w \cdots \rightarrow t$. Moreover only one of the oriented edges $\overline{pq}, \overline{vw}$ is oriented with respect to Q ; i.e. $Q = \{b \rightarrow \cdots \rightarrow p \rightarrow q \rightarrow \cdots \rightarrow w \rightarrow v \rightarrow \cdots \rightarrow b\}$ and $\bar{Q} = \{b \rightarrow \cdots \rightarrow v \rightarrow w \rightarrow \cdots \rightarrow q \rightarrow p \rightarrow \cdots \rightarrow b\}$. In this way an oriented 2-face $Q \in \mathcal{F}_2$ at the c -level gives an ordered pair of “vertices” in V_c ; we write $i(Q) = \overline{pq}$ and $t(Q) = \overline{vw}$. Therefore we define the oriented edge set of Γ_c to be the set of oriented 2-faces at c -level:

$$E_c = \{Q \in \mathcal{F}_2 \mid m_\xi(Q) < c < M_\xi(Q)\}.$$

For every $\overline{pq} \in V_c$ the oriented 2-faces containing \overline{pq} are in one-to-one correspondence with the oriented edges $E_p \setminus \{\overline{pq}\}$. Indeed since (Γ, α, θ) has enough 2-faces (this is part of being reducible), any two oriented edges at p span an oriented 2-face, hence any oriented

edge in $E_p \setminus \{\overline{pq}\}$ together with \overline{pq} define an oriented 2-face Q with $i(Q) = \overline{pq}$. Thus Γ_c is a $(d - 1)$ -valent graph ($(d - 1)$ is the number of oriented edges in the set $|E_p \setminus \{\overline{pq}\}|$).

There are *two* natural connections on Γ_c . Fix $Q \in E_c$ and let $i(Q) = \overline{pq}$ and $t(Q) = \overline{vw}$.

Let

$$\gamma_Q^u: q = r_1 \rightarrow r_2 \rightarrow \dots \rightarrow r_{k-1} \rightarrow r_k = w$$

be the *upper path* in Q from q to w , meaning that $\phi(r_i) > c$ for $1 \leq i \leq k$. Let

$$\gamma_Q^d: p = t_1 \rightarrow t_2 \rightarrow \dots \rightarrow t_{m-1} \rightarrow t_m = v$$

be the *lower path* in Q from p to v , meaning that $\phi(t_j) < c$ for $1 \leq j \leq m$.

The set $(E_c)_{\overline{pq}} \setminus \{Q\}$ is in one-to-one correspondence with the oriented edges normal to Q at p (or q), N_p^0 ($\cong N_q^0$). Similarly the set $(E_c)_{\overline{vw}} \setminus \{\bar{Q}\}$ is in one-to-one correspondence with the oriented edges normal to \bar{Q} at v (or w), N_v^0 ($\cong N_w^0$). The normal path-connection maps on Γ ,

$$K_{\gamma_Q^u}^\perp: N_q^0 \rightarrow N_w^0$$

and

$$K_{\gamma_Q^d}^\perp: N_p^0 \rightarrow N_v^0,$$

define connection maps on Γ_c : The *up connection* map along $Q \in E_c$, $(\theta_c^u)_Q$, is defined to be the unique map which makes the following diagram commute:

$$\begin{array}{ccc} (E_c)_{\overline{pq}} \setminus \{Q\} & \xrightarrow{(\theta_c^u)_Q} & (E_c)_{\overline{vw}} \setminus \{\bar{Q}\} \\ \cong \downarrow & & \downarrow \cong \\ N_q^0 & \xrightarrow{K_{\gamma_Q^u}^\perp} & N_w^0. \end{array}$$

The *down connection* map along $Q \in E_c$, $(\theta_c^d)_Q$, is defined analogously by

$$\begin{array}{ccc} (E_c)_{\overline{pq}} \setminus \{Q\} & \xrightarrow{(\theta_c^d)_Q} & (E_c)_{\overline{vw}} \setminus \{Q\} \\ \cong \downarrow & & \downarrow \cong \\ N_p^0 & \xrightarrow{K_{\gamma_Q^d}^\perp} & N_v^0. \end{array}$$

We have attempted to illustrate the situation in Figure 17. The bold line segments joining the open dots represent the oriented edges issuing from the vertices \overline{pq} and \overline{vw} in V_c . The line segments issuing from vertices of Q but not lying in Q itself represent those edges normal to Q .

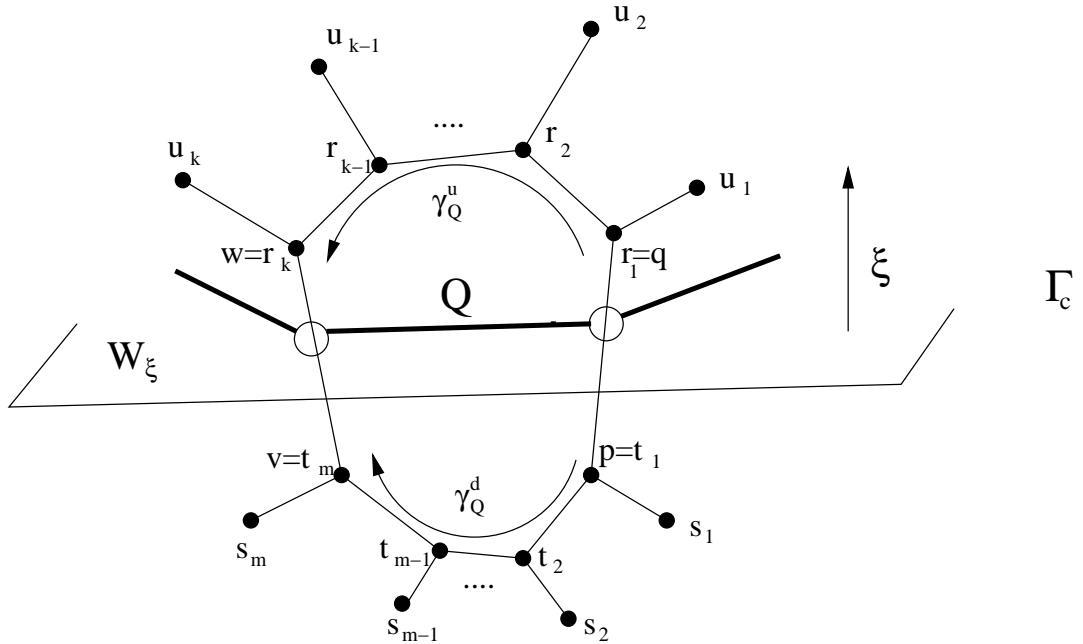

Figure 17. the c -cross-section

We define compatibility constants for the graph-connection pairs (Γ_c, θ_c^u) and (Γ_c, θ_c^d)

similarly. Define the function $(\lambda_c^u)_Q: (E_c)_{\overline{pq}} \rightarrow \mathbb{R}_+$ by

$$\begin{array}{ccc}
 (E_c)_{\overline{pq}} \setminus \{Q\} & \xrightarrow{(\lambda_c^u)_Q} & \mathbb{R}_+ \\
 \cong \downarrow & \nearrow |K_{\gamma_Q^u}(-)| & \\
 N_q^0 & &
 \end{array}$$

where the lower map is defined by $e \mapsto |K_{\gamma_Q^u}(e)|$ as in Definition 1.3.5. We similarly define function $(\lambda_c^d)_Q: (E_c)_{\overline{pq}} \rightarrow \mathbb{R}_+$ by

$$\begin{array}{ccc}
 (E_c)_{\overline{pq}} \setminus \{Q\} & \xrightarrow{(\lambda_c^d)_Q} & \mathbb{R}_+ \\
 \cong \downarrow & \nearrow |K_{\gamma_Q^d}(-)| & \\
 N_p^0 & &
 \end{array}$$

It is straightforward to verify that the triples $(\Gamma_c, \theta_c^u, \lambda_c^u)$ and $(\Gamma_c, \theta_c^d, \lambda_c^d)$ are pre 1-skeleta in the sense of Definition 2.2.7. Indeed since the path-connection numbers at e satisfy

$$|K_{\bar{\gamma}_Q^u}(K_{\gamma_Q^u}(e))| = \frac{1}{|K_{\gamma_Q^u}(e)|} \quad (2.2.1)$$

for all $e \in N_q^0$, we see that

$$(\lambda_c^u)_Q \circ (\theta_c^u)_Q = \frac{1}{(\lambda_c^u)_Q}.$$

Similarly for $(\lambda_c^d)_Q$.

Therefore we have two possibly distinct pre-1-skeleta with the same underlying graph Γ_c , namely

$$(\Gamma_c, \theta_c^u, \lambda_c^u)$$

and

$$(\Gamma_c, \theta_c^d, \lambda_c^d).$$

For each pre-1-skeleton defined above, we can define a compatible, generalized axial function on Γ_c as follows. Let $W_\xi \subset \mathbb{R}^n$ denote the sub-space annihilated by ξ . Denote by $\wedge^2 \mathbb{R}^n$ the vector space of alternating two tensors generated by elements of the form $x \wedge y (= -y \wedge x)$ for $x, y \in \mathbb{R}^n$. Let $\iota: \wedge^2 \mathbb{R}^n \rightarrow \mathbb{R}^n$ denote the ξ -interior product map defined by $\iota(x \wedge y) = \langle \xi, x \rangle y - \langle \xi, y \rangle x$. As above let $Q \in E_c$ be an oriented 2-face with $i(Q) = \overline{pq}$ and $t(Q) = \overline{vw}$. Let

$$\gamma_j^u: q = r_1 \rightarrow r_2 \rightarrow \dots \rightarrow r_j$$

be the partial upper path in Q from q to r_j and

$$\gamma_j^d: p = t_1 \rightarrow t_2 \rightarrow \dots \rightarrow t_j$$

the partial lower path in Q from p to t_j . Then $\gamma_k^u = \gamma_Q^u: q \rightarrow \dots \rightarrow r_k = w$ and $\gamma_m^d = \gamma_Q^d: p \rightarrow \dots \rightarrow t_m = v$ as above. Our convention will be to let $p = r_0$ and $v = r_{k+1}$ and to let $q = t_0$ and $w = t_{m+1}$.

Define the function

$$\alpha_c^u: E_c \rightarrow W_\xi$$

by

$$\alpha_c^u(Q) = \frac{\iota(\alpha(r_1 r_0) \wedge \alpha(r_1 r_2))}{\langle \xi, \alpha(r_1 r_0) \rangle}.$$

Similarly define

$$\alpha_c^d: E_c \rightarrow W_\xi$$

by

$$\alpha_c^d(Q) = \frac{\iota(\alpha(t_1 t_0) \wedge \alpha(t_1 t_2))}{\langle \xi, \alpha(t_1 t_0) \rangle}.$$

Lemma 2.2.11. *The functions α_c^u and α_c^d are compatible with the pre-1-skeleta $(\Gamma_c, \theta_c^u, \lambda_c^u)$ and $(\Gamma_c, \theta_c^d, \lambda_c^d)$, respectively.*

Proof. We will show that α_c^u is compatible with the pre-1-skeleton $(\Gamma_c, \theta_c^u, \lambda_c^u)$. The proof that α_c^d is compatible with $(\Gamma_c, \theta_c^d, \lambda_c^d)$ is similar. We will follow the argument presented in [14] more or less verbatim.

For vectors $a, b, c \in \mathbb{R}^n$ we will write

$$a \equiv b \pmod{c}$$

to mean that

$$a - b \in \text{span}_{\mathbb{R}}\{c\}.$$

Fix $R \in (E_c)_{\overline{pq}} \setminus \{Q\}$. We want to show that

$$\alpha_c^u(R) - (\lambda_c^u)_Q(R) \cdot \alpha_c^u((\theta_c^u)_Q(R)) \equiv 0 \pmod{\alpha_c^u(Q)}.$$

Let $\overline{qu_1} \in N_q^0$ be the oriented edge at $q (= r_1)$ corresponding to R . Let $\overline{r_j u_j} = K_{r_j^u}^\perp(\overline{r_1 u_1}) \in N_{r_j}^0$. Then we have

$$\alpha_c^u(R) = \frac{\iota(\alpha(\overline{r_1 r_0}) \wedge \alpha(\overline{r_1 u_1}))}{\langle \xi, \alpha(\overline{r_1 r_0}) \rangle}$$

and

$$\alpha_c^u((\theta_c^u)_Q(R)) = \frac{\iota_{\xi}(\alpha(\overline{r_k r_{k+1}}) \wedge \alpha(\overline{r_k u_k}))}{\langle \xi, \alpha(\overline{r_k r_{k+1}}) \rangle}.$$

The reader may find it helpful to consult Figure 17 here.

For convenience we will adopt the following temporary notation. Let

$$v_j := \frac{\alpha(\overline{r_j r_{j-1}})}{\langle \xi, \alpha(\overline{r_j r_{j-1}}) \rangle}$$

$$v'_j := \frac{\alpha(\overline{r_j r_{j+1}})}{\langle \xi, \alpha(\overline{r_j r_{j+1}}) \rangle}$$

and

$$w_j := \alpha(\overline{r_j u_j}).$$

We then have

$$\alpha_c^u(Q) = \iota(v_1 \wedge v'_1)$$

$$\alpha_c^u(R) = \iota(v_1 \wedge w_1)$$

and

$$\alpha_c^u((\theta_c^u)_Q(R)) = \iota(v'_k \wedge w_k).$$

A direct computation will verify that

$$\iota(v'_j \wedge w_j) \equiv \iota(v_j \wedge w_j) \pmod{\alpha_c^u(Q)} \quad (2.2.2)$$

Also we have

$$w_j - \lambda_{\overline{r_j r_{j+1}}}(\overline{r_j u_j}) w_{j+1} \equiv 0 \pmod{v'_j}$$

by A3 in Definition 1.1.2. Hence we get that

$$\iota(v'_j \wedge w_j) = \lambda_{\overline{r_j r_{j+1}}}(\overline{r_j u_j}) \iota(v_{j+1} \wedge w_{j+1}). \quad (2.2.3)$$

Combining (2.2.2) and (2.2.3) we get

$$\iota(v_j \wedge w_j) \equiv \lambda_{\overline{r_j r_{j+1}}}(\overline{r_j u_j}) \iota(v_{j+1} \wedge w_{j+1}) \pmod{\alpha_c^u(Q)}$$

hence inductively we get

$$\iota(v_1 \wedge w_1) \equiv |K_{\gamma_k^u}(\overline{r_1 u_1})| \cdot \iota(v_k \wedge w_k) \pmod{\alpha_c^u(Q)}. \quad (2.2.4)$$

Combining (2.2.2) with (2.2.4) we get

$$\iota(v_1 \wedge w_1) \equiv |K_{\gamma_k^u}(\overline{r_1 u_1})| \cdot \iota(v'_k \wedge w_k) \pmod{\alpha_c^u(Q)},$$

hence we see that

$$\alpha_c^u(R) - (\lambda_c^u)_Q(R) \alpha_c^u(R') \equiv 0 \pmod{\alpha_c^u(Q)}.$$

□

Thus we get two (possibly distinct) generalized 1 skeleta structures on the $(d-1)$ -valent graph Γ_c ; we have the *up c-cross-section* of Γ , $(\Gamma_c, \alpha_c^u, \theta_c^u, \lambda_c^u)$, and the *down c-cross-section* of Γ , $(\Gamma_c, \alpha_c^d, \theta_c^d, \lambda_c^d)$.

2.3 Product Constructions and the Blow-Up

In this section we will describe some basic constructions that allow us to “build” new 1-skeleta from old. These constructions are crucial to what follows in this chapter, and they will come up again in chapter 4.

2.3.1 Direct Product

Let $(\Gamma', \alpha', \theta') \subset \mathbb{R}^n$ and $(\Gamma_0, \alpha_0, \theta_0) \subset \mathbb{R}^m$ be 1-skeleta with connections. We define a new 1-skeleton with connection $(\Gamma, \alpha, \theta) \subset \mathbb{R}^n \times \mathbb{R}^m$ as follows. Set

$$V_\Gamma := V_{\Gamma'} \times V_{\Gamma_0},$$

and

$$E_\Gamma := E_{\Gamma'} \times V_{\Gamma_0} \sqcup V_{\Gamma'} \times E_{\Gamma_0}.$$

Then $\Gamma = (V_\Gamma, E_\Gamma)$ is just the *product graph*. There is a natural connection θ on Γ defined by

$$\theta_e(\tilde{e}) = \begin{cases} \theta'_{e'}(\tilde{e}') \times v_0 & \text{if } e = e' \times v_0 \text{ and } \tilde{e} = \tilde{e}' \times v_0 \\ t(e') \times \tilde{e}_0 & \text{if } e = e' \times v_0 \text{ and } \tilde{e} = i(e') \times \tilde{e}_0 \\ v' \times (\theta_0)_{e_0}(\tilde{e}_0) & \text{if } e = v' \times e_0 \text{ and } \tilde{e} = v' \times \tilde{e}_0 \\ \tilde{e}' \times t(e_0) & \text{if } e = v' \times e_0 \text{ and } \tilde{e} = \tilde{e}' \times i(e_0) \end{cases}.$$

θ is called the *product connection* on Γ .

There is a natural axial function on Γ that is compatible with θ defined by

$$\alpha: E_\Gamma \rightarrow \mathbb{R}^n \times \mathbb{R}^m$$

$$\alpha(e) = \begin{cases} (\alpha'(e'), 0) & \text{if } e = e' \times v_0 \\ (0, \alpha_0(e_0)) & \text{if } e = v' \times e_0. \end{cases}$$

It is straight forward to check that α is an axial function compatible with the graph-connection pair (Γ, θ) . The 1-skeleton $(\Gamma, \alpha, \theta) \subset \mathbb{R}^n \times \mathbb{R}^m$ is called the *direct product 1-skeleton* with factors $(\Gamma', \alpha', \theta')$ and $(\Gamma_0, \alpha_0, \theta_0)$. We can compute the compatibility system for (Γ, α, θ) in terms of the compatibility system for the factors. We have

$$\lambda_e(\tilde{e}) = \begin{cases} \lambda_{e'}(\tilde{e}') & \text{if } e = e' \times \{v_0\}, \tilde{e} = \tilde{e}' \times \{v_0\} \\ \lambda_{e_0}(\tilde{e}_0) & \text{if } e = \{v'\} \times e_0, \tilde{e} = \{v'\} \times \tilde{e}_0 \\ 1 & \text{otherwise.} \end{cases}$$

The 1-skeleton in Figure 18 is a direct product whose factors are the triangle in \mathbb{R}^2 and the single edge in \mathbb{R} .

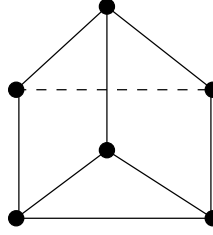

Figure 18. direct product

2.3.2 Tilted Product

Let $(\Gamma', \alpha', \theta') \subset \mathbb{R}^n$ and $(\Gamma_0, \alpha_0, \theta_0) \subset \mathbb{R}^m$ be given 1-skeleta with connections. As before let $(\Gamma, \alpha, \theta) \subset \mathbb{R}^n \times \mathbb{R}^m$ denote the direct product 1-skeleton.

Definition 2.3.1. A tilt on $(\Gamma, \alpha, \theta) \subset \mathbb{R}^n \times \mathbb{R}^m$ is a map

$$\eta: V_{\Gamma'} \rightarrow \text{Hom}_{\mathbb{R}}(\mathbb{R}^m, \mathbb{R}^n)$$

with the property that for each $y \in \mathbb{R}^m$, composition with the evaluation map

$$\epsilon_y: \text{Hom}_{\mathbb{R}}(\mathbb{R}^m, \mathbb{R}^n) \rightarrow \mathbb{R}^n$$

$$\epsilon_y(f) := f(y)$$

gives an equivariant cohomology class on (Γ', α') ,

$$\epsilon_y \circ \eta \in H(\Gamma', \alpha').$$

We can use a tilt on the direct product 1-skeleton to define another axial function for the pair (Γ, θ) .

Definition 2.3.2. Given a tilt η on (Γ, α, θ) , define the (η) -tilted axial function

$$\alpha_\eta: E_\Gamma \rightarrow \mathbb{R}^n \times \mathbb{R}^m$$

by

$$\alpha_\eta(e) = \begin{cases} \begin{pmatrix} \alpha'(e') \\ 0 \end{pmatrix} & \text{if } e = e' \times \{v_0\} \\ \begin{pmatrix} \eta_{v'}(\alpha_0(e_0)) \\ \alpha_0(e_0) \end{pmatrix} & \text{if } e = \{v'\} \times e_0 \end{cases}$$

It is straight forward to check that α_η is actually an axial function for the pair (Γ, θ) . Indeed, label the oriented edges of the form $e' \times \{v_0\}$ by E_Γ^h (“h” for horizontal) and those of the form $\{v'\} \times e_0$ by E_Γ^v (“v” for vertical).

Along a vertical edge $e \in E_\Gamma^v$ it follows by the linearity of $\eta_{v'}$ that

$$\alpha_\eta(\tilde{e}) - \lambda_e(\tilde{e}) \cdot \alpha_\eta(\theta_e(\tilde{e})) \equiv 0 \pmod{\alpha_\eta(e)} \quad (2.3.1)$$

for all $\tilde{e} \in E_{i(e)}$.

Along a horizontal edge $e \in E_\Gamma^h$, (2.3.1) clearly holds for $\tilde{e} \in E_\Gamma^h$. On the other hand, if $\tilde{e} \in E_\Gamma^v$ then we have

$$\alpha_\eta(\tilde{e}) = \begin{pmatrix} \eta_{v'}(\alpha_0(e_0)) \\ \alpha_0(e_0) \end{pmatrix}$$

and

$$\alpha_\eta(\theta_e(\tilde{e})) = \begin{pmatrix} \eta_{v''}(\alpha_0(e_0)) \\ \alpha_0(e_0) \end{pmatrix}$$

where $e = \overline{v'v''} \times \{v_0\}$ and $\tilde{e} = \{v'\} \times e_0$. Thus (2.3.1) becomes

$$\begin{pmatrix} \eta_{v'}(\alpha_0(e_0)) \\ \alpha_0(e_0) \end{pmatrix} - \begin{pmatrix} \eta_{v''}(\alpha_0(e_0)) \\ \alpha_0(e_0) \end{pmatrix} = \begin{pmatrix} \eta_{v'}(\alpha_0(e_0)) - \eta_{v''}(\alpha_0(e_0)) \\ 0 \end{pmatrix}.$$

Since the function $\eta(\alpha_0(e_0)): V_{\Gamma'} \rightarrow \mathbb{R}^n$ is an equivariant class for (Γ', α') we conclude that $\eta_{v'}(\alpha_0(e_0)) - \eta_{v''}(\alpha_0(e_0)) \equiv 0 \pmod{\alpha'(\overline{v'v''})}$. Hence α_η is indeed an axial function for the pair (Γ, θ) .

Definition 2.3.3. We call $(\Gamma, \alpha_\eta, \theta) \subset \mathbb{R}^n \times \mathbb{R}^m$ the (η) -tilted product 1-skeleton with straight factor $(\Gamma', \alpha', \theta')$ and tilted factor $(\Gamma_0, \alpha_0, \theta_0)$.

The 1-skeleton in Figure 19 is a tilted product in \mathbb{R}^3 with straight factor the single edge in \mathbb{R} and tilted factor the triangle in \mathbb{R}^2 . Compare this with the direct product 1-skeleton shown in Figure 18.

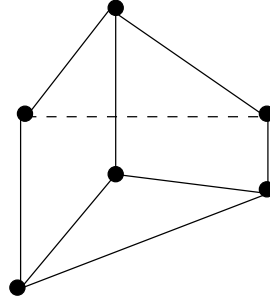

Figure 19. tilted product

Note that the compatibility system for $(\Gamma, \alpha_\eta, \theta)$ is the same as the compatibility system for (Γ, α, θ) .

2.3.3 Blow-Up

Fix a d -valent 1-skeleton with connection $(\Gamma, \alpha, \theta) \subset \mathbb{R}^n$ with compatibility constants $\lambda = \{\lambda_e\}_{e \in E_\Gamma}$ and let $(\Gamma_0, \alpha_0, \theta_0)$ be a k -valent totally geodesic sub-skeleton. We will define a new graph $\Gamma^\sharp = (V^\sharp, E^\sharp)$ by “replacing” Γ_0 by a new $(d-1)$ -valent sub-graph.

Let $N^0 = \bigsqcup_{p \in V_{\Gamma_0}} N_p^0$ be the set of oriented edges normal to Γ_0 . Define the vertex set of Γ^\sharp to be

$$V^\sharp := V_\Gamma \setminus V_0 \sqcup N^0.$$

We will write z_e to denote a vertex corresponding to an oriented edge $e \in N^0$ or we may write z_e^p to denote the vertex corresponding to $e \in N_p^0$.

There is a natural map of sets

$$\beta: V^\sharp \rightarrow V_\Gamma$$

$$\beta(x) = \begin{cases} q & \text{if } x = q \in V_\Gamma \setminus V_0 \\ p & \text{if } x = z_e \text{ for some } e \in N_p^0 \end{cases}$$

We declare two vertices $x, y \in V_\Gamma^\sharp$ to be adjacent if $\beta(x) = \beta(y)$ or $\overline{\beta(x)\beta(y)} \in E_\Gamma$. Denote this oriented edge set E^\sharp . To avoid confusion we will use the letter ϵ to denote oriented edges in E^\sharp . For a vertex $q \in V_\Gamma \setminus V_0$ the map β furnishes a bijection between the oriented edge sets E_q^\sharp and $E_{\beta(q)}$. For vertices $z_e^p \in V^\sharp$ there is still a bijective correspondence between the oriented edge sets $E_{z_e^p}^\sharp$ and $E_{\beta(z_e^p)}$ given by:

$$\begin{aligned} E_{z_e^p}^\sharp &\xrightarrow{\psi} E_p & (2.3.2) \\ \overline{z_e^p z_{e'}^p} &\longrightarrow e \\ \overline{z_e^p z_f^q} &\longrightarrow \overline{pq} \\ \overline{z_e^p [t(e)]} &\longrightarrow e \end{aligned}$$

(in the last line $t(e)$ denotes the terminal vertex of e in $V_\Gamma \setminus V_0$). See Figure 20. In particular the graph Γ^\sharp is d -valent. We call Γ^\sharp the *blow-up graph* of Γ along Γ_0 . The sub-graph $\Gamma_0^\sharp := \beta^{-1}(\Gamma_0) \subset \Gamma^\sharp$ is a connected $(d-1)$ -valent sub-graph called the *singular locus* of the blow-up.

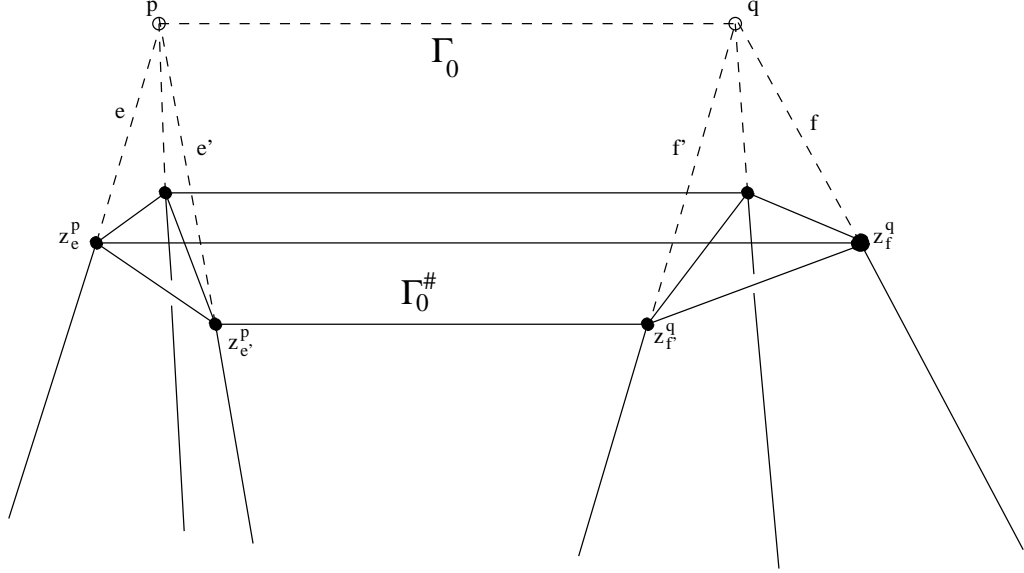

Figure 20. blow-up along a sub-skeleton

We want to define a connection and compatibility system on Γ^\sharp . The map $\beta: V^\sharp \rightarrow V_\Gamma$ extends, by its very definition, to a morphism of graphs $\beta: \Gamma^\sharp \rightarrow \Gamma$. For each vertex $x \in V^\sharp$ denote by $(E_x^\sharp)^h := \beta^{-1}(E_{\beta(x)})$, the horizontal edges at x and by $(E_x^\sharp)^v := E_x^\sharp \setminus (E_x^\sharp)^h$ the vertical edges. For each $\epsilon \in E^\sharp$ define the map $\theta_\epsilon^\sharp: E_{i(\epsilon)}^\sharp \rightarrow E_{t(\epsilon)}^\sharp$ so that the following diagram commutes:

$$\begin{array}{ccc} E_{i(\epsilon)}^\sharp & \xrightarrow{\theta_\epsilon^\sharp} & E_{t(\epsilon)}^\sharp \\ \cong \downarrow & & \downarrow \cong \\ E_{\beta i(\epsilon)} & \xrightarrow{\cong} & E_{\beta t(\epsilon)}; \end{array} \quad (2.3.3)$$

here the right (resp. left) vertical map labelled \cong is taken to be the correspondence induced by β if $i(\epsilon) \in V_\Gamma \setminus V_0$ (resp. $t(\epsilon) \in V_\Gamma \setminus V_0$) or the correspondence given by (2.3.2), if $i(\epsilon)$ (resp. $t(\epsilon)$) = z_e for some $e \in N^0$. The bottom map is then taken to be either the

connection map $\theta_{\beta(\epsilon)}$ if ϵ is horizontal, or the identity if ϵ is vertical.

This defines a connection $\theta^\sharp := \{\theta_\epsilon^\sharp\}_{\epsilon \in E^\sharp}$ on Γ^\sharp . Moreover with this connection the morphism of graphs β is actually a morphism of graph-connection pairs $\beta: (\Gamma^\sharp, \theta^\sharp) \rightarrow (\Gamma, \theta)$; this follows immediately from (2.3.3) and Definition 1.6.1.

In order to define a compatibility system for the pair $(\Gamma^\sharp, \theta^\sharp)$ which will support the desired (generalized) axial function, we need to assume that the sub-skeleton $(\Gamma_0, \alpha_0, \theta_0)$ is level. We have the following technical Lemma.

Lemma 2.3.4. *If the totally geodesic sub-skeleton $(\Gamma_0, \theta_0, \alpha_0)$ is level in the sense of Definition 1.3.6 then there exists a map*

$$n: N^0 \rightarrow \mathbb{R}_+$$

such that for every edge $e \in E_0$ and every edge $e' \in N_{i(e)}^0$ we have

$$\frac{n(e')}{n(\theta_e(e'))} = \lambda_e(e'). \quad (2.3.4)$$

Proof. Fix a base point $p \in V_0$. Let H denote the permutation sub-group of the set E_p consisting of holonomy maps K_γ for loops γ in Γ_0 based at p . Then the set N_p^0 is H -invariant, hence we can partition the normal edges at p into H -orbits:

$$N_p^0 = \bigsqcup_{c=1}^M N_p^0(c).$$

Fix representatives $e_p(c) \in N_p^0(c)$ for $1 \leq c \leq M$. Define $n(e_p(c)) := 1$ for $1 \leq c \leq M$. Using (2.3.4) we can extend n to all of N^0 as follows. Given $p' \in V_{\Gamma_0}$ distinct from p , fix $e' \in N_{p'}^0$. Let $\gamma \subset \Gamma_0$ be any path joining p to p' such that the path-connection map for γ gives $K_\gamma(e_p(c)) = e'$ for some $1 \leq c \leq M$. Note that while the path γ may not be unique, the representative $e_p(c)$ is unique. Define

$$n(e') := \frac{1}{|K_\gamma(e_p(c))|}.$$

The map

$$n: N^0 \rightarrow \mathbb{R}_+$$

is independent of the path γ since $(\Gamma_0, \alpha_0, \theta_0)$ is level; hence n is well-defined. Since

$$n(\theta_e(e')) = \frac{1}{|\theta_e \circ K_\gamma(e_p(c))|} = \frac{1}{\lambda_e(e')} \cdot \frac{1}{|K_\gamma(e_p(c))|},$$

we clearly have that $\frac{n(e')}{n(\theta_e(e'))} = \lambda_e(e')$ and this completes the proof of Lemma 2.3.4. \square

The map in Lemma 2.3.4 is called a *blow-up system* for Γ along Γ_0 . We assume for the rest of this section that the sub-skeleton $(\Gamma_0, \alpha_0, \theta_0)$ is level and we fix some choice of blow-up system $n: N^0 \rightarrow \mathbb{R}_+$.

We are now in a position to define λ^\sharp . Fix $\epsilon \in E^\sharp$. There are two cases to consider here.

For $\epsilon \in (E^\sharp)^v$ define

$$(E^\sharp_{i(\epsilon)})^v \xrightarrow{\lambda_\epsilon^\sharp} \mathbb{R}_+ \quad (2.3.5)$$

$$\overline{z_e z_{e'}} \longrightarrow \frac{n(e)}{n(e')}$$

where $\epsilon = \overline{z_e z_{e''}}$, and

$$(E^\sharp_{i(\epsilon)})^h \xrightarrow{\lambda_\epsilon^\sharp} \mathbb{R}_+ \quad (2.3.6)$$

$$\epsilon' \longrightarrow 1.$$

For $\epsilon \in (E^\sharp)^h$: On vertical edges $\epsilon' = \overline{z_e z_{e'}} \in (E^\sharp_{i(\epsilon)})^v$ define

$$\lambda_\epsilon^\sharp(\epsilon') = \lambda_{\beta(\epsilon)}(e) \cdot \lambda_{\beta(\epsilon)}(e'). \quad (2.3.7)$$

On horizontal edges define $\lambda_\epsilon^\sharp: (E^\sharp_{i(\epsilon)})^h \rightarrow \mathbb{R}_+$ so that the following diagram commutes:

$$\begin{array}{ccc} (E^\sharp_{i(\epsilon)})^h & \xrightarrow{\lambda_\epsilon^\sharp} & \mathbb{R}_+ \\ \beta \downarrow & \nearrow \lambda_{\beta(\epsilon)} & \\ E_{\beta(i(\epsilon))} & & \cdot \end{array} \quad (2.3.8)$$

Let us check that $\lambda^\sharp = \{\lambda_\epsilon^\sharp\}_{\epsilon \in E^\sharp}$ defines a compatibility system on the graph connection pair $(\Gamma^\sharp, \theta^\sharp)$. We must check that

$$\lambda_\epsilon^\sharp \circ \theta_\epsilon^\sharp = \frac{1}{\lambda_\epsilon^\sharp} \quad (2.3.9)$$

holds for all $\epsilon \in E^\sharp$.

Along vertical edges $\epsilon \in (E^\sharp)^v$:

- For each $\epsilon' \in (E_{i(\epsilon)}^\sharp)^h$ we have that $\theta_\epsilon^\sharp(\epsilon') \in (E_{i(\epsilon)}^\sharp)^h$, hence both sides of (2.3.9) evaluate to 1 on ϵ' by (2.3.6).

- For $\epsilon' \in (E_{i(\epsilon)}^\sharp)^v$, let $\epsilon = \overline{z_e z_{e'}}$ and $\epsilon' = \overline{z_{e'} z_{e''}}$. Then $\theta_\epsilon^\sharp(\overline{z_e z_{e'}}) = \overline{z_{e'} z_{e''}}$ by (2.3.3). Thus by (2.3.5), the LHS of (2.3.9) is $\lambda_\epsilon^\sharp(\overline{z_{e'} z_{e''}}) = \frac{n(e')}{n(\epsilon)}$ which is exactly the reciprocal of $\lambda_\epsilon^\sharp(\overline{z_e z_{e'}})$.

This shows that (2.3.9) holds for vertical ϵ .

Along horizontal edges $\epsilon \in (E^\sharp)^h$:

- For horizontal edges we have the following diagram:

$$\begin{array}{ccc} (E_{i(\epsilon)}^\sharp)^h & \xrightarrow{\theta_\epsilon^\sharp} & (E_{i(\epsilon)}^\sharp)^h & \xrightarrow{\lambda_\epsilon^\sharp} & \mathbb{R}_+ \\ \beta \downarrow & & \beta \downarrow & \nearrow \lambda_{\beta(\epsilon)} & \\ E_{\beta(i(\epsilon))} & \xrightarrow{\theta_{\beta(\epsilon)}} & E_{\beta(i(\epsilon))} & & \end{array} \quad (2.3.10)$$

This diagram is clearly commutative by (2.3.3) and (2.3.8). Thus it then follows that (2.3.9) holds along ϵ for horizontal edges, since the analogous identity holds for θ and λ along $\beta(\epsilon)$.

- For vertical edges $\epsilon' = \overline{z_e z_{e'}} \in (E_{i(\epsilon)}^\sharp)^v$ let $\overline{z_f z_{f'}} \in (E_{i(\bar{\epsilon})}^\sharp)^v$ denote the oriented edge $\theta_\epsilon^\sharp(\epsilon')$.

Then we have

$$\begin{aligned} \lambda_\epsilon^\sharp(\theta_\epsilon^\sharp(\epsilon')) &= \lambda_{\beta(\bar{\epsilon})}(f) \cdot \lambda_{\beta(\bar{\epsilon})}(f') \\ &= \frac{1}{\lambda_{\beta(\epsilon)}(e) \cdot \lambda_{\beta(\epsilon)}(e')} = \frac{1}{\lambda_\epsilon^\sharp(\epsilon')}. \end{aligned}$$

Thus (2.3.9) holds along ϵ for vertical edges as well.

We have defined a pre 1-skeleton $(\Gamma^\sharp, \theta^\sharp, \lambda^\sharp)$ called the *blow-up pre 1-skeleton* of $(\Gamma, \theta, \lambda)$. The following lemma shows that a generalized 1-skeleton structure on one

determines a generalized 1-skeleton structure on the other (almost).

Lemma 2.3.5. *Given a generalized axial function α for the pre 1-skeleton $(\Gamma, \theta, \lambda)$, there is a generalized axial function α^\sharp for the pre 1-skeleton $(\Gamma^\sharp, \theta^\sharp, \lambda^\sharp)$. Conversely, given a generalized axial function $\tilde{\alpha}$ for the pre 1-skeleton $(\Gamma^\sharp, \theta^\sharp, \lambda^\sharp)$ such that for all $e \in E_0$ and any two oriented edges $\epsilon, \epsilon' \in \beta^{-1}(e)$, $\tilde{\alpha}(\epsilon) = \tilde{\alpha}(\epsilon')$, there is a generalized axial function α for $(\Gamma, \theta, \lambda)$.*

Proof. Let $\alpha: E_\Gamma \rightarrow \mathbb{R}^n$ be a generalized axial function on $(\Gamma, \theta, \lambda)$. Define the function

$$\alpha^\sharp(\epsilon) = \begin{cases} \alpha(\beta(\epsilon)) & \text{if } \epsilon \in (E^\sharp)^h \\ n(e)\alpha(e') - n(e')\alpha(e) & \text{if } \epsilon = \overline{z_e z_{e'}} \in (E^\sharp)^v. \end{cases} \quad (2.3.11)$$

The function α^\sharp clearly satisfies gA1 in 2.2.8. We need only show that α^\sharp satisfies gA2.

Along vertical edges $\epsilon \in (E^\sharp)^v$:

- For $\epsilon' \in (E^\sharp_{i(\epsilon)})^h$ note that $\lambda_\epsilon^\sharp(\epsilon') = 1$. Also we have $\beta(\theta_\epsilon^\sharp(\epsilon')) = \beta(\epsilon')$ by (2.3.3). Hence $\alpha^\sharp(\epsilon') = \alpha(\beta(\epsilon)) = \alpha^\sharp(\theta_\epsilon^\sharp(\epsilon'))$.
- For $\epsilon' = \overline{z_e z_{e'}} \in (E^\sharp_{i(\epsilon)})^v$, we have $\lambda_\epsilon^\sharp(\epsilon') = \frac{n(e)}{n(e')}$ where $\epsilon = \overline{z_e z_{e''}}$. Furthermore we have $\theta_\epsilon^\sharp(\epsilon') = \overline{z_{e''} z_{e'}}$ and

$$\alpha^\sharp(\epsilon) = n(e)\alpha(e'') - n(e'')\alpha(e),$$

$$\alpha^\sharp(\epsilon') = n(e)\alpha(e') - n(e')\alpha(e)$$

and

$$\alpha^\sharp(\theta_\epsilon^\sharp(\epsilon')) = n(e'')\alpha(e') - n(e')\alpha(e'').$$

Hence in this case we have $\alpha^\sharp(\epsilon') - \lambda_\epsilon^\sharp(\epsilon')\alpha^\sharp(\theta_\epsilon^\sharp(\epsilon')) = \frac{n(e')}{n(e'')}\alpha^\sharp(\epsilon)$.

Along horizontal edges $\epsilon \in (E^\sharp)^h$:

- For $\epsilon' \in (E^\sharp_{i(\epsilon)})^h$, we have $\lambda_\epsilon^\sharp(\epsilon') = \lambda_{\beta(\epsilon)}(\beta(\epsilon'))$, $\beta(\theta_\epsilon^\sharp(\epsilon')) = \beta(\theta_{\beta(\epsilon)}(\beta(\epsilon')))$ and $\alpha^\sharp(\epsilon') =$

$\alpha(\beta(\epsilon'))$ on $(E^\sharp)^h$. Hence we have

$$\begin{aligned}\alpha^\sharp(\epsilon') - \lambda_\epsilon^\sharp(\epsilon')\alpha^\sharp(\theta_\epsilon^\sharp(\epsilon')) &= \alpha(\beta(\epsilon')) - \lambda_{\beta(\epsilon)}(\epsilon')\alpha(\theta_{\beta(\epsilon)}(\beta(\epsilon'))) \\ &= c \cdot \alpha(\beta(\epsilon)) = c \cdot \alpha^\sharp(\epsilon)\end{aligned}$$

for some $c \in \mathbb{R}$.

• For $\epsilon' = \overline{z_e z_{e'}} \in (E_{i(\epsilon)}^\sharp)^v$ we have $\theta_\epsilon^\sharp(\epsilon') = \overline{z_f z_{f'}}$ where $f = \theta_{\beta(\epsilon)}(e)$ and $f' = \theta_{\beta(\epsilon)}(e')$. Also $\lambda_\epsilon^\sharp(\epsilon') = \lambda_{\beta(\epsilon)}(e) \cdot \lambda_{\beta(\epsilon)}(e')$ by (2.3.7). We have

$$\alpha^\sharp(\epsilon) = \alpha(\beta(\epsilon)),$$

$$\alpha^\sharp(\epsilon') = n(e)\alpha(e') - n(e')\alpha(e),$$

and

$$\alpha^\sharp(\theta_\epsilon^\sharp(\epsilon')) = n(f)\alpha(f') - n(f')\alpha(f).$$

Here is where we use condition 2.3.4 in Lemma 2.3.4. The point is that $\frac{n(e)}{n(f)} = \lambda_{\beta(\epsilon)}(e)$ and $\frac{n(e')}{n(f')} = \lambda_{\beta(\epsilon)}(e')$. Hence we have

$$\begin{aligned}\alpha^\sharp(\epsilon') - \lambda_\epsilon^\sharp(\epsilon')\alpha^\sharp(\theta_\epsilon^\sharp(\epsilon')) &= \\ n(e)\alpha(e') - n(e')\alpha(e) - \lambda_{\beta(\epsilon)}(e) \cdot \lambda_{\beta(\epsilon)}(e') (n(f)\alpha(f') - n(f')\alpha(f)) &= \\ n(e)\alpha(e') - n(e')\alpha(e) - \frac{n(e)}{n(f)} \frac{n(e')}{n(f')} (n(f)\alpha(f') - n(f')\alpha(f)) &= \\ n(e) \left(\alpha(e') - \lambda_{\beta(\epsilon)}(e')\alpha(f') \right) - n(e') \left(\alpha(e) - \lambda_{\beta(\epsilon)}(e)\alpha(f) \right) &= c\alpha(\beta(\epsilon)) = c\alpha^\sharp(\epsilon)\end{aligned}$$

for some $c \in \mathbb{R}$.

This shows that α^\sharp is a generalized axial function for the pre 1-skeleton $(\Gamma^\sharp, \theta^\sharp, \lambda^\sharp)$.

Now assume that $\tilde{\alpha}: E^\sharp \rightarrow \mathbb{R}^n$ is a generalized axial function for the pre 1-skeleton $(\Gamma^\sharp, \theta^\sharp, \lambda^\sharp)$ with the property that for every $e \in E_0$ and every pair $\epsilon, \epsilon' \in \beta^{-1}(e)$, $\tilde{\alpha}(\epsilon) = \tilde{\alpha}(\epsilon')$. Then define the function $\alpha: E_\Gamma \rightarrow \mathbb{R}^n$

$$\alpha(e) = \tilde{\alpha}(\epsilon) \tag{2.3.12}$$

where $\epsilon \in \beta^{-1}(e)$. Note that the fiber $\beta^{-1}(e)$ consists only of horizontal edges of the blow-up. Moreover $\beta^{-1}(e)$ consists of a single edge unless $e \in E_0$. Hence α is well defined (we are assuming $\tilde{\alpha}$ is constant on the non-trivial fibers $\beta^{-1}(e)$). We verify that α is a generalized axial function on the pre 1-skeleton $(\Gamma, \theta, \lambda)$.

By (2.3.8) we have that $\lambda_\epsilon^\sharp(\epsilon') = \lambda_{\beta(\epsilon)}(\beta(\epsilon'))$ for all $\epsilon, \epsilon' \in (E_x^\sharp)^h$, $x \in V^\sharp$. Fix $e \in E_\Gamma$ and $\epsilon \in \beta^{-1}(e)$. The important point is that $\beta: (E_{i(\epsilon)}^\sharp)^h \rightarrow E_{\beta(i(\epsilon))}$ is a bijection and by (2.3.3) we have that $\theta_e(e') = \theta_\epsilon^\sharp(\epsilon')$ where $\epsilon' \in (E_{i(\epsilon)}^\sharp)^h$ is the unique oriented edge such that $\beta(\epsilon') = e'$. It then follows that

$$\alpha(e') - \lambda_e(e')\alpha(\theta_e(e')) = \tilde{\alpha}(\epsilon') - \lambda_\epsilon^\sharp\tilde{\alpha}(\theta_\epsilon^\sharp(\epsilon')) = c \cdot \tilde{\alpha}(\epsilon) = c \cdot \alpha(e).$$

This shows that α is a generalized axial function for $(\Gamma, \theta, \lambda)$, and hence completes the proof of Lemma 2.3.5. \square

Definition 2.3.6. $(\Gamma^\sharp, \alpha^\sharp, \theta^\sharp, \lambda^\sharp)$ is called the blow-up of Γ along Γ_0 .

If α^\sharp is 2-independent, then $(\Gamma^\sharp, \alpha^\sharp, \theta^\sharp, \lambda^\sharp)$ is a 1-skeleton with connection in the sense of Definition 1.1.3, with compatibility system λ^\sharp .

If we set $\beta_L: \mathbb{R}^n \rightarrow \mathbb{R}^n$ to be the identity map on \mathbb{R}^n and set $\beta_G := \beta$ then we get a morphism of 1-skeleta with connection which we denote by the symbol β again

$$\beta = (\beta_G, \beta_L): (\Gamma^\sharp, \alpha^\sharp, \theta^\sharp) \rightarrow (\Gamma, \alpha, \theta).$$

It turns out that the morphism of 1-skeleta with connection

$$\beta_0: (\Gamma_0^\sharp, \alpha_0^\sharp, \theta_0^\sharp) \rightarrow (\Gamma_0, \alpha_0, \theta_0)$$

is actually a fiber bundle of 1-skeleta with connection.

Remark. *Guillemin and Zara introduced this beautiful construction and used it to great effect in their paper [14]. Their set of assumptions however are a bit more restrictive than those we make here. In particular they assume that*

1. α is 3-independent and
2. the compatibility constants along edges of Γ_0 for the normal edges are all equal to 1;
i.e. $\lambda_e(e') = 1$ for $e \in E_0$ and $e' \in N_{i(e)}^0$.

Note that if 2. holds then $(\Gamma_0, \alpha_0, \theta_0)$ is level and if 1. holds, the function α^\sharp is indeed an axial function for the pair $(\Gamma^\sharp, \theta^\sharp)$.

2.4 The Main Result

Definition 2.4.1. We say that the d -valent generalized 1-skeleton $(\Gamma, \alpha, \theta, \lambda) \subset \mathbb{R}^n$ admits a lift if there exists a generalized axial function $A: E_\Gamma \rightarrow \mathbb{R}^d$ for the pre 1-skeleton $(\Gamma, \theta, \lambda)$ that satisfies the following conditions

- L1. $\{A(e) \mid e \in E_p\}$ is a basis for \mathbb{R}^d for each $p \in V_\Gamma$
- L2. there is a surjective linear map $p: \mathbb{R}^d \rightarrow \mathbb{R}^n$ such that $\alpha = p \circ A$.

We call the generalized 1-skeleton $(\Gamma, A, \theta, \lambda) \subset \mathbb{R}^d$ a lift of $(\Gamma, \alpha, \theta, \lambda) \subset \mathbb{R}^n$.

We now come to the main result of this chapter. Let $(\Gamma, \alpha, \theta, \lambda) \subset \mathbb{R}^n$ be a d -valent 1-skeleton.

Theorem 2.4.2. The following are equivalent:

- i. $(\Gamma, \alpha, \theta, \lambda)$ has a non-cyclic lift
- ii. $(\Gamma, \alpha, \theta, \lambda)$ is reducible and for every regular value $c \in \mathbb{R}$, we have $(\Gamma_c, \alpha_c^u, \theta_c^u, \lambda_c^u) \equiv (\Gamma_c, \alpha_c^d, \theta_c^d, \lambda_c^d)$.
- iii. $(\Gamma, \alpha, \theta, \lambda)$ is reducible and every 2 face is level and has trivial normal holonomy.

The argument used to prove Theorem 2.4.2 runs as follows. First we prove the equivalence of (ii) and (iii) which is relatively straightforward. That (i) implies (ii) is also straightforward. The direction that requires the most work is showing that (ii) implies (i). To this end we first show that (ii) implies that every c -cross-section has a lift. Next we show that if $(\Gamma, \alpha, \theta, \lambda) \subset \mathbb{R}^n$ satisfies (ii), then so does the direct product (or the tilted product) of $(\Gamma, \alpha, \theta, \lambda)$ with an interval (we will find the characterization in (iii) useful here). We then show that $(\Gamma, \alpha, \theta, \lambda)$ is equivalent to a cross-section of this tilted product 1-skeleton which satisfies (ii), hence has a lift. That the lift is non-cyclic will follow from the reducibility condition on $(\Gamma, \alpha, \theta, \lambda)$. The remainder of this section will be devoted to the proof of Theorem 2.4.2.

2.4.1 The Easy Part

Fix a d -valent reducible 1-skeleton $(\Gamma, \alpha, \theta, \lambda) \subset \mathbb{R}^n$, a polarizing covector $\xi \in (\mathbb{R}^n)^*$ and a ξ -compatible Morse function $\phi: V_\Gamma \rightarrow \mathbb{R}$. Fix a ϕ -regular value $c \in \mathbb{R}$, and let $Q \in E_c$ be as before with $i(Q) = \overline{pq}$, $t(Q) = \overline{vw}$, $\gamma_Q^\mu: q = r_1 \rightarrow r_2 \rightarrow \cdots \rightarrow r_k = w$ and $\gamma_Q^d: p \rightarrow t_1 \rightarrow \cdots \rightarrow t_m = v$. First we need a lemma.

Lemma 2.4.3. *Let $\kappa: E_c \rightarrow \mathbb{R}_+$ be the function defined by $\kappa(Q) := \lambda_{\overline{qp}}(\overline{qr_2})$. Then $\alpha_c^\mu = \kappa \cdot \alpha_c^d$.*

Proof. First observe that the subspaces W_ξ and $\langle \alpha(\overline{pq}) \rangle$ are situated transversely in \mathbb{R}^n .

We have that

$$\alpha_c^d(Q) = \alpha(\overline{pt_2}) - \frac{\langle \xi, \alpha(\overline{pt_2}) \rangle}{\langle \xi, \alpha(\overline{pq}) \rangle} \alpha(\overline{pq}) \in W_\xi$$

and

$$\alpha_c^\mu(Q) = \alpha(\overline{qr_2}) - \frac{\langle \xi, \alpha(\overline{qr_2}) \rangle}{\langle \xi, \alpha(\overline{qp}) \rangle} \alpha(\overline{qp}) \in W_\xi.$$

Since $\alpha(\overline{qr_2}) - \lambda_{\overline{qp}}(\overline{qr_2})\alpha(\overline{qp}) \in \langle \alpha(\overline{qp}) \rangle$, we have that

$$\alpha_c^\mu(Q) - \kappa(Q)\alpha_c^d(Q) \in W_\xi \cap \langle \xi, \alpha(\overline{pq}) \rangle.$$

Thus we must have $\alpha_c^u = \kappa \cdot \alpha_c^d$. □

(ii) \Leftrightarrow (iii)

Lemma 2.4.3 implies that the c -cross-sections $(\Gamma_c, \alpha_c^u, \theta_c^u, \lambda_c^u)$ and $(\Gamma_c, \alpha_c^d, \theta_c^d, \lambda_c^d)$ are equivalent if and only if $\theta_c^u = \theta_c^d$ and $\lambda_c^u = \frac{\kappa}{\kappa \circ \theta_c^u} \cdot \lambda_c^d$.

Identify $(E_c)_{\overline{pq}} \setminus \{Q\} \cong N_p^0 \cong N_q^0$ and $(E_c)_{\overline{vw}} \setminus \{\bar{Q}\} \cong N_v^0 \cong N_w^0$. Consider the following diagram:

$$\begin{array}{ccc}
 (E_c)_{\overline{pq}} \setminus \{Q\} & \xrightarrow{(\theta_c^u)_Q} & (E_c)_{\overline{vw}} \setminus \{\bar{Q}\} \\
 \cong \downarrow & & \cong \downarrow \\
 N_q^0 & \xrightarrow{K_{\gamma_Q^u}^\perp} & N_w^0 \\
 \theta_{\overline{qp}}^\perp \downarrow & & \theta_{\overline{vw}}^\perp \downarrow \\
 N_p^0 & \xrightarrow{K_{\gamma_Q^d}^\perp} & N_v^0 \\
 \cong \downarrow & & \cong \downarrow \\
 (E_c)_{\overline{pq}} \setminus \{Q\} & \xrightarrow{(\theta_c^d)_Q} & (E_c)_{\overline{vw}} \setminus \{\bar{Q}\}.
 \end{array}$$

Note that the top and bottom squares commute by the definition of θ_c^u and θ_c^d respectively. Also note that the long vertical maps on the left and right sides are the identity maps on the sets $(E_c)_{\overline{pq}} \setminus \{Q\}$ and $(E_c)_{\overline{vw}} \setminus \{\bar{Q}\}$ respectively. Then $(\theta_c^u)_Q = (\theta_c^d)_Q$ if and only if the middle square commutes which is equivalent to saying that the 2-face Q has trivial normal holonomy.

Now let $R \in (E_c)_{\overline{pq}} \setminus \{Q\}$ and suppose it corresponds to oriented edges $\overline{qu_1} \in N_q^0$ and $\overline{ps_1} \in N_p^0$. Then

$$(\lambda_c^u)_Q(R) = \frac{\kappa(R)}{\kappa((\theta_c^u)_Q(R))} (\lambda_c^d)_Q(R) \tag{2.4.1}$$

if and only if

$$|K_{\gamma_Q^u}(\overline{qu_1})| = \frac{\lambda_{\overline{qp}}(\overline{qu_1})}{\lambda_{\overline{vw}}(K_{\gamma_Q^u}^\perp(\overline{qu_1}))} \cdot |K_{\gamma_Q^d}(\overline{ps_1})|. \tag{2.4.2}$$

Note that $\lambda_{\overline{wv}}(K_{\gamma_Q}^\perp(qu_1)) \cdot |K_{\gamma_Q^u}(\overline{qu_1})| = |K_{\gamma_1}(\overline{qu_1})|$, where $\gamma_1: q \rightarrow r_2 \rightarrow \cdots \rightarrow w \rightarrow v$. Also note that $\lambda_{\overline{qp}}(\overline{qu_1}) \cdot |K_{\gamma_Q^d}(\overline{ps_1})| = |K_{\gamma_2}(\overline{qu_1})|$, where $\gamma_2: q \rightarrow p \rightarrow t_2 \rightarrow \cdots \rightarrow v$. Therefore (2.4.2) holds for every $\overline{qu_1} \in N_q^0$ if and only if $|K_{\gamma_1}(\overline{qu_1})| = |K_{\gamma_2}(\overline{qu_1})|$ for every $\overline{qu_1} \in N_q^0$. But this holds if and only if the 2-face Q is level.

This shows that (ii) and (iii) are equivalent.

(i) \Rightarrow (ii)

Let $(\Gamma, A, \theta, \lambda) \subset \mathbb{R}^d$ be a lift of $(\Gamma, \alpha, \theta, \lambda) \subset \mathbb{R}^n$ with respect to a projection map $p: \mathbb{R}^d \rightarrow \mathbb{R}^n$. Let $p^*: (\mathbb{R}^n)^* \rightarrow (\mathbb{R}^d)^*$ be the dual of p . Then the covector $\tilde{\xi} := p^*(\xi)$ is a polarizing covector for $(\Gamma, A, \theta, \lambda)$. Indeed we have for every $e \in E_\Gamma$, $\langle p^*(\xi), A(e) \rangle = \langle \xi, p \circ A(e) \rangle = \langle \xi, \alpha(e) \rangle$. Thus ϕ is also a $\tilde{\xi}$ -compatible Morse function for $(\Gamma, A, \theta, \lambda)$.

Let $c \in \mathbb{R}$ be any ϕ -regular value. Then since A is d -independent, it follows that A_c^u and A_c^d are $(d-1)$ -independent. By Lemma 2.4.3, we have $A_c^u = \kappa \cdot A_c^d$, hence we must also have $\alpha_c^u = \kappa \cdot \alpha_c^d$. By the independence conditions on A_c^u, A_c^d (all we need is 2-independence here) we are forced to have $\theta_c^u = \theta_c^d$ and $\lambda_c^u = \frac{\kappa}{\kappa \circ \theta_c^d} \cdot \lambda_c^d$. Hence we have $(\Gamma_c, A_c^u, \theta_c^u, \lambda_c^u) \equiv (\Gamma_c, A_c^d, \theta_c^d, \lambda_c^d)$ and therefore also have $(\Gamma_c, \alpha_c^u, \theta_c^u, \lambda_c^u) \equiv (\Gamma_c, \alpha_c^d, \theta_c^d, \lambda_c^d)$.

This shows that (i) implies (ii).

2.4.2 Lifting Cross-Sections

Let $(\Gamma, \alpha, \theta, \lambda)$ be a d -valent generalized 1-skeleton with connection, $(\Gamma_0, \alpha_0, \theta_0, \lambda_0)$ a k -valent totally geodesic, level sub-skeleton and let $n: N^0 \rightarrow \mathbb{R}_+$ be a compatible blow-up system. Let $(\Gamma^\#, \alpha^\#, \theta^\#, \lambda^\#)$ denote the corresponding blow-up generalized 1-skeleton with connection. The following lemma is a cornerstone in the proof of Theorem 2.4.2.

Lemma 2.4.4. *If $(\Gamma, A, \theta, \lambda) \subset \mathbb{R}^d$ is a lift of $(\Gamma, \alpha, \theta, \lambda) \subset \mathbb{R}^n$, then $(\Gamma^\#, A^\#, \theta^\#, \lambda^\#) \subset \mathbb{R}^d$ is a lift of $(\Gamma^\#, \alpha^\#, \theta^\#, \lambda^\#) \subset \mathbb{R}^n$. Conversely if $(\Gamma^\#, \tilde{A}, \theta^\#, \lambda^\#)$ is a lift of $(\Gamma^\#, \alpha^\#, \theta^\#, \lambda^\#)$, then*

$\tilde{A} = A^\#$ where $(\Gamma, A, \theta, \lambda)$ is a lift of $(\Gamma, \alpha, \theta, \lambda)$.

Proof. Let $(\Gamma, A, \theta, \lambda) \subset \mathbb{R}^d$ be a lift of $(\Gamma, \alpha, \theta, \lambda) \subset \mathbb{R}^n$ via a projection map $p: \mathbb{R}^d \rightarrow \mathbb{R}^n$. Then by Lemma 2.3.5 there is a generalized axial function $A^\#$ for the pre 1-skeleton $(\Gamma^\#, \theta^\#, \lambda^\#)$ defined by (4.3.2). The axial function $\alpha^\#$ is also defined according to (4.3.2), hence we must have $p \circ A^\# = \alpha^\#$. Since A is d -independent and $\{A^\#(\epsilon) \mid \epsilon \in E_x^\#\} = \{A(\beta(\epsilon)) \mid \beta(\epsilon) \in E_{\beta(x)}\}$ for all $x \in V_\Gamma \setminus V_{\Gamma_0}$, $A^\#$ must also be d -independent. Therefore $(\Gamma^\#, A^\#, \theta^\#, \lambda^\#)$ must be a lift of $(\Gamma^\#, \alpha^\#, \theta^\#, \lambda^\#)$.

Conversely suppose that $(\Gamma^\#, \tilde{A}, \theta^\#, \lambda^\#)$ is a lift of $(\Gamma^\#, \alpha^\#, \theta^\#, \lambda^\#)$ via the projection map $p: \mathbb{R}^d \rightarrow \mathbb{R}^n$. First we check that $\tilde{A}(\epsilon) = \tilde{A}(\epsilon')$ for all $\epsilon, \epsilon' \in \beta^{-1}(e)$, $e \in E_0$. Since the fibers of β are connected, it suffices to check this in the case where $i(\epsilon)$ and $i(\epsilon')$ are joined by an oriented edge $\epsilon'' \in (E^\#)^\vee$. In this case we have

$$\tilde{A}(\epsilon) - \lambda_{\epsilon'',(\epsilon)}^\# \tilde{A}(\epsilon') = c \tilde{A}(\epsilon'') \quad (2.4.3)$$

for some $c \in \mathbb{R}$. The claim is that $c = 0$. To see this, apply the projection p to both sides of (2.4.3) to get

$$\alpha^\#(\epsilon) - \lambda_{\epsilon'',(\epsilon)}^\# \alpha^\#(\epsilon') = c \alpha^\#(\epsilon''); \quad (2.4.4)$$

On the other hand, recall that $\lambda_{\epsilon'',(\epsilon)}^\# = 1$ and $\alpha^\#(\epsilon) = \alpha^\#(\epsilon')$. Thus the LHS of (2.4.4) must be zero, which implies that c must also be zero.

Thus we can apply Lemma 2.3.5 to get a generalized axial function A on $(\Gamma, \theta, \lambda)$ defined by (2.3.12). Clearly $p \circ A = \alpha$, using $p \circ \tilde{A} = \alpha^\#$ and (2.3.12). Finally that A is d -independent follows from (2.3.12) and from the fact that $A^\#$ is d -independent. This completes the proof of Lemma 2.4.4. \square

In [14] Guillemin and Zara explicitly describe the changes in the cross-section in passing over a critical value in the 3-independent non-cyclic case. Essentially they show that two consecutive cross-sections can be blown-up to equivalent 1-skeleta. With a

little more effort one can show that their results continue to hold in the general case (i.e. replace “3-independent non-cyclic” with “reducible” and replace “1-skeleta” with “generalized 1-skeleta”). Here are the details.

Let $(\Gamma, \alpha, \theta, \lambda) \subset \mathbb{R}^n$ be a d -valent 1-skeleton satisfying (ii). Fix a polarizing covector $\xi \in (\mathbb{R}^n)^*$ and a ξ -compatible Morse function.

Let $c < c'$ be two consecutive ϕ -regular values in the sense that there is a unique vertex $p \in V_\Gamma$ such that $c < \phi(p) < c'$. Suppose that $\text{ind}_\xi(p) = r$ and let

$$\{\overline{p_i p} \mid 1 \leq i \leq r\}$$

be those edges flowing into p (i.e. $\langle \xi, \alpha(\overline{p_i p}) \rangle > 0$ for $1 \leq i \leq r$) and let

$$\{\overline{p q_a} \mid 1 \leq a \leq d - r\}$$

be those edges flowing out from p (i.e. $\langle \xi, \alpha(\overline{p q_a}) \rangle > 0$ for $1 \leq a \leq (d - r)$).

Consider the up c -cross section $(\Gamma_c, \alpha_c^u, \theta_c^u, \lambda_c^u)$. The set of oriented edges

$$\{\overline{p_i p} \mid 1 \leq i \leq r\} := V_c^0 \subset V_c$$

is the vertex set of a totally geodesic, complete subgraph $\Gamma_{0,c} \subset \Gamma_c$. Let $Q_{ia} \in \mathcal{F}_2$ denote the oriented 2-face spanned by oriented edges $\overline{p p_i}, \overline{p q_a} \in E_p$ such that $i(Q_{ia}) = \overline{p_i p}$. The set of oriented edges in Γ_c that are normal to $\Gamma_{c,0}$ is denoted by

$$N_c^0 := \{Q_{ia} \mid 1 \leq a \leq (d - r) \ 1 \leq i \leq r\}.$$

Define the function

$$n^u : N^0 \rightarrow \mathbb{R}_+$$

by

$$n^u(Q_{ia}) := \langle \xi, \alpha(\overline{p q_a}) \rangle. \quad (2.4.5)$$

The up-connection gives

$$(\theta_c^u)_{Q_{ij}}(Q_{ia}) = Q_{ja} \quad (2.4.6)$$

and up-compatibility system gives

$$(\lambda_c^u)_{Q_{ij}}(Q_{ia}) = 1 \quad (2.4.7)$$

for all i, j, a . In particular we see that n^u defines a blow-up system for Γ_c along $\Gamma_{0,c}$. Denote the corresponding blow-up generalized 1-skeleton by

$$(\Gamma_c^\#, (\alpha_c^u)^\#, (\theta_c^u)^\#, (\lambda_c^u)^\#).$$

Next consider the down c' -cross section $(\Gamma_{c'}, \alpha_{c'}^d, \theta_{c'}^d, \lambda_{c'}^d)$. The set of oriented edges

$$\{\overline{pq_a} \mid 1 \leq a \leq d-r\} := V_{c'}^0 \subset V_{c'}$$

is the vertex set of a totally geodesic, complete subgraph $\Gamma_{0,c'} \subset \Gamma_{c'}$. Let $Q_{ai} \in \mathcal{F}_2$ denote the oriented 2-face spanned by oriented edges $\overline{pp_i}, \overline{pq_a} \in E_p$ such that $i(Q_{ai}) = \overline{pq_a}$. The set of oriented edges in $\Gamma_{c'}$ that are normal to $\Gamma_{c',0}$ is denoted by

$$N_{c'}^0 := \{Q_{ai} \mid 1 \leq i \leq r \ 1 \leq a \leq (d-r)\}.$$

Define the function

$$n^d: N^0 \rightarrow \mathbb{R}_+$$

by

$$n^d(Q_{ai}) := \langle \xi, \alpha(\overline{pp_i}) \rangle. \quad (2.4.8)$$

The down-connection gives

$$(\theta_{c'}^d)_{Q_{ab}}(Q_{ai}) = Q_{bi} \quad (2.4.9)$$

and the down-compatibility system gives

$$(\lambda_{c'}^d)_{Q_{ab}}(Q_{ai}) = 1 \quad (2.4.10)$$

for all a, b, i . In particular n^d defines a blow-up system for $\Gamma_{c'}$ along $\Gamma_{0,c'}$. Denote the corresponding blow-up generalized 1-skeleton by

$$(\Gamma_{c'}^\#, (\alpha_{c'}^d)^\#, (\theta_{c'}^d)^\#, (\lambda_{c'}^d)^\#).$$

We have attempted to illustrate the situation in Figure 21.

The following lemma is an analogue of Theorem 2.3.2 in [14].

Lemma 2.4.5. $(\Gamma_c^\#, (\alpha_c^u)^\#, (\theta_c^u)^\#, (\lambda_c^u)^\#) \equiv (\Gamma_{c'}^\#, (\alpha_{c'}^d)^\#, (\theta_{c'}^d)^\#, (\lambda_{c'}^d)^\#)$

Proof. Let β_c and $\beta_{c'}$ denote the blow-down morphisms for the up c -cross section and the down c' -cross section, respectively. We have that

$$V_c^\# = V_c \setminus V_c^0 \sqcup N_c^0$$

and

$$V_{c'}^\# = V_{c'} \setminus V_{c'}^0 \sqcup N_{c'}^0.$$

The sets $V_c \setminus V_c^0$ and $V_{c'} \setminus V_{c'}^0$ are naturally identified: if an oriented edge $e \in E_\Gamma$ does not contain p and crosses the c -level, then it must also cross the c' -level.

The sets N_c^0 and $N_{c'}^0$ are also naturally identified by the identification

$$Q_{ia} \equiv Q_{ai}.$$

There are four types of edges in $\Gamma_c^\#$:

1. $R \in E_c \setminus \{E_{c,0}^\# \cup N_c^0\}$
2. $Q_{ia} \in N_c^0$
3. $\overline{Q_{ia}Q_{ib}} \ a \neq b$ (vertical in $\Gamma_{c,0}^\#$)
4. $\overline{Q_{ia}Q_{ja}} \ i \neq j$ (horizontal in $\Gamma_{c,0}^\#$)

This identification $V_c^\# \cong V_{c'}^\#$ induces an identification of graphs $\Gamma_c \xrightarrow{\cong} \Gamma_{c'}$ such

that

$$\begin{aligned}
R &\cong R \\
Q_{ia} &\cong Q_{ai} \\
\overline{Q_{ia}Q_{ib}} &\cong \overline{Q_{ai}Q_{bi}} \\
\overline{Q_{ia}Q_{ja}} &\cong \overline{Q_{ai}Q_{aj}}
\end{aligned} \tag{2.4.11}$$

Note that the horizontal edges in $\Gamma_{c,0}^\sharp$ are identified with the vertical edges in $\Gamma_{c',0}^\sharp$ and vice-versa.

We would like to show that $(\theta_c^u)^\sharp = (\theta_{c'}^d)^\sharp$ under this identification of Γ_c^\sharp and $\Gamma_{c'}^\sharp$. First we check that these maps agree along oriented edges in the singular locus. Fix an oriented edge $\epsilon \in (E_{c,0}^\sharp)$. We can identify the oriented edges $(E_c)_{\beta_c(i(\epsilon))}$ and $(E_{c'})_{\beta_{c'}(i(\epsilon))}$ as follows. Suppose that $\beta_c(i(\epsilon)) = \overline{p_i p}$ and that $\beta_{c'}(i(\epsilon)) = \overline{p q_a}$. Then identify

$$\begin{array}{ccc}
(E_c)_{\beta_c(i(\epsilon))} & \xrightarrow{\Psi} & (E_{c'})_{\beta_{c'}(i(\epsilon))} \\
Q_{ib} & \longrightarrow & Q_{ab} \\
Q_{ia} & \longrightarrow & Q_{ai} \\
Q_{ij} & \longrightarrow & Q_{aj}
\end{array}$$

For notational convenience, set $x = i(\epsilon)$ and $y = t(\epsilon)$. Let

$$(\hat{E}_c)_{\beta_c(x)} := (E_c)_{\beta_c(x)} \setminus \{Q_{ia}\}$$

and

$$(\hat{E}_{c'})_{\beta_{c'}(x)} := (E_{c'})_{\beta_{c'}(x)} \setminus \{Q_{ai}\}.$$

We have the following diagram:

$$\begin{array}{ccc}
(E_{c,0}^\#)_x & \xrightarrow{(\theta_c^\#)_\epsilon} & (E_{c,0}^\#)_y \\
\psi \searrow & & \swarrow \psi \\
& (\hat{E}_c)_{\beta_c(x)} \xrightarrow{\cong} (\hat{E}_c)_{\beta_c(y)} & \\
\Psi \downarrow & & \downarrow \Psi \\
& (\hat{E}_{c'})_{\beta_{c'}(x)} \xrightarrow{\cong} (\hat{E}_{c'})_{\beta_{c'}(y)} & \\
\psi \swarrow & & \nwarrow \psi \\
(E_{c',0}^\#)_x & \xrightarrow{(\theta_{c'}^\#)_\epsilon} & (E_{c',0}^\#)_y
\end{array} \quad (2.4.12)$$

The diagonal maps are the identifications as in (2.3.2). The short horizontal maps are taken to be either the identity if ϵ is vertical or $\theta_{\beta(\epsilon)}$ if ϵ is horizontal. The long vertical maps are the identifications in (2.4.11) above. We want to show that the outer rectangle commutes.

Note that the upper and lower quadrilaterals in (2.4.12) commute by definition of the blow-up connection, as in (2.3.3). It is straightforward to check that the left and right quadrilaterals in (2.4.12) commute:

$$\begin{aligned}
\Psi \circ \psi(\epsilon) &= \begin{cases} \Psi(Q_{ib}) & \text{if } \epsilon = \overline{Q_{ia}Q_{ib}} \\ \Psi(Q_{ij}) & \text{if } \epsilon = \overline{Q_{ia}Q_{ja}} \end{cases} \\
&= \begin{cases} Q_{ab} & \text{if } \epsilon = \overline{Q_{ia}Q_{ib}} \\ Q_{aj} & \text{if } \epsilon = \overline{Q_{ia}Q_{ja}} \end{cases} \\
&\cong \psi(\epsilon).
\end{aligned}$$

Moreover one can check that the middle rectangle commutes as well. In this case note that if $\epsilon \in (E_{c,0}^\#)^h$ then $\epsilon \in (E_{c',0}^\#)^v$. By symmetry we may assume that $\epsilon = \overline{Q_{ia}Q_{ja}} \in (E_{c,0}^\#)^h$. Then checking the commutativity of the middle rectangle in (2.4.12) amounts to

checking the commutativity of the following diagram:

$$\begin{array}{ccc}
 (\hat{E}_c)_{\beta_c(x)} & \xrightarrow{(\theta_c^u)_{\beta(\epsilon)}} & (\hat{E}_c)_{\beta_c(y)} \\
 \Psi \downarrow & & \downarrow \Psi \\
 (\hat{E}_{c'})_{\beta_{c'}(x)} & \xrightarrow{=} & (\hat{E}_{c'})_{\beta_{c'}(y)}.
 \end{array}$$

We compute

$$\begin{aligned}
 \Psi \circ (\theta_{c'}^u)_{\beta_{c'}(\epsilon)}(e') &= \begin{cases} \Psi(Q_{jb}) & \text{if } e' = Q_{ib} \\ \Psi(Q_{jk}) & \text{if } e' = Q_{ik} \end{cases} \\
 &= \begin{cases} Q_{ab} & \text{if } e' = Q_{ib} \\ Q_{ak} & \text{if } e' = Q_{ik} \end{cases} \\
 &= \Psi(e').
 \end{aligned}$$

This shows that the middle rectangle in (2.4.12) commutes. Therefore the outer rectangle in (2.4.12) must also commute. Thus we have $(\theta_c^u)^\# = (\theta_{c'}^d)^\#$ along the singular locus under the identification of the singular loci $\Gamma_{c,0}^\# \xrightarrow{\cong} \Gamma_{c',0}^\#$ in (2.4.11).

To see that these two connections agree outside of the singular locus, we need the 2-faces at the c -level to have trivial normal holonomy, which holds since $(\Gamma, \alpha, \theta, \lambda)$ satisfies (ii) (which we showed is equivalent to (iii)).

It is straightforward to see that for oriented edges $\epsilon \in E_c^\#$ disjoint from the singular locus, $(\theta_c^u)^\#_\epsilon = (\theta_{c'}^d)^\#_\epsilon$. Indeed such oriented edges correspond to oriented 2-faces R at the c -level that do not contain the vertex p . Hence R is also at the c' level and in this case $(\theta_c^u)^\#_R = (\theta_c^u)_R$ and $(\theta_{c'}^d)^\#_R = (\theta_{c'}^d)_R$. Moreover there is a natural identification of $(\theta_{c'}^d)_R$ with $(\theta_c^d)_R$. Since R has trivial normal holonomy, it follows that $(\theta_c^u)_R = (\theta_c^d)_R$. We leave it as an exercise to verify that $(\theta_c^u)^\#$ agrees with $(\theta_{c'}^d)^\#$ along the oriented edges normal to the singular locus $\epsilon \in \beta_c^{-1}(N_c^0)$.

Hence we actually have an identification of graph connection pairs

$$(\Gamma_c^\sharp, (\theta_c^u)^\sharp) \cong (\Gamma_{c'}^\sharp, (\theta_{c'}^d)^\sharp).$$

We will now show that this extends to an equivalence of generalized 1-skeleta.

Define the function

$$\begin{aligned} E_c^\sharp &\equiv E_{c'}^\sharp \xrightarrow{\kappa} \mathbb{R}_+ & (2.4.13) \\ R &\xrightarrow{\quad} \lambda_{\overline{qp}}(qr) \\ Q_{ia} &\xrightarrow{\quad} \frac{\langle \xi, \alpha(\overline{pq}_a) \rangle}{\langle \xi, \alpha(\overline{p_i p}) \rangle} \\ \overline{Q_{ia} Q_{ib}} &\xrightarrow{\quad} \langle \xi, \alpha(\overline{pq}_a) \rangle \\ \overline{Q_{ia} Q_{ja}} &\xrightarrow{\quad} \frac{1}{\langle \xi, \alpha(\overline{p_i p}) \rangle} \end{aligned}$$

where $R = \{p \rightarrow q \rightarrow r \rightarrow \dots\}$. We need to check that $(\alpha_c^u)^\sharp = \kappa \cdot (\alpha_{c'}^d)^\sharp$ and that $(\lambda_c^u)^\sharp_\epsilon = \frac{\kappa}{\kappa \circ (\theta_c^u)^\sharp_\epsilon} \cdot (\lambda_{c'}^d)^\sharp_\epsilon$ for all $\epsilon \in E_c^\sharp \equiv E_{c'}^\sharp$ as in Definition 2.2.10.

• For edges $R \in E_c^\sharp \equiv E_{c'}^\sharp$ of type 1:

Then R is an oriented 2-face of $(\Gamma, \alpha, \theta, \lambda)$ that does not contain the vertex p . Also we have that $\alpha_{c'}^d(R) = \alpha_c^d(R)$. Thus by Lemma 2.4.3 we have

$$(\alpha_c^u)^\sharp(R) = \alpha_c^u(R) = \cdot \alpha_c^d(R) = \lambda_{\overline{qp}}(\overline{qr}) \cdot \alpha_{c'}^d(R) = \lambda_{\overline{qp}}(\overline{qr}) \cdot (\alpha_{c'}^d)^\sharp(R).$$

Thus

$$(\alpha_c^u)^\sharp(R) = \kappa(R) \cdot (\alpha_{c'}^d)^\sharp(R)$$

for $R = \{p \rightarrow q \rightarrow r \rightarrow \dots\} \in E_c^\sharp \setminus \{E_{c,0}^\sharp \cup N_{c,0}^\sharp\}$.

• For edges $Q_{ia} \in N_{c,0}^\sharp$ of type 2:

We have

$$(\alpha_c^u)^\sharp(Q_{ia}) = \frac{\iota(\alpha(\overline{pp_i}) \wedge \alpha(\overline{pq}_a))}{\langle \xi, \alpha(\overline{pp_i}) \rangle}.$$

On the other hand we have

$$(\alpha_{c'}^d)^\#(Q_{ai}) = \frac{\iota(\alpha(\overline{pq_a}) \wedge \alpha(\overline{pp_i}))}{\langle \xi, \alpha(\overline{pq_a}) \rangle}.$$

Therefore we have

$$\begin{aligned} \frac{\langle \xi, \alpha(\overline{pq_a}) \rangle}{\langle \xi, \alpha(\overline{p_i p}) \rangle} (\alpha_{c'}^d)^\#(Q_{ai}) &= \frac{\langle \xi, \alpha(\overline{pq_a}) \rangle}{\langle \xi, \alpha(\overline{p_i p}) \rangle} \frac{\iota(\alpha(\overline{pq_a}) \wedge \alpha(\overline{pp_i}))}{\langle \xi, \alpha(\overline{pq_a}) \rangle} = \\ &= \frac{\iota(\alpha(\overline{pq_a}) \wedge \alpha(\overline{pp_i}))}{\langle \xi, \alpha(\overline{p_i p}) \rangle} = \frac{\iota(\alpha(\overline{pp_i}) \wedge \alpha(\overline{pq_a}))}{\langle \xi, \alpha(\overline{pp_i}) \rangle} = (\alpha_c^\mu)^\#(Q_{ia}) \end{aligned}$$

(in this penultimate equality we are appealing to the fact that $\alpha(\overline{p_i p}) = -\alpha(\overline{pp_i})$ as in A2 in Definition 1.1.2). Thus we have $(\alpha_c^\mu)^\#(Q_{ia}) = \kappa(Q_{ia}) \cdot (\alpha_{c'}^d)^\#(Q_{ai})$.

• For edges $\overline{Q_{ia}Q_{ib}}$ of type 3:

We have

$$\begin{aligned} (\alpha_c^\mu)^\#(\overline{Q_{ia}Q_{ib}}) &= n^\mu(Q_{ia})\alpha_c^\mu(Q_{ib}) - n^\mu(Q_{ib})\alpha_c^\mu(Q_{ia}) = \\ &= \langle \xi, \alpha(\overline{pq_a}) \rangle \cdot \frac{\iota(\alpha(\overline{pp_i}) \wedge \alpha(\overline{pq_b}))}{\langle \xi, \alpha(\overline{pp_i}) \rangle} - \langle \xi, \alpha(\overline{pq_b}) \rangle \cdot \frac{\iota(\alpha(\overline{pp_i}) \wedge \alpha(\overline{pq_a}))}{\langle \xi, \alpha(\overline{pp_i}) \rangle} = \\ &= \langle \xi, \alpha(\overline{pq_a}) \rangle \alpha(\overline{pq_b}) - \langle \xi, \alpha(\overline{pq_b}) \rangle \alpha(\overline{pq_a}) = \\ &= \iota(\alpha(\overline{pq_a}) \wedge \alpha(\overline{pq_b})) = \langle \xi, \alpha(\overline{pq_a}) \rangle \cdot \alpha_c^d(Q_{ab}) = \langle \xi, \alpha(\overline{pq_a}) \rangle \cdot (\alpha_{c'}^d)^\#(\overline{Q_{ai}Q_{bi}}). \end{aligned}$$

Hence $(\alpha_c^\mu)^\#(\overline{Q_{ia}Q_{ib}}) = \kappa(\overline{Q_{ia}Q_{ib}}) \cdot (\alpha_{c'}^d)^\#(\overline{Q_{ai}Q_{bi}})$.

• For edges $\overline{Q_{ia}Q_{ja}} \in (E_{c,0}^\#)^h$ of type 4:

We have

$$(\alpha_c^\mu)^\#(\overline{Q_{ia}Q_{ja}}) = \alpha_c^\mu(Q_{ij}) = \frac{\iota(\alpha(\overline{pp_i}) \wedge \alpha(\overline{pp_j}))}{\langle \xi, \alpha(\overline{pp_i}) \rangle}.$$

On the other hand we have

$$\begin{aligned} (\alpha_{c'}^d)^\#(\overline{Q_{ai}Q_{aj}}) &= n^d(Q_{ai})\alpha_{c'}^d(Q_{aj}) - n^d(Q_{aj})\alpha_{c'}^d(Q_{ai}) = \\ &= \langle \xi, \alpha(\overline{p_i p}) \rangle \cdot \frac{\iota(\alpha(\overline{pq_a}) \wedge \alpha(\overline{pp_j}))}{\langle \xi, \alpha(\overline{pq_a}) \rangle} - \langle \xi, \alpha(\overline{p_j p}) \rangle \cdot \frac{\iota(\alpha(\overline{pq_a}) \wedge \alpha(\overline{pp_i}))}{\langle \xi, \alpha(\overline{pq_a}) \rangle} = \end{aligned}$$

$$\langle \xi, \alpha(\overline{p_i p}) \rangle \alpha(\overline{p p_j}) - \langle \xi, \alpha(\overline{p_j p}) \rangle \alpha(\overline{p p_i}) = \iota(\alpha(\overline{p p_i}) \wedge \alpha(\overline{p p_j})) = \langle \xi, \alpha(\overline{p p_i}) \rangle (\alpha_c^u)^\#(\overline{Q_{ia} Q_{ja}}).$$

Thus we have $(\alpha_c^u)^\#(\overline{Q_{ia} Q_{ja}}) = \kappa(\overline{Q_{ia} Q_{ja}}) \cdot (\alpha_c^d)^\#(\overline{Q_{ai} Q_{aj}})$.

We leave it as an exercise to verify that $(\lambda_c^u)^\#_\epsilon = \frac{\kappa}{\kappa \circ (\theta_c^u)^\#_\epsilon} \cdot (\lambda_c^d)^\#_\epsilon$ for all $\epsilon \in E_c^\# \equiv E_{c'}^\#$.

Thus we have an equivalence of generalized 1-skeleta

$$(\Gamma_c^\#, (\alpha_c^u)^\#, (\theta_c^u)^\#, (\lambda_c^u)^\#) \equiv (\Gamma_{c'}^\#, (\alpha_{c'}^d)^\#, (\theta_{c'}^d)^\#, (\lambda_{c'}^d)^\#).$$

□

Let $(\Gamma, \alpha, \theta, \lambda) \subset \mathbb{R}^n$ be any d -valent reducible 1-skeleton with connection (not necessarily satisfying condition (ii) of Theorem 2.4.2). For any fixed polarizing vector $\xi \in (\mathbb{R}^d)^*$ and any ξ -compatible Morse function ϕ let c be a ϕ -regular value such that there is a unique vertex $p \in V_\Gamma$ with the property that $\phi(p) < c$. We have the following important observation.

Lemma 2.4.6. *The generalized 1-skeleton $(\Gamma_c, \alpha_c^d, \theta_c^d, \lambda_c^d) \subset \mathbb{R}^{n-1}$ always has a lift.*

Proof. Label the oriented edges at p by $\{\overline{p q_a} \mid 1 \leq a \leq d\} = E_p$. Since p is the only vertex “below” c it follows that Γ_c is a complete graph on $V_c = \{\overline{p q_a}\}$. Let Q_{ab} denote the oriented 2-face containing p spanned by the edges $\overline{p q_a}, \overline{p q_b}$. Then the down-connection gives

$$(\theta_c^d)_{Q_{ab}}(Q_{ac}) = Q_{bc}.$$

Also we compute that

$$(\lambda_c^d)_{Q_{ab}}(Q_{ac}) = 1.$$

See Figure 23 on page 98. Define the constants

$$\{m_{ab} \mid 1 \leq a \neq b \leq d\}$$

by

$$m_{ab} = \frac{\langle \xi, \alpha(\overline{pq_a}) \rangle}{\langle \xi, \alpha(\overline{pq_b}) \rangle}.$$

We have

$$\alpha_c^d(Q_{ab}) = -m_{ba}\alpha_c^d(Q_{ba}) \quad (2.4.14)$$

as the reader can readily verify. We also have

$$\alpha_c^d(Q_{ac}) - \alpha_c^d(Q_{bc}) = m_{cb}\alpha_c^d(Q_{ab}). \quad (2.4.15)$$

Indeed the LHS of (2.4.15) gives

$$\begin{aligned} & \frac{\iota(\alpha_c^d(\overline{pq_a}) \wedge \alpha(\overline{pq_c}))}{\langle \xi, \alpha(\overline{pq_a}) \rangle} - \frac{\iota(\alpha_c^d(\overline{pq_b}) \wedge \alpha(\overline{pq_c}))}{\langle \xi, \alpha(\overline{pq_b}) \rangle} \\ &= \frac{\langle \xi, \alpha(\overline{pq_c}) \rangle}{\langle \xi, \alpha(\overline{pq_b}) \rangle} \alpha(\overline{pq_b}) - \frac{\langle \xi, \alpha(\overline{pq_c}) \rangle}{\langle \xi, \alpha(\overline{pq_a}) \rangle} \alpha(\overline{pq_a}) \\ &= m_{cb} \left(\alpha(\overline{pq_b}) - \frac{\langle \xi, \alpha(\overline{pq_b}) \rangle}{\langle \xi, \alpha(\overline{pq_a}) \rangle} \alpha(\overline{pq_a}) \right) = m_{cb}\alpha_c^d(Q_{ab}). \end{aligned}$$

Fix a vertex $\overline{pq_d} \in V_c$ and define a function

$$(E_c)_{\overline{pq_d}} \xrightarrow{\hat{A}} \mathbb{R}^{d-1} \quad (2.4.16)$$

$$Q_{da} \longrightarrow \vec{e}_a$$

where $\{\vec{e}_a \mid 1 \leq a \leq (d-1)\}$ is the standard basis in \mathbb{R}^{d-1} . Then using the relations (2.4.15)

and (2.4.14) we can extend \hat{A} to a function $A: E_c \rightarrow \mathbb{R}^{d-1}$ by the following prescription:

$$A(Q_{ab}) = \begin{cases} \hat{A}(Q_{db}) & \text{if } a = d \\ -m_{da}\hat{A}(Q_{da}) & \text{if } b = d \\ \hat{A}(Q_{db}) - m_{ba}\hat{A}(Q_{da}) & \text{if } a, b < d \end{cases} \quad (2.4.17)$$

Claim. *The function $A: E_c \rightarrow \mathbb{R}^{d-1}$ is a generalized axial function for the pre 1-skeleton $(\Gamma_c, \theta_c^d, \lambda_c^d)$.*

Clearly A satisfies condition gA1 of Definition 2.2.8. Hence we need only show that

$$A(Q_{ac}) - A(Q_{bc}) \equiv 0 \pmod{A(Q_{ab})}. \quad (2.4.18)$$

There are four cases to consider here.

• $a = d, b, c < d$: (2.4.18) becomes

$$\hat{A}(Q_{dc}) - (\hat{A}(Q_{dc}) - m_{cb}\hat{A}(Q_{db})) = m_{cb}\hat{A}(Q_{db}).$$

• $b = d, a, c < d$: This is the same as the previous case.

• $c = d, a, b < d$: In this case (2.4.18) becomes

$$\begin{aligned} -m_{da}\hat{A}(Q_{da}) + m_{db}\hat{A}(Q_{db}) &= \\ m_{db}(\hat{A}(Q_{db}) - m_{bd}m_{da}\hat{A}(Q_{da})) &= \\ m_{db}(\hat{A}(Q_{db}) - m_{ba}\hat{A}(Q_{da})) &= m_{db}A(Q_{ab}). \end{aligned}$$

• $a, b, c < d$: In this case (2.4.18) becomes

$$\begin{aligned} \hat{A}(Q_{dc}) - m_{ca}\hat{A}(Q_{da}) - (\hat{A}(Q_{dc}) - m_{cb}\hat{A}(Q_{da})) &= \\ m_{cb}(\hat{A}(Q_{db}) - m_{bc}m_{ca}\hat{A}(Q_{da})) &= m_{cb}A(Q_{ab}). \end{aligned}$$

Thus the claim is established.

Note that since α_c^d also satisfies the relations as in (2.4.17) we have $p \circ A = \alpha_c^d$ where $p: \mathbb{R}^{d-1} \rightarrow W_\xi$ is defined on the standard basis by $p(e_a) := \alpha_c^d(Q_{da})$. This shows that $(\Gamma_c, A, \theta_c^d, \lambda_c^d)$ is a lift of the down c -cross-section $(\Gamma_c, \alpha_c^d, \theta_c^d, \lambda_c^d)$. \square

Everything we have done up to this point in this subsection has been aimed toward the following result.

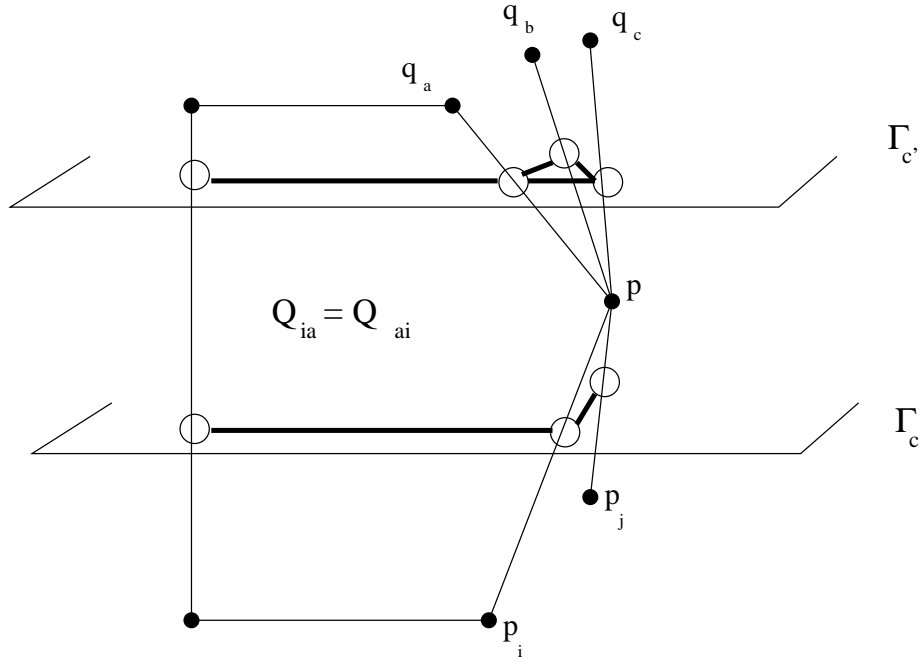

Figure 21. passage over a critical point

Lemma 2.4.7. *Suppose the 1-skeleton $(\Gamma, \alpha, \theta, \lambda) \subset \mathbb{R}^n$ satisfies condition (ii) in Theorem 2.4.2. Then for any ϕ -regular value $c \in \mathbb{R}$, the generalized 1-skeleton*

$$(\Gamma_c, \alpha_c^d, \theta_c^d, \lambda_c^d) \subset W_\xi$$

has a lift.

Proof. Let $c_1 < \dots < c_N$ be ϕ -regular values such that for each $1 \leq i \leq N - 1$ there is a unique vertex $p_i \in V_\Gamma$ such that $c_i < \phi(p_i) < c_{i+1}$ and there are unique vertices p_0 and p_N such that $\phi(p_0) < c_1 < c_N < \phi(p_N)$.

By Lemma 2.4.6 the down cross-section

$$(\Gamma_{c_1}, \alpha_{c_1}^d, \theta_{c_1}^d, \lambda_{c_1}^d)$$

has a lift. By condition (ii) we have

$$(\Gamma_{c_1}, \alpha_{c_1}^\mu, \theta_{c_1}^\mu, \lambda_{c_1}^\mu) \equiv (\Gamma_{c_1}, \alpha_{c_1}^d, \theta_{c_1}^d, \lambda_{c_1}^d).$$

Hence $(\Gamma_{c_1}, \alpha_{c_1}^u, \theta_{c_1}^u, \lambda_{c_1}^u)$ must also have a lift. By Lemma 2.4.4 we conclude that the blow-up generalized 1-skeleton

$$(\Gamma_{c_1}^\#, (\alpha_{c_1}^u)^\#, (\theta_{c_1}^u)^\#, (\lambda_{c_1}^u)^\#)$$

also has a lift. By Lemma 2.4.5 we deduce that

$$(\Gamma_{c_2}^\#, (\alpha_{c_2}^d)^\#, (\theta_{c_2}^d)^\#, (\lambda_{c_2}^d)^\#)$$

also has a lift. By Lemma 2.4.4 again we conclude that

$$(\Gamma_{c_2}, \alpha_{c_2}^d, \theta_{c_2}^d, \lambda_{c_2}^d)$$

also has a lift. We can proceed this way for all i and this completes the proof of Lemma 2.4.7. □

2.4.3 Cutting

We are now more than halfway through the proof of Theorem 2.4.2. In this section we describe another technique introduced by Guillemin and Zara in [14] called *cutting*.

Let $(\Gamma, \alpha, \theta, \lambda)$ be a 1-skeleton that satisfies condition (ii) in Theorem 2.4.2.

Let I be the complete graph on the vertex set labeled $V_I = \{0, 1\}$ (i.e. the single edge graph), let

$$\alpha_I: \begin{cases} \overline{01} \mapsto 1 \\ \overline{10} \mapsto -1 \end{cases}$$

let θ_I be the unique connection on I and let $\lambda_I \equiv 1$. Then $(I, \alpha_I, \theta_I, \lambda_I) \subset \mathbb{R}$ is a 1-valent 1-skeleton in \mathbb{R} .

Let

$$(\hat{\Gamma}, \hat{\alpha}, \hat{\theta}, \hat{\lambda}) \subset \mathbb{R}^n \times \mathbb{R}$$

denote the direct product 1-skeleton with factors $(\Gamma, \alpha, \theta, \lambda) \subset \mathbb{R}^n$ and $(I, \alpha_I, \theta_I, \lambda_I) \subset \mathbb{R}$.

Define the function

$$\eta: \{0, 1\} \rightarrow \text{Hom}_{\mathbb{R}}(\mathbb{R}^n, \mathbb{R}) \cong (\mathbb{R}^n)^*$$

by

$$\eta(t) = \xi$$

for $t = 0, 1$.

This defines a tilt on the direct product 1-skeleton in the sense of Definition 2.3.1 hence we define

$$(\tilde{\Gamma}, \tilde{\alpha}, \tilde{\theta}, \tilde{\lambda}) \subset \mathbb{R}^{n+1}$$

to be the η -tilted product 1-skeleton in the sense of Definition 2.3.2. In other words $\tilde{\alpha} = \hat{\alpha}_\eta$ is the η -tilted axial function on the direct product pre-1-skeleton.

Let $\mathbf{1} \in \mathbb{R}^*$ denote the linear function on \mathbb{R} that maps 1 to 1. Define

$$\hat{\xi} := \frac{1}{2} (\xi, \mathbf{1}) \in (\mathbb{R}^n \times \mathbb{R})^* \cong (\mathbb{R}^n)^* \times \mathbb{R}^*.$$

Observe that we have

$$\langle \hat{\xi}, \hat{\alpha}_\eta(e \times t) \rangle = \langle \xi, \alpha(e) \rangle,$$

hence since ξ is polarizing for $(\Gamma, \alpha, \theta, \lambda) \subset \mathbb{R}^n$ we have that $\hat{\xi}$ is polarizing for $(\hat{\Gamma}, \hat{\alpha}_\eta, \hat{\theta}, \hat{\lambda}) \subset \mathbb{R}^n \times \mathbb{R}$.

Set $\phi_- := \min_{p \in V_\Gamma} (\phi(p))$ and $\phi_+ := \max_{p \in V_\Gamma} (\phi(p))$. Fix $a > \phi_+ - \phi_- > 0$ and define

$$\hat{\phi}: V_{\hat{\Gamma}} \rightarrow \mathbb{R}$$

by

$$v \times t \mapsto \phi(v) + at.$$

Since ϕ is a ξ -compatible Morse function for $(\Gamma, \alpha, \theta, \lambda)$, $\hat{\phi}$ is a $\hat{\xi}$ -compatible Morse function for $(\hat{\Gamma}, \hat{\alpha}_\eta, \hat{\theta}, \hat{\lambda})$. Fix a $\hat{\phi}$ -regular value $c \in \mathbb{R}$ such that

$$\phi_+ < c < \phi_- + a.$$

Lemma 2.4.8. $(\hat{\Gamma}_c, (\hat{\alpha}_\eta)_c^d, \hat{\theta}_c^d, \hat{\lambda}_c^d) \cong (\Gamma, \alpha, \theta, \lambda)$.

Proof. First we observe that the only oriented edges in $\hat{\Gamma}_c := (\hat{V}_c, \hat{E}_c)$ at the c -level are those of the form

$$\overline{(v \times 0)(v \times 1)} \in E_{\hat{\Gamma}}$$

for $v \in V_\Gamma$. Next we note that the oriented 2-faces containing edges of the form

$$\overline{(v \times 0)(v \times 1)}$$

are simply quadrilaterals that are in 1-1 correspondence with the oriented edges $\overline{vw} \in E_\Gamma$; we call $Q_{\overline{vw}}$ the oriented 2-face corresponding to \overline{vw} . Thus we have a natural identification of graphs

$$\begin{aligned} \hat{V}_c \sqcup \hat{E}_c &\xrightarrow{\cong} V_\Gamma \sqcup E_\Gamma & (2.4.19) \\ \overline{(v \times 0)(v \times 1)} &\longrightarrow v \\ Q_{\overline{vw}} &\longrightarrow \overline{vw}. \end{aligned}$$

It is clear that by the definition of the direct product connection $\hat{\theta}$ on $\hat{\Gamma}$ that the identification in (2.4.19) extends to an identification of graph-connection pairs

$$(\Gamma, \theta) \cong (\hat{\Gamma}_c, \hat{\theta}_c).$$

Note that this particular cross-section is actually a 1-skeleton with connection, since all of the 2-faces at the c -level containing a single oriented edge at the c -level in $\hat{\Gamma}$ span distinct 2-planes. Moreover we have

$$\begin{aligned} \hat{\alpha}_c^d(Q_{\overline{vw}}) &:= \hat{\alpha}_\eta(\overline{(v \times 0w \times 0)}) - \frac{\langle \hat{\xi}, \hat{\alpha}_\eta(\overline{(v \times 0w \times 0)}) \rangle}{\langle \hat{\xi}, \hat{\alpha}_\eta(\overline{(v \times 0v \times 1)}) \rangle} \hat{\alpha}_\eta(\overline{(v \times 0v \times 1)}) \\ &= \begin{pmatrix} \alpha(\overline{vw}) \\ \langle \xi, \alpha(\overline{vw}) \rangle \end{pmatrix} - \langle \xi, \alpha(\overline{vw}) \rangle \begin{pmatrix} 0 \\ 1 \end{pmatrix} \end{aligned}$$

$$= \begin{pmatrix} \alpha(\overline{vw}) \\ 0 \end{pmatrix}.$$

Thus the identification in (2.4.19) extends to an identification of 1-skeleta with connections

$$(\hat{\Gamma}_c, (\hat{\alpha}_\eta)_c^d, \hat{\theta}_c^d, \hat{\lambda}_c^d) \equiv (\Gamma, \alpha, \theta, \lambda).$$

Note that since $\alpha = (\hat{\alpha}_\eta)_c^d$ is 2-independent, the compatibility systems λ_c^d and λ are automatically equal (under the identification in (2.4.19)). \square

It is straightforward to see that $(\hat{\Gamma}, \hat{\alpha}_\eta, \hat{\theta}, \hat{\lambda})$ satisfies condition (iii) (hence condition (ii)) in Theorem 2.4.2: Clearly $(\hat{\Gamma}, \hat{\alpha}_\eta, \hat{\theta}, \hat{\lambda})$ is reducible: it has a polarizing covector $\hat{\xi}$ as above and its 2-faces consist of 2-faces of (Γ, α, θ) and quadrilaterals $Q_{\overline{vw}}$ as above. The 2-faces of the form $Q_{\overline{vw}}$ have trivial normal holonomy since $\hat{\Gamma}$ is the direct product 1-skeleton and $\hat{\theta}$ is the direct product connection on $\hat{\Gamma}$. They are also level since the compatibility constants along the edges $\overline{(v \times 0)(v \times 1)}$ are equal to 1. Hence all the 2-faces of $(\hat{\Gamma}, \hat{\alpha}_\eta, \hat{\theta}, \hat{\lambda})$ are level and have trivial normal holonomy since $(\Gamma, \alpha, \theta, \lambda)$ satisfies (iii). This shows that $(\hat{\Gamma}, \hat{\alpha}_\eta, \hat{\theta}, \hat{\lambda})$ satisfies (iii), hence also (ii).

Now we are in a position to complete the proof of Theorem 2.4.2.

Proof of Theorem 2.4.2. We have already shown that (ii) \Leftrightarrow (iii) and (i) \Rightarrow (ii) above. Hence it remains to argue that (ii) \Rightarrow (i). Assume that $(\Gamma, \alpha, \theta, \lambda)$ is a 1-skeleton satisfying condition (ii). Then we have shown that $(\Gamma, \alpha, \theta, \lambda)$ also satisfies (iii). This implies that the η -tilted product $(\hat{\Gamma}, \hat{\alpha}_\eta, \hat{\theta}, \hat{\lambda})$ also satisfies (iii) and hence satisfies (ii) as well. Moreover we know that $(\hat{\Gamma}_c, (\hat{\alpha}_\eta)_c^d, \hat{\theta}_c^d, \hat{\lambda}_c^d)$ has a lift for every $\hat{\phi}$ -regular value c by Lemma 2.4.7. On the other hand we know that $(\hat{\Gamma}_c, (\hat{\alpha}_\eta)_c^d, \hat{\theta}_c^d, \hat{\lambda}_c^d) \equiv (\Gamma, \alpha, \theta, \lambda)$ for some ϕ -regular value c , by Lemma 2.4.8. This shows that $(\Gamma, \alpha, \theta, \lambda) \subset \mathbb{R}^n$ has a lift, $(\Gamma, A, \theta, \lambda) \subset \mathbb{R}^d$ with respect to some projection map $p: \mathbb{R}^d \rightarrow \mathbb{R}^n$. The claim now is that $(\Gamma, A, \theta, \lambda)$ is non-cyclic in

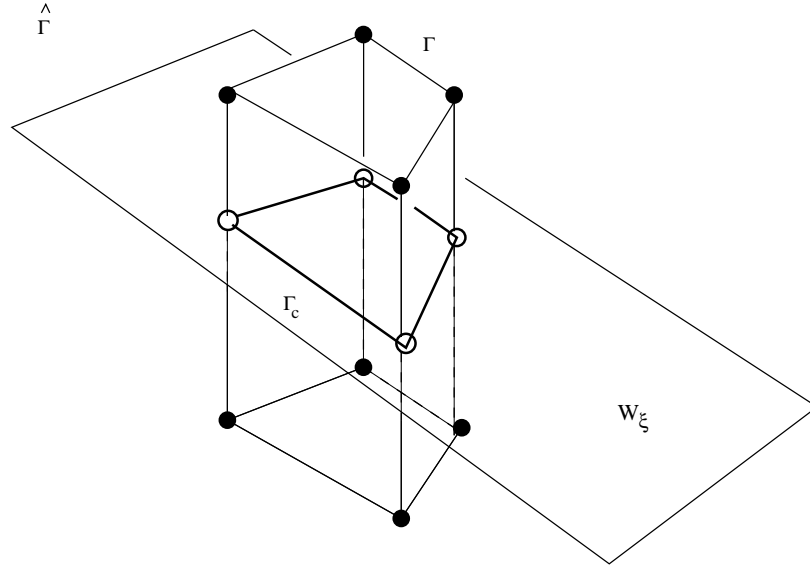

Figure 22. cutting

the sense of Definition 2.2.1. The generalized 1-skeleton $(\Gamma, A, \theta, \lambda)$ clearly has a polarizing covector: given a polarizing covector $\xi \in (\mathbb{R}^n)^*$ for $(\Gamma, \alpha, \theta, \lambda)$, $p^*(\xi) \in (\mathbb{R}^d)^*$ is a polarizing covector for $(\Gamma, A, \theta, \lambda)$. Moreover the 2-slices of $(\Gamma, A, \theta, \lambda)$ are lifts of the 2-faces of $(\Gamma, \alpha, \theta, \lambda)$. The 2-faces $(\Gamma_0, \alpha_0, \theta_0, \lambda_0)$ have $b_0(\Gamma_0, \alpha_0) = 1$, hence the 2-slices $(\Gamma_H^0, \alpha_H^0, \theta_H^0, \lambda_H^0)$ must also have $b_0(\Gamma_H^0, \alpha_H^0) = 1$. Hence $(\Gamma, A, \theta, \lambda)$ is non-cyclic. This shows that (ii) implies (i), and hence completes the proof of Theorem 2.4.2. \square

Remarks. Fix a 1-skeleton with connection $(\Gamma, \alpha, \theta) \subset \mathbb{R}^n$ that is 3-independent and non-cyclic in the sense of Definition 2.2.1.

1. If $(\Gamma, \alpha, \theta) \subset \mathbb{R}^n$ is 4-independent then (Γ, α, θ) automatically satisfies condition (iii) of Theorem 2.4.2. Indeed the non-cyclicity of (Γ, α, θ) implies that the 2-faces are precisely the 2-slices. Furthermore by Corollary 1.3.8 each 2-face is level. If γ is a loop given by any 2-face Q of (Γ, α, θ) and e is any oriented edge normal to Q then $\alpha(K_\gamma(e))$ must lie in the same 3-dimensional subspace spanned by Q and $\alpha(e)$. Thus the 4-independence condition forces $K_\gamma(e) = e$; hence Q must have trivial normal

holonomy. The somewhat surprising conclusion is: Any 4-independent non-cyclic 1-skeleton has a non-cyclic lift.

2. Without 4-independence (but still assuming 3-independence) our result says that if all of the 2-slices of $(\Gamma, \alpha, \theta) \subset \mathbb{R}^n$ have trivial normal holonomy then (Γ, α, θ) satisfies (iii). Thus we have a purely combinatorial criterion for checking if a 3-independent non-cyclic 1-skeleton lifts: A 3-independent non-cyclic 1-skeleton has a non-cyclic lift if and only if all of its 2-slices have trivial normal holonomy.

We have the following corollary of Theorem 2.4.2. For convenience we shall say that a 1-skeleton has the *lifting package* if it satisfies condition (iii) in Theorem 2.4.2.

Corollary 2.4.9. *Suppose the d -valent 1-skeleton $(\Gamma, \alpha, \theta) \subset \mathbb{R}^n$ has*

- i. *the lifting package and*
- ii. *an embedding $f: V_\Gamma \rightarrow \mathbb{R}^n$.*

Then $(\Gamma, \alpha, \theta) \subset \mathbb{R}^n$ is a projected simple polytope.

Proof. Theorem 2.4.2 implies that $(\Gamma, \alpha, \theta, \lambda) \subset \mathbb{R}^n$ has a non-cyclic lift $(\Gamma, A, \theta, \lambda) \subset \mathbb{R}^d$. Thus by Theorem 2.1.5 it suffices to show that $(\Gamma, A, \theta, \lambda)$ admits an embedding $F: V_\Gamma \rightarrow \mathbb{R}^d$. A result of Guillemin and Zara (see chapter 3, Theorem 3.1.14) implies that the map $\pi^*: H(\Gamma, A) \rightarrow H(\Gamma, \alpha)$ induced by the projection morphism $\pi: (\Gamma, \alpha, \theta) \rightarrow (\Gamma, A, \theta)$ is surjective. Hence there is an equivariant class $F \in H^1(\Gamma, A, \theta)$ such that $\pi^*(F) = f$. For every oriented edge $\overline{vw} \in E_\Gamma$ we have

$$F(w) - F(v) = c \cdot A(\overline{vw}),$$

for some $c \in \mathbb{R}$. On the other hand we necessarily have

$$p(F(w)) - p(F(v)) = c \cdot p(A(\overline{vw})) = c \cdot \alpha(\overline{vw}) = f(w) - f(v)$$

hence $c > 0$. This shows that F is an embedding of (Γ, A, θ) . □

We end this chapter with some examples.

In Figure 23 we see a problem after passing over the first critical point. The down cross-section lifts as Lemma 2.4.7 tells us, but the up cross-section has the wrong connection to lift. The problem here is that the (triangular) 2-faces fail to have trivial normal holonomy.

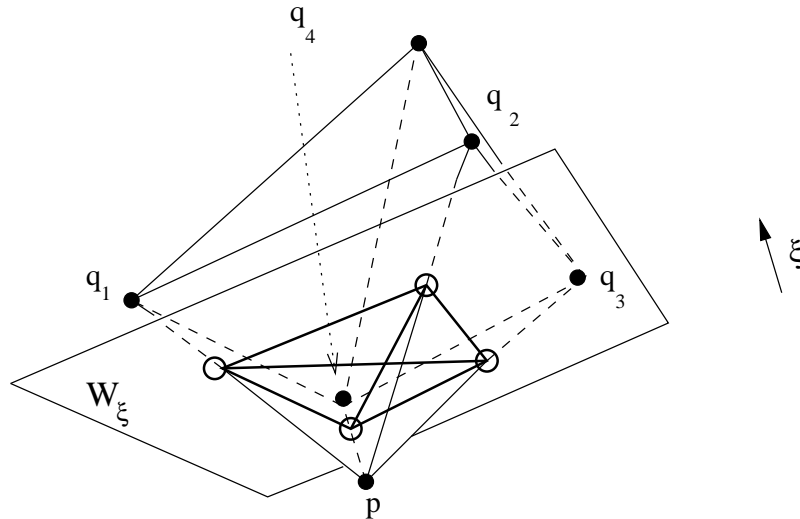

Figure 23. A 3-Independent 1-Skeleton That Does Not Lift.

The 1-skeleton in \mathbb{R}^2 shown in Figure 24 also does not admit a lift (this is easy to see without Theorem 2.4.2: if it did have a lift then it would be the projection of some (simple) 3-polytope which is impossible by Steinitz' theorem (the graph is not 3-connected)). However we see that this 1-skeleton has enough 2-faces (the four outer triangles and the outer and inner hexagons), and these 2-faces all have trivial normal holonomy. The problem in this example is that the triangles fail to be level. One indication of this is that the lines spanned by the directions assigned to the normal edges of a triangle do not meet in a point.

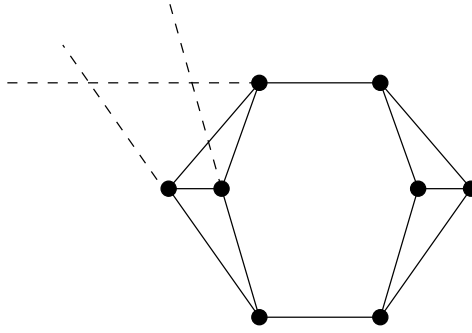

Figure 24. reducible 1-skeleton, 2-faces not straight .

2.5 Concluding Remarks

We have the following problem:

Problem. *When is a given d -valent 1-skeleton with connection $(\Gamma, \alpha, \theta) \subset \mathbb{R}^n$ a projection of a ($-n$ effective) 1-skeleton with connection $(\Gamma, A, \theta) \subset \mathbb{R}^N$ for $n < N \leq d$?*

Theorem 2.4.2 solves this problem for non-cyclic $(\Gamma, A, \theta) \subset \mathbb{R}^d$. Otherwise the problem is wide open.

In lifting problems of the above type, one is reminded of Steinitz' Theorem:

Theorem 2.5.1. *A simple graph G is the graph of a 3-dimensional polytope $P \subset \mathbb{R}^3$ if and only if G is planar and 3-connected.*

In some sense, Theorem 2.5.1 is much stronger than Corollary 2.4.9. Indeed in the statement of Theorem 2.5.1 we are starting with a purely combinatorial object having no geometric structure at all, and producing a convex 3-polytope. Also Theorem 2.5.1 does not require P to be simple; the result holds for *all* 3-dimensional polytopes. On the other hand, while Corollary 2.4.9 holds for any $d \geq 3$, we require our polytopes to be simple and the objects that we start out with already have *some* geometric structure.

However Theorem 2.5.1 can be proved in the same spirit as the proof of Theorem 2.4.2 (and hence also Corollary 2.4.9). Indeed one first introduces basic invertible operations

on planar, 3-connected simple graphs that preserve the lifting property: if the graph lifts before the operation, then it lifts after the operation and vice-versa. In the proof of Theorem 2.4.2 these operations are the blow-up and blow-down. One then shows how to use these operations to transform the given graph into a “simpler” graph. In our case this is the cutting technique. One then shows that this simpler graph has a lift. This is analogous to our Lemma 2.4.6. See [29] chapter 4 for a proof of Theorem 2.5.1 along these lines. Another nice reference for Theorem 2.5.1 (and 3-polytopes in general) is Grünbaum’s book [11].

Crapo and Whiteley give another proof of Theorem 2.5.1 where the graph is given as a bar-joint framework in \mathbb{R}^2 . If a 1-skeleton (Γ, α) admits an embedding $f: V_\Gamma \rightarrow \mathbb{R}^n$, then one gets a bar-joint framework on the graph Γ using f . In [6], Crapo and Whiteley use ideas from rigidity theory to detect which planar bar-joint frameworks arise as projections of 3-polytopes (and more general “polyhedral surfaces”). To my knowledge there is not much known regarding lifting bar-joint frameworks in higher dimensions.

Question. *Does Theorem 2.4.2 have a direct translation in terms of rigidity theory? Does it already have an analogue in rigidity theory?*

Another general question is “Can these techniques be used to obtain results in geometry?”. A couple of problems in this direction are as follows.

Question. *When does the T -action on a GKM T -manifold M , extend to a larger \hat{T} -action?*

If we restrict the T -action of a GKM T -manifold, M , to the action by a sub-torus T_0 such that the restricted action also satisfies GKM 1 and GKM 2 (from Definition 1.7.4), then M becomes a GKM T_0 -manifold. The 1-skeleton for M with its restricted action of T_0 is exactly the projection of the 1-skeleton of M with its larger T -action via the

restriction map $p: \mathfrak{t}^* \rightarrow \mathfrak{t}_0^*$. Requiring T to preserve a (non-degenerate) 2-form on M enforces the restriction $\dim(T) \leq \frac{1}{2} \dim(M) := d$.

If M is a symplectic manifold and the T -action is Hamiltonian, there is a moment map $\mu: M \rightarrow \mathfrak{t}^*$ such that the image of the 0- and 1-dimensional orbits is the 1-skeleton associated to the GKM T -manifold M . In the case where M is a symplectic manifold and the T -action is Hamiltonian with $\dim(T) = d$, M is called a toric manifold.

We can ask the following specialized question:

Question 1. *Given a symplectic manifold (M, ω) of $\dim(M) = 2d$ admitting a Hamiltonian torus action via $T = (S^1)^n$ for $n < d$ under what conditions is M actually a toric manifold such that the T -action on M is actually the restriction of this larger torus action?*

The blow-up, reduction and cutting operations described above all have analogues in symplectic geometry. Therefore one might conjecture that an analogue of Theorem 2.4.2 holds for symplectic, Hamiltonian T -manifolds.

Conjecture 1. *A symplectic manifold (M, ω) of $\dim(M) = 2d$ admitting a Hamiltonian torus action via $T = (S^1)^n$ for $1 < n < d$ is a toric manifold and the T -action the restriction of this larger action if and only if all of the reduced spaces of M are toric manifolds (orbifolds?).*

Another interesting question is

Question 2. *Which 1-skeleta come from GKM T -manifolds?*

In [14], Guillemin and Zara showed that every GKM 1-skeleton satisfying certain integrality conditions comes from a certain non-compact GKM T -manifold.

A *Delzant polytope* in \mathbb{R}^d is a simple d -polytope whose edge directions span generate the lattice $\mathbb{Z}^d \subset \mathbb{R}^d$. Delzant shows in [7] that every Delzant polytope in \mathbb{R}^d is the

moment map image of some $2d$ -dimensional toric manifold (see also [15]). In particular, this implies that 1-skeleta of Delzant polytopes are the 1-skeleta toric manifolds. Then determining which 1-skeleta are projections of 1-skeleta of Delzant polytopes would yield a larger family of 1-skeleta coming from GKM T -manifolds.

Problem 2. *Which 1-skeleta are projections of 1-skeleta of Delzant polytopes?*

Corollary 2.4.9 determines the class of 1-skeleta coming from projections of arbitrary simple polytopes. What additional conditions can we impose to determine projections of the Delzant polytopes?

CHAPTER 3

MORSE PROPERTIES

We now turn our attention to the cohomology rings associated to a 1-skeleton. In this chapter we investigate the S -module structure of the equivariant cohomology ring. In particular we are interested in 1-skeleta whose equivariant cohomology is a free module over the polynomial ring S . In a series of papers [13], [14] and [16] Guillemin and Zara studied 1-skeleta whose equivariant cohomology is free and admits a triangular basis with respect to vertex orderings induced by polarizations. 1-skeleta satisfying such conditions are said to have the *Morse package*. Guillemin and Zara, in [16] were successful in classifying GKM 1-skeleta with the Morse package modulo planar 1-skeleta, using the same reduction and cutting methods as we used in chapter 2. It turns out that their classification result also holds for arbitrary straight 1-skeleta. In this chapter we pick up where they leave off in some sense; we try to shed some light on the class of planar 1-skeleta that have the Morse package. It turns out that in the planar 3-valent case, the Morse package coincides with straightness. Things are more complicated in the higher valency cases. In fact one can construct infinite families of symmetric straight planar 1-skeleta some of which have the Morse package and some of which do not.

This chapter is divided into three sections. In Section 1 we define the Morse package and relate the different notions of straightness (from Definition 1.3.6) to existence of certain equivariant cohomology classes and integrals with a localization formula. At the

end we state the Guillemin-Zara classification result. In Section 2 we focus on planar 1-skeleta. First we classify those 3-valent 1-skeleta which have the Morse package. As an application of this result, we construct an infinite family of 3-valent planar 1-skeleta that have the Morse package. Next we construct an infinite family of higher valency planar 1-skeleta equipped with a dihedral symmetry group. We then show that an infinite subfamily of these has the Morse package. In Section 3 we give a few concluding remarks.

3.1 The Morse Package

In this section we fix a d -valent non-cyclic (in the sense of Definition 2.2.1) 1-skeleton with connection $(\Gamma, \alpha, \theta) \subset \mathbb{R}^n$; when the connection is irrelevant we will omit it and just write (Γ, α) . We also fix a polarizing covector $\xi \in (\mathbb{R}^n)^*$ and a ξ -compatible Morse function $\phi: V_\Gamma \rightarrow \mathbb{R}$.

It will be convenient to think of the acyclic orientation on Γ induced by ξ as giving a partial ordering on the vertex set V_Γ as follows: we say that $v \leq w$ if there is a ξ -oriented path from v to w in Γ . We also have a *total* ordering induced by ϕ : $v \leq w$ if $\phi(v) \leq \phi(w)$. For each vertex $p \in V_\Gamma$ set

$$\mathcal{F}_p := \{q \in V_\Gamma \mid p \leq q\}$$

and

$$F_p := \{q \in V_\Gamma \mid p \leq q\}.$$

For each $p \in V_\Gamma$, set

$$E_p^+ := \{e \in E_p \mid \langle \xi, \alpha(e) \rangle > 0\}$$

the “Up”-oriented edges at p and

$$E_p^- := \{e \in E_p \mid \langle \xi, \alpha(e) \rangle < 0\}$$

the “Down”-oriented edges at p .

Definition 3.1.1. ([14],[16]) A homogeneous equivariant class $\tau_p \in H^*(\Gamma, \alpha)$ is called a generating class for $p \in V_\Gamma$ if it satisfies the following properties:

1. $\tau_p(p) = \prod_{e \in E_p^-} \alpha(e)$ and
2. $\text{supp}(\tau_p) \subset \mathcal{F}_p$.

We say that (Γ, α) admits a generating family if every vertex admits a generating class; i.e. if there is a family of classes

$$\{\tau_p\}_{p \in V_\Gamma} \subset H(\Gamma, \alpha)$$

where τ_p is a generating class for p .

By relaxing the support conditions we obtain a slightly more general family of classes that are sometimes easier to produce.

Definition 3.1.2. A homogeneous equivariant class $\tau_p \in H^*(\Gamma, \alpha)$ is called a pseudo-generating class if it satisfies the following properties:

1. $\tau_p(p) = \prod_{e \in E_p^-} \alpha(e)$ and
2. $\text{supp}(\tau_p) \subset F_p$.

We say that (Γ, α) admits a pseudo-generating family if every vertex admits a pseudo-generating class; i.e. if there is a family of classes

$$\{\tau_p\}_{p \in V_\Gamma} \subset H(\Gamma, \alpha)$$

where τ_p is a pseudo-generating class for p .

Let $V_\Gamma = \{p_1, \dots, p_N\}$ be the vertices labelled according to the total ordering, so that $p_i < p_j$ if $i < j$. Define for $1 \leq i \leq N$ the subspace

$$H_i := \{f \in H(\Gamma, \alpha) \mid \text{supp}(f) \subset F_{p_i}\}.$$

This defines a finite S -module filtration of the equivariant cohomology ring of (Γ, α)

$$0 = H_N \subset H_{N-1} \subset \dots \subset H_2 \subset H_1 = H(\Gamma, \alpha).$$

For each $1 \leq i \leq N$ and each $k \geq 0$ there are exact sequences of \mathbb{R} -vector spaces

$$0 \longrightarrow H_{i+1}^k \xrightarrow{\iota_i} H_i^k \xrightarrow{\epsilon_{p_i}} \prod_{e \in E_{p_i}^-} \alpha(e) \cdot S^{k-\sigma(p_i)} \quad (3.1.1)$$

where ι_i is the natural inclusion and ϵ_{p_i} is evaluation at vertex p_i and $\sigma(p) := \text{ind}_\xi(p)$. Note that any class $\tau \in H^i$ such that $\epsilon_{p_i}(\tau) = \prod_{e \in E_{p_i}^-} \alpha(e) \cdot 1$ is a pseudo-generating class for p_i .

Exactness in (3.1.1) gives the family of inequalities

$$\dim_{\mathbb{R}}(H_i^k) - \dim_{\mathbb{R}}(H_{i+1}^k) \leq \mu_{k-\sigma(p_i)}, \quad (3.1.2)$$

for $k \geq 0$ and for $1 \leq i \leq N$, where

$$\mu_j := \dim_{\mathbb{R}} S^j = \binom{n+j-1}{j}.$$

Summing these inequalities from $i = 1$ to $i = N - 1$ yields the inequality

$$\dim_{\mathbb{R}}(H^k(\Gamma, \alpha)) \leq \sum_{i=1}^d b_i(\Gamma, \alpha) \mu_{k-i} \quad (3.1.3)$$

for all k .

Lemma 3.1.3. ([14]) *The following are equivalent:*

- i. $(\Gamma, \alpha) \subset \mathbb{R}^n$ admits a generating family
- ii. $(\Gamma, \alpha) \subset \mathbb{R}^n$ admits a pseudo-generating family

iii. $\dim_{\mathbb{R}}(H^k(\Gamma, \alpha)) = \sum_{i=1}^d b_i(\Gamma, \alpha) \mu_{k-i}$ for all k .

Proof. In the short exact sequence (3.1.1), the evaluation map ϵ_{p_i} is surjective if and only if there is a pseudo-generating class $\tau_{p_i} \in H_i$ for p_i . In other words (ii) is equivalent to the sequence

$$0 \longrightarrow H_{i+1} \xrightarrow{u_i} H_i \xrightarrow{\epsilon_{p_i}} \prod_{e \in E_p^-} \alpha(e) \cdot S \longrightarrow 0. \quad (3.1.4)$$

being exact. Exactness in (3.1.4) implies that the inequalities in (3.1.2), and thus also in (3.1.3) are all equalities. This shows that (ii) implies (iii). Conversely suppose that (iii) holds. In light of (3.1.3), we see that the only way this could happen is if the inequalities in (3.1.2) are actually equalities. But this implies together with the exactness of (3.1.1) that (3.1.4) is exact on the right, hence (ii) holds.

Now we will show the equivalence of (i) and (ii). One direction is obvious: since $\mathcal{F}_p \subset F_p$ for every vertex $p \in V_\Gamma$, a generating class is a pseudo-generating class, hence (i) implies (ii). Conversely assume that there is a pseudo-generating class for every vertex of Γ . We will show that there is a generating class for every vertex of Γ . Fix $p \in V_\Gamma$ and let $\tau_p \in H^*(\Gamma, \alpha)$ be a pseudo-generating class for p . Let $q \in (F_p \setminus \mathcal{F}_p) \cap \text{supp}(\tau_p)$ be the smallest vertex. Then we must have that

$$\tau_p(q) = K \cdot \prod_{e \in E_q^-} \alpha(e)$$

for some non-zero $K \in S$. Let $\tau_q \in H(\Gamma, \alpha)$ be a pseudo-generating class for q . Define

$$\tilde{\tau}_p := \tau_p - K\tau_q.$$

Then $\tilde{\tau}_p \in H(\Gamma, \alpha)$ has

$$\tilde{\tau}_p(p) = \prod_{e \in E_p^-} \alpha(e)$$

and

$$\text{supp}(\tilde{\tau}_p) \subset F_p$$

and the smallest vertex in the set

$$(F_p \setminus \mathcal{F}_p) \cap \text{supp}(\tilde{\tau}_p)$$

is larger than the smallest vertex in

$$(F_p \setminus \mathcal{F}_p) \cap \text{supp}(\tau_p).$$

This procedure will clearly terminate since there are only finitely many vertices, and when it does we will be left with a class $\tau_p \in H^*(\Gamma, \alpha)$ such that

$$\tau_p(p) = \prod_{e \in E_p^-} \alpha(e)$$

and

$$(F_p \setminus \mathcal{F}_p) \cap \text{supp}(\tau_p) = \emptyset :$$

since $\text{supp}(\tau_p) \subset F_p$, the class τ_p must be a generating class for p . This shows that (ii) is equivalent to (i), and hence completes the proof of Lemma 3.1.3. \square

Definition 3.1.4. $(\Gamma, \alpha) \subset \mathbb{R}^n$ has the Morse package if it satisfies any of the conditions in Lemma 3.1.3.

Proposition 3.1.5. If $(\Gamma, \alpha) \subset \mathbb{R}^n$ has the Morse package, then $H(\Gamma, \alpha)$ is a free S -module.

Proof. Let $\{\tau_p\}_{p \in V_\Gamma}$ be a generating family for (Γ, α) . We will show that these classes are an S -basis for $H(\Gamma, \alpha)$.

First let us show that they generate $H(\Gamma, \alpha)$: For any homogeneous class $f \in H(\Gamma, \alpha)$ define the *height* of f to be the smallest vertex $h(f)$ (with respect to “ \leq ”) in $\text{supp}(f)$. We prove that every homogeneous class $f \in H(\Gamma, \alpha)$ is in the S -span of $\{\tau_p\}_{p \in V_\Gamma}$ by downward induction on the $h(f)$.

If $h(f)$ is the maximum, then f evaluate to zero on all the neighbors of $h(f)$, hence $f(h(f))$ must be divisible by $\prod_{i(e)=h(f)} \alpha(e)$. This implies that the class f is an S -multiple of the class $\tau_{h(f)}$. This is the base case.

Now assuming the assertion holds for classes f' with $h(f') > q \in V_\Gamma$, let f be a homogeneous class with $h(f) = q$. For each vertex $x \in V_\Gamma$ such that $\overline{qx} \in E_q^-$ we necessarily have $f(x) = 0$ since $x < q$. Therefore there is an element $c_q \in S$ such that $f(q) = c_q \cdot \tau_q(q)$. Thus $\tilde{f} = f - c_q \tau_q$ is a homogeneous class with $h(\tilde{f}) < h(f)$. Therefore by induction, \tilde{f} and therefore f lie in the S -span of $\{\tau_p\}_{p \in V_\Gamma}$.

Now we will show that the generating classes are S -linearly independent. Suppose there is a non-trivial dependence relation

$$\sum_{p \in V_\Gamma} c_p \tau_p, \quad c_p \in S \tag{3.1.5}$$

Let $q \in V_\Gamma$ be the smallest vertex such that $c_q \neq 0$. Note that for $p > q$, $\tau_p(q) = 0$. Hence evaluating (3.1.5) at q yields $c_q \tau_q(q) = 0$ which implies that $c_q = 0$, a contradiction. Therefore there is no non-trivial dependence relation among the $\{\tau_p\}_{p \in V_\Gamma}$, hence they are S linearly independent. This completes the proof of Proposition 3.1.5. \square

Remark. *This notion of the “Morse package of a 1-skeleton” was invented by Guillemin and Zara and seems to have evolved out of the series of papers [13],[14] and [16] although the term itself only appears in [16]. The argument in the proof of Lemma 3.1.3 is essentially the one given by Guillemin and Zara in [14]. Definition 3.1.4 appears in [16], although in that paper they make the blanket assumption that all 1-skeleta are GKM.*

3.1.1 Holonomy, Normal Straight-ness, and Equivariant Thom Classes

Let $\gamma: p_0 \rightarrow p_1 \rightarrow \dots \rightarrow p_{r-1} \rightarrow p_r$ be a path in Γ starting at p_0 and ending at p_r .

Recall that the path connection for γ is

$$K_\gamma = \theta_{\overline{p_{r-1}p_r}} \circ \dots \circ \theta_{\overline{p_0p_1}}: E_{p_0} \rightarrow E_{p_r}$$

and the path connection number for γ is

$$|K_\gamma| := \left(\prod_{i(e)=p_0} \lambda_{\overline{p_0p_1}}(e) \right) \cdots \left(\prod_{i(e)=p_{r-1}} \lambda_{\overline{p_{r-1}p_r}}(e) \right).$$

Suppose that $\gamma': p_r \rightarrow \dots \rightarrow p_s$ is another path in Γ starting at p_r and ending at p_s .

Then we get a new path by concatenation

$$\gamma'' := \gamma \cdot \gamma': p_0 \rightarrow \dots \rightarrow p_r \rightarrow \dots \rightarrow p_s.$$

In this case we have

$$|K_{\gamma''}| = |K_{\gamma \cdot \gamma'}| = |K_\gamma| \cdot |K_{\gamma'}|.$$

If $p_s = p_0$ then γ'' is a loop in Γ and in this case we call $K_{\gamma''}$ the *holonomy map* for the loop and $|K_\gamma|$ the *holonomy number* for the loop. In particular we can traverse the path γ in the opposite direction to get the *opposite path*

$$\bar{\gamma}: p_r \rightarrow \dots \rightarrow p_0$$

and we get the loop

$$\gamma \cdot \bar{\gamma}.$$

Note the compatibility constants satisfy the identity

$$\lambda_{\bar{e}}(e') = \frac{1}{\lambda_e(\theta_{\bar{e}}(e'))}$$

for all $e \in E_\Gamma$ and all $e' \in E_{t(e)}$. Hence we have that

$$|K_{\bar{\gamma}}| = \frac{1}{|K_\gamma|}.$$

Thus the holonomy number for loops of the form $\gamma \cdot \bar{\gamma}$ is always equal to 1.

Given a sub-skeleton $(\Gamma_0, \alpha_0, \theta_0)$, define the normal connection maps by

$$(\theta_0^\perp)_e := \theta_e|_{N_{i(e)}^0}$$

for $e \in E_0$.

Recall (see Definition 1.3.6) that (Γ, α, θ) is *straight* if $|K_\gamma| = 1$ for all loops γ in Γ . The sub-skeleton $(\Gamma_0, \alpha_0, \theta_0)$ is *normally straight* if $|K_\gamma^\perp| = 1$ for all loops γ in Γ_0 . Also the sub-skeleton $(\Gamma_0, \alpha_0, \theta_0)$ is *level* if for any loop $\gamma: p_0 \rightarrow \cdots \rightarrow p_{s-1} \rightarrow p_0$ where $K_\gamma(e) = e$ for some $e \in N_{p_0}^0$ we have

$$|K_\gamma(e)| := \prod_{i=0}^{s-1} \lambda_{p_i p_{i+1}}(\theta_{p_{i-1} p_i} \circ \theta_{p_0 p_1}(e)) = 1.$$

Lemma 3.1.6. *If $(\Gamma_0, \alpha_0, \theta_0)$ is level, then $(\Gamma_0, \alpha_0, \theta_0)$ is normally straight.*

Proof. Let $\gamma: p_0 \rightarrow p_1 \rightarrow \cdots \rightarrow p_{r-1} \rightarrow p_0$ be any loop in Γ_0 . The map

$$K_\gamma^\perp: N_{p_0}^0 \rightarrow N_{p_0}^0$$

is a permutation of a finite set. Hence there is a positive integer M such that

$$K_\gamma^\perp \circ \cdots \circ K_\gamma^\perp := (K_\gamma^\perp)^M = I.$$

We have

$$(K_\gamma^\perp)^M = K_{\gamma^M}^\perp$$

where $\gamma^M = \gamma \cdots \gamma$ (M -times). Therefore since $(\Gamma_0, \alpha_0, \theta_0)$ is level we have $|(K_\gamma^\perp)^M(e)| = 1$ for every $e \in N_{p_0}^0$. Hence

$$\prod_{e \in N_{p_0}^0} |(K_\gamma^\perp)^M(e)| = |K_{\gamma^M}^\perp| = |K_\gamma^\perp|^M = 1.$$

Since $|K_\gamma^\perp| > 0$ we must have that $|K_\gamma^\perp| = 1$, hence $(\Gamma_0, \alpha_0, \theta_0)$ is normally straight. \square

Proposition 3.1.7. *Let $(\Gamma_0, \alpha_0, \theta_0) \subset (\Gamma, \alpha, \theta)$ be a totally geodesic sub-skeleton. Then $(\Gamma_0, \alpha_0, \theta_0)$ has a Thom class if and only if $(\Gamma_0, \alpha_0, \theta_0)$ is normally straight.*

Proof. Assume that $(\Gamma_0, \alpha_0, \theta_0)$ is normally straight. Fix a vertex $p_0 \in V_0$. We will define a function $\tau_0: V_\Gamma \rightarrow S$ as follows.

To define τ_0 on $\{p_0\} \sqcup (V_\Gamma \setminus V_0)$ set

$$\tau_0(q) = \begin{cases} \prod_{e \in N_{p_0}^0} \alpha(e) & \text{if } q = p_0 \\ 0 & \text{if } q \notin V_0 \end{cases}$$

For $p_r \in V_0$ let $\gamma_r: p_0 \rightarrow \cdots \rightarrow p_r$ be any path in Γ_0 and define

$$\tau(p_r) := |K_{\gamma_r}^\perp| \prod_{e \in N_{p_r}^0} \alpha(e).$$

Since $(\Gamma_0, \alpha_0, \theta_0)$ is normally straight, this value is independent of the path γ_r : if $\gamma'_r: p_0 \rightarrow \cdots \rightarrow p_r$ is another path in Γ_0 , then $\gamma_r \cdot \overline{\gamma'_r}: p_0 \rightarrow \cdots \rightarrow p_0$ is a loop, hence

$$|K_{\gamma_r}^\perp| \cdot |K_{\gamma'_r}^\perp| = \frac{|K_{\gamma_r}^\perp|}{|K_{\gamma'_r}^\perp|} = 1.$$

Consequently, the function thus defined is an equivariant class on (Γ, α, θ) . Indeed suppose that $\overline{p_r p_s} \in E_0$ is an edge. We have

$$\tau_0(p_r) = |K_{\gamma_r}^\perp| \prod_{e \in N_{p_r}^0} \alpha(e)$$

and

$$\tau_0(p_s) = |K_{\gamma_s}^\perp| \prod_{e \in N_{p_s}^0} \alpha(e).$$

But we can take path γ_s to be the path

$$\gamma_s = \gamma \cdot \{p_r \rightarrow p_s\}: p_0 \rightarrow \cdots \rightarrow p_r \rightarrow p_s,$$

hence we see that

$$|K_{\gamma_s}^\perp| = |K_{\gamma_r}^\perp| \cdot \left(\prod_{e \in N_{p_r}^0} \lambda_{\overline{p_r p_s}}(e) \right),$$

thus $\tau_0(p_r) - \tau_0(p_s) \equiv 0 \pmod{\alpha(\overline{p_r p_s})}$.

Conversely, assume that $(\Gamma_0, \alpha_0, \theta_0)$ supports a Thom class, $\tau_0: V_\Gamma \rightarrow S$. For each $p \in V_0$ there is a positive constant $c_p \in \mathbb{R}_+$ such that

$$\tau_0(p) = c_p \prod_{e \in N_p^0} \alpha(e).$$

Since τ_0 is an equivariant class, these constants must satisfy the following condition: For each $\overline{pq} \in E_0$,

$$\frac{c_q}{c_p} = \prod_{e \in N_p^0} \lambda_{\overline{pq}}(e).$$

Now let $\gamma: p_0 \rightarrow p_1 \rightarrow \cdots \rightarrow p_{r-1} \rightarrow p_0$ be any loop in Γ_0 . Then we must have

$$|K_\gamma^\perp| = \frac{c_{p_1}}{c_{p_0}} \cdots \frac{c_{p_0}}{c_{p_{r-1}}} = 1$$

hence $(\Gamma_0, \alpha_0, \theta_0)$ is normally straight. This completes the proof of Proposition 3.1.7. \square

Recall that given a k -dimensional sub-space $H \subset \mathbb{R}^n$, and a vertex $p \in V_\Gamma$, there is a unique maximal totally geodesic sub-skeleton $(\Gamma_H^0, \alpha_H^0, \theta_H^0)$ containing p such that $\alpha_H^0(E_H^0) \subset H$, called the k -slice corresponding to H at p of (Γ, α, θ) . We have the following corollary of Proposition 3.1.7.

Corollary 3.1.8. *Every k -slice has a Thom class.*

Proof. By Theorem 1.3.8 in chapter 1 every k -slice is level. By Lemma 3.1.3 every k -slice is also normally straight. Thus by Proposition 3.1.7, every k -slice has a Thom class. \square

Other sub-skeleta that always admit Thom classes are the 0- and 1-valent sub-skeleta; that is the vertices and edges of Γ , respectively. Given $p \in V_\Gamma$, and any non-zero constant $C \in \mathbb{R}$ define the function

$$\tau_p: V_\Gamma \rightarrow S^d$$

by

$$\tau_p(q) = \begin{cases} C \prod_{e \in E_p} \alpha(e) & \text{if } q = p \\ 0 & \text{if } q \neq p. \end{cases}$$

We call τ_p a *top-class at p* . We say that τ_p is a *non-vanishing top-class* if $\overline{\tau_p} \neq 0$ in $\overline{H(\Gamma, \alpha)}$. The non-vanishing top classes will play an important role in the sequel, when we discuss integrals with localization formulae.

For $e = \overline{pq} \in E_\Gamma$ define the function

$$\sigma_e: V_\Gamma \rightarrow S^{d-1}$$

$$\sigma_e(x) = \begin{cases} \prod_{e \in E_p \setminus \overline{pq}} \alpha(e) & \text{if } x = p \\ \prod_{e \in E_p} \lambda_{\overline{pq}}(e) \prod_{e \in E_p \setminus \overline{pq}} \alpha(\theta_{\overline{pq}}(e)) & \text{if } x = q \\ 0 & \text{if } x \neq p, q \end{cases}$$

Then σ_e is a homogeneous class of degree $(d - 1)$ with $\text{supp}(\sigma_e) = \{p, q\}$, hence it is a Thom class for e . We will refer to σ_e as the *edge-class of e* .

3.1.2 Straight-ness, Top Classes, and Localization

Definition 3.1.9. An integral on (Γ, α, θ) is any non-zero graded S -module homomorphism

$$\int_\Gamma: H(\Gamma, \alpha) \rightarrow S[d].$$

We say the integral has a localization formula if there exist constants $\{c_p\}_{p \in V_\Gamma} \subset \mathbb{R}_+$ such that

$$\int_\Gamma f = \sum_{p \in V_\Gamma} \frac{f(p)}{c_p \prod_{i(e)=p} \alpha(e)}.$$

The important point here is that the sum

$$\sum_{p \in V_\Gamma} \frac{f(p)}{c_p \prod_{i(e)=p} \alpha(e)}$$

lies in S and not just in the field of fractions $Q(S)$.

Proposition 3.1.10. *The following are equivalent:*

A. (Γ, α, θ) has an integral with a localization formula

B. (Γ, α, θ) has a non-vanishing top-class

C. (Γ, α, θ) is straight.

Proof. (A \Rightarrow B):

Assume that (Γ, α) has an integral with localization formula. Let $\tau_p \in H^d(\Gamma, \alpha)$ be the class defined by

$$\tau_p(q) = \begin{cases} \prod_{i(e)=p} \alpha(e) & \text{if } q = p \\ 0 & \text{if } q \neq p. \end{cases} \quad (3.1.6)$$

Then

$$\int_{\Gamma} \tau_p = \sum_{q \in V_{\Gamma}} \frac{\tau_p(q)}{c_q \prod_{i(e)=q} \alpha(e)} = \frac{1}{c_p} \neq 0.$$

Since \int_{Γ} is an S -module homomorphism, the class in ordinary cohomology $\overline{\tau_p} \in \overline{H(\Gamma, \alpha)}$ must be non-zero.

(B \Rightarrow C):

Assume that (Γ, α) has a non-vanishing top-class $\tau \in H^d(\Gamma, \alpha)$. Suppose that $\text{supp}(\tau) = \{p\}$. We may assume after possibly re-scaling that $\tau: V_{\Gamma} \rightarrow S^d$ is defined by (3.1.6).

Let

$$\gamma: p_0 \rightarrow p_1 \rightarrow \cdots \rightarrow p_r \rightarrow p_0$$

be any loop. We would like to show that $|K_{\gamma}| = 1$. Let γ_i be the path along γ from p to p_i :

$$\gamma_i: p_0 \rightarrow p_1 \rightarrow \cdots \rightarrow p_i.$$

Thus $\gamma_{r+1} = \gamma$ is the whole loop. For each $1 \leq i \leq r + 1$, denote by σ_i the edge-class $\overline{\sigma_{p_{i-1}p_i}} \in H^{d-1}(\Gamma, \alpha)$. Define

$$\tau_1 := \alpha(\overline{p_1 p_0}) \cdot \sigma_1 + \tau$$

and inductively define

$$\tau_i := |K_{\gamma_{i-1}}| \alpha(\overline{p_i p_{i-1}}) \cdot \sigma_i + \tau_{i-1}. \quad (3.1.7)$$

Since

$$|K_{\gamma_i}| = \prod_{e \in E_{p_{i-1}}} \lambda_{\overline{p_{i-1} p_i}}(e) |K_{\gamma_{i-1}}|, \quad (3.1.8)$$

we can explicitly compute τ_i :

$$\tau_i(q) = \begin{cases} |K_{\gamma_i}| \prod_{i(e)=p_i} \alpha(e) & \text{if } q = p_i \\ 0 & \text{if } q \neq p_i. \end{cases}$$

Note that $\text{supp}(\tau_i) = \{p_i\}$ and that $\overline{\tau_i} = \overline{\tau}$ for all $1 \leq i \leq r+1$, by (3.1.7). On the other hand we have

$$\tau_{r+1}(q) = \begin{cases} |K_{\gamma}| \prod_{i(e)=p} \alpha(e) & \text{if } q = p \\ 0 & \text{if } q \neq p \end{cases}$$

hence $\tau_{r+1} = |K_{\gamma}| \tau$. But $\overline{\tau_{r+1}} = \overline{\tau}$, hence $|K_{\gamma}| = 1$, and this proves that (Γ, α, θ) is straight.

(C \Rightarrow A):

Assume that (Γ, α) is straight. Fix a basepoint $p \in V_{\Gamma}$. Set $c_p = 1$. For a different vertex q , let $\gamma_q: p \rightarrow p_1 \rightarrow \cdots \rightarrow p_k \rightarrow q$ be any path from p to q and define $c_q = |K_{\gamma_q}|$. Note that if

$$\gamma'_q: p \rightarrow p'_1 \rightarrow \cdots \rightarrow p'_m \rightarrow q$$

is another path from p to q , then

$$\gamma := \gamma_q \cdot \overline{\gamma'_q}: p \rightarrow \cdots \rightarrow p_k \rightarrow q \rightarrow p'_m \rightarrow \cdots \rightarrow p$$

is a loop based at p and

$$|K_{\gamma}| = |K_{\gamma_q}| \cdot |K_{\overline{\gamma'_q}}| = |K_{\gamma_q}| \cdot \frac{1}{|K_{\gamma'_q}|}.$$

Since (Γ, α, θ) is straight $|K_\gamma| = 1$, so we have $|K_{\gamma_q}| = |K_{\gamma'_q}|$. Hence c_q is independent of the path γ_q chosen. Consequently, for any edge $\overline{pq} \in E_p$ we have that

$$\frac{c_q}{c_p} = \prod_{e \in E_p} \lambda_{\overline{pq}}(e),$$

by (3.1.8).

Now we want to show that for this choice of constants $\{c_p\}_{p \in V_\Gamma}$, the sum

$$\sum_{p \in V_\Gamma} \frac{f(p)}{c_p \prod_{i(e)=p} \alpha(e)} \quad (3.1.9)$$

is in S for every homogeneous equivariant class $f \in H^k(\Gamma, \alpha)$. The following argument is due to Guillemin and Zara ([13]).

By finding the least common denominator we can write the sum in (3.1.9) as

$$\frac{g}{\prod_{i=1}^N \alpha_i}$$

where $\{\alpha_i\}_{i=1}^N$ is a complete list of all of the directions that occur in the denominators in (3.1.9) and $\{\alpha_i\}_{i=1}^N$ is pairwise linearly independent and $g \in S$. We will show that for any i , α_i divides g .

We can partition V_Γ into two disjoint subsets:

$$V_\Gamma^1 = \{q \in V_\Gamma \mid \text{there is } e \in E_q \text{ with } \alpha(e) = K\alpha_i\}$$

and

$$V_\Gamma^2 = V_\Gamma \setminus V_\Gamma^1.$$

We write the sum in (3.1.9) as

$$\sum_{p \in V_\Gamma} \frac{f(p)}{c_p \prod_{i(e)=p} \alpha(e)} = \sum_{p \in V_\Gamma^1} \frac{f(p)}{c_p \prod_{i(e)=p} \alpha(e)} + \sum_{p \in V_\Gamma^2} \frac{f(p)}{c_p \prod_{i(e)=p} \alpha(e)}. \quad (3.1.10)$$

Since α_i is coprime with $\alpha(e)$ for each $p \in V_\Gamma^2$ and every $e \in E_p$, we can write the second summand on the RHS of (3.1.10) as

$$\sum_{p \in V_\Gamma^2} \frac{f(p)}{c_p \prod_{i(e)=p} \alpha(e)} = \frac{g_2}{\prod_{j \neq i} \alpha_j}. \quad (3.1.11)$$

For each $p \in V_\Gamma^1$ note that there is a unique vertex $q \in V_\Gamma^1$ such that $\overline{pq} \in E_\Gamma$ and $\alpha(\overline{pq}) = K\alpha_i$ for some $K \in \mathbb{R}$. Write the set of such oriented edges as E_Γ^i . Then by pairing terms we can write the first summand in (3.1.10) as

$$\sum_{p \in V_\Gamma^1} \frac{f(p)}{c_p \prod_{i(e)=p} \alpha(e)} = \frac{1}{2} \sum_{\overline{pq} \in E_\Gamma^i} \left(\frac{f(p)}{c_p \prod_{i(e)=p} \alpha(e)} + \frac{f(q)}{c_q \prod_{i(e')=q} \alpha(e')} \right). \quad (3.1.12)$$

Consider a term in the sum on the RHS of (3.1.12). Finding a common denominator we can write the “ \overline{pq} ” term as

$$\frac{f(p)c_q \prod_{e' \neq \overline{qp}} \alpha(e') - f(q)c_p \prod_{e \neq \overline{pq}} \alpha(e)}{c_p c_q \prod_{e \neq \overline{pq}} \alpha(e) \prod_{e' \neq \overline{qp}} \alpha(e') \alpha(\overline{pq})}. \quad (3.1.13)$$

We can rewrite the numerator in (3.1.13) as

$$f(p)c_q \prod_{e \neq \overline{pq}} \alpha(\theta_{\overline{pq}}(e)) - f(q)c_p \prod_{e \neq \overline{pq}} \alpha(e). \quad (3.1.14)$$

Recall that $c_q = \prod_{e \in E_p} \lambda_{\overline{pq}}(e) c_p$ and that

$$\alpha(e) - \lambda_{\overline{pq}}(e) \alpha(\theta_{\overline{pq}}(e)) \equiv 0 \pmod{\alpha(\overline{pq})}.$$

Hence from (3.1.14) we get the equivalence

$$f(p)c_q \prod_{e \neq \overline{pq}} \alpha(\theta_{\overline{pq}}(e)) - f(q)c_p \prod_{e \neq \overline{pq}} \alpha(e) \equiv f(p)c_p \prod_{e \neq \overline{pq}} \alpha(e) - f(q)c_p \prod_{e \neq \overline{pq}} \alpha(e), \quad (3.1.15)$$

and the RHS of (3.1.15) is divisible by $\alpha(\overline{pq})$ since f is an equivariant class. Hence the sum on the RHS of (3.1.12) can be written

$$\frac{1}{2} \sum_{\overline{pq} \in E_\Gamma^i} \left(\frac{f(p)}{c_p \prod_{i(e)=p} \alpha(e)} + \frac{f(q)}{c_q \prod_{i(e')=q} \alpha(e')} \right) = \frac{1}{2} \sum_{\overline{pq} \in E_\Gamma^i} \frac{G_{p,q}}{c_p c_q \prod_{e \neq \overline{pq}} \alpha(e) \prod_{e' \neq \overline{qp}} \alpha(e')} \quad (3.1.16)$$

for some $G_{p,q} \in S$. Now the main point is that the denominators of the summands on the RHS are all co-prime to α_i (since the sets $\alpha(E_p)$ and $\alpha(E_q)$ are each 2-independent).

Thus we can write (3.1.16) as

$$\frac{1}{2} \sum_{\overline{pq} \in E_\Gamma^i} \frac{G_{p,q}}{c_p c_q \prod_{e \neq \overline{pq}} \alpha(e) \prod_{e' \neq \overline{qp}} \alpha(e')} = \frac{g_1}{\prod_{j \neq i} \alpha_j}. \quad (3.1.17)$$

Hence combining (3.1.11) with (3.1.17) we can write

$$\frac{g}{\prod_{j=1}^N \alpha_j} = \frac{g_1}{\prod_{j \neq i} \alpha_j} + \frac{g_2}{\prod_{j \neq i} \alpha_j},$$

hence α_i divides g for any i and hence

$$\sum_{p \in V_\Gamma} \frac{f(p)}{c_p \prod_{e \in E_p} \alpha(e)}$$

is in S . This completes the proof of Proposition 3.1.10. \square

An important corollary of the proof of Proposition 3.1.10 is the following.

Corollary 3.1.11. *(Γ, α, θ) is straight if and only if there exist positive constants, unique up to scaling, $\{c_p\}_{p \in V_\Gamma} \subset \mathbb{R}_+$ such that whenever $\overline{pq} \in E_\Gamma$,*

$$\frac{c_q}{c_p} = \prod_{e \in E_p} \lambda_{\overline{pq}}(e).$$

Remark. *If (Γ, α) has the Morse package then it has a non-vanishing top-class; one such class will be the generating class for the maximal vertex of V_Γ (with respect to \leq). Hence by Proposition 3.1.10, (Γ, α) will also have an integral with a localization formula.*

We have already alluded to the fact that 1-skeleta of simple d -polytopes have the Morse package. This fact is almost trivial for the $d = 2$ case; we state it as a lemma here as we will refer to it later.

Lemma 3.1.12. *Suppose that $(\Gamma, \alpha) \subset \mathbb{R}^2$ is 2-valent. Then (Γ, α) has the Morse package.*

Proof. Fix a polarizing covector ξ . Note that

$$b_i(\Gamma, \alpha) = \begin{cases} 1 & \text{if } i = 0, 2 \\ |V_P| - 2 & \text{if } i = 1. \end{cases}$$

A generating class for the unique minimum of (Γ, α) (with respect to ξ) is given by the constant function $\mathbf{1} \in H^0(\Gamma, \alpha)$ that assigns 1 to every vertex. A generating class for

the unique maximum is just a top-class supported at that vertex. Generating classes for vertices v of index 1 is just given by the edge class of the unique edge directed upwards at v . Hence (Γ, α) admits a generating family. \square

The following proposition gives a useful criterion for checking the straightness of a (non-cyclic) 1-skeleton.

Proposition 3.1.13. $(\Gamma, \alpha, \theta) \subset \mathbb{R}^n$ is straight if and only if every 2-slice $(\Gamma_H^0, \alpha_H^0, \theta_H^0)$ is straight.

Proof. First we check the easy direction: assume that (Γ, α, θ) is straight. Fix a 2-slice $(\Gamma_H^0, \alpha_H^0, \theta_H^0)$ and fix a loop γ in Γ_H^0 . Note that $(\Gamma_H^0, \alpha_H^0, \theta_H^0)$ is normally straight by Lemma 3.1.6. Therefore the holonomy number for γ in Γ factors

$$|K_\gamma| = |K_\gamma^\perp| \cdot |(K_H^0)_\gamma| = 1.$$

Since $|K_\gamma| = 1$ and $|K_\gamma^\perp| = 1$ we must also have the $|(K_H^0)_\gamma| = 1$, hence $(\Gamma_H^0, \alpha_H^0, \theta_H^0)$ is straight.

The other direction is a little more work. Assume that all the 2-slices are straight. Let p be the unique minimum of Γ with respect to the partial order induced by our fixed polarizing covector ξ , and let $\gamma: p \rightarrow \cdots \rightarrow p$ be any loop in Γ based at $p \in V_\Gamma$. We want to show that $|K_\gamma| = 1$. Define the *m-height* of γ , to be the pair consisting of the vertex $h(\gamma) \in V_\gamma$ which is the largest vertex of γ (with respect to “ \leq ”) and the number $\mu(\gamma) \in \mathbb{Z}_{\geq 0}$ which is the number of times the path γ passes through the vertex $h(\gamma)$ (the “multiplicity of $h(\gamma)$ in γ ”). We endow the set $V_\Gamma \times \mathbb{Z}_{\geq 0}$ with the lexicographic ordering (i.e. $(p, n) \leq (q, m)$ if and only if either $p < q$ or $p = q$ and $n < m$); this gives a total ordering to the set of loops γ in Γ . We will prove that $|K_\gamma| = 1$ by induction on the m-height of γ .

If $h(\gamma) = p$ then γ must be the trivial loop (with no edges) hence $|K_\gamma| = 1$ by default.

This is the base case.

Suppose $(h(\gamma), \mu(\gamma)) = (r_m, M)$ where

$$\gamma: p \rightarrow r_1 \rightarrow \dots \rightarrow r_{m-1} \rightarrow r_m \rightarrow r_{m+1} \rightarrow \dots \rightarrow r_k \rightarrow p.$$

If $r_{m-1} = r_{m+1}$ then we can factor the loop γ into $\gamma_b \cdot \gamma_m \cdot \gamma_f$ where

$$\gamma_b: p \rightarrow r_1 \rightarrow \dots \rightarrow r_{m-1},$$

and

$$\gamma_f: r_{m+1} \rightarrow r_{m+2} \rightarrow \dots \rightarrow r_k \rightarrow p,$$

and

$$\gamma_m: r_{m-1} \rightarrow r_m \rightarrow r_{m+1}.$$

But $|K_{\gamma_m}| = 1$; hence if

$$\gamma' := \gamma_b \cdot \gamma_f$$

then γ' is a loop based at p with either $h(\gamma') < r_m = h(\gamma)$ or $\mu(\gamma') = M - 1 < M = \mu(\gamma)$, and $|K_{\gamma'}| = |K_\gamma|$. Thus by induction $|K_{\gamma'}| = 1$ and we are done.

Otherwise $r_{m-1} \neq r_{m+1}$. In this case let $H = \text{span}_{\mathbb{R}}\{\alpha(\overline{r_m r_{m-1}}), \alpha(\overline{r_m r_{m+1}})\} \subset \mathbb{R}^n$ and let $(\Gamma_H^0, \alpha_H^0, \theta_H^0)$ be the corresponding 2-slice containing r_m . Let $s_0 \in V_H^0$ be the unique minimum in Γ_H^0 with respect to the induced partial ordering on V_H^0 (the non-cyclicity of (Γ, α, θ) implies that all 2-slices have a unique minimum). Then there exist ξ -oriented paths

$$\gamma_1: s_0 \rightarrow t_1 \rightarrow \dots \rightarrow t_a \rightarrow r_{m-1}$$

$$\gamma_2: s_0 \rightarrow u_1 \rightarrow \dots \rightarrow u_b \rightarrow r_{m+1}.$$

Let

$$\gamma_b: p \rightarrow r_1 \rightarrow \dots \rightarrow r_{m-1},$$

$$\gamma_m: r_{m-1} \rightarrow r_m \rightarrow r_{m+1},$$

and

$$\gamma_f: r_{m+1} \rightarrow \dots \rightarrow r_k \rightarrow p.$$

Then

$$\gamma = \gamma_b \cdot \gamma_m \cdot \gamma_f$$

and

$$|K_\gamma| = |K_{\gamma_b}| \cdot |K_{\gamma_m}| \cdot |K_{\gamma_f}|.$$

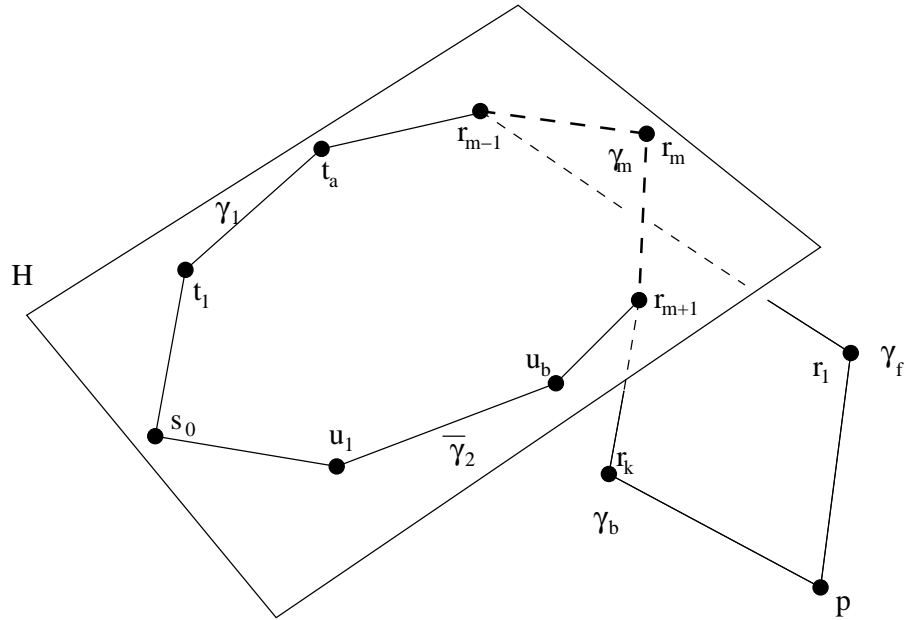

Figure 25. Decreasing the m -height of a loop on a 2-slice

By assumption we have that

$$|K_{\gamma_1}| \cdot |K_{\gamma_m}| \cdot |K_{\overline{\gamma_2}}| = 1$$

hence we can replace γ by the new loop

$$\hat{\gamma} = \gamma_b \cdot \overline{\gamma_1} \cdot \gamma_2 \cdot \gamma_f.$$

The point is that either $h(\hat{\gamma}) < h(\gamma)$ or $h(\hat{\gamma}) = h(\gamma)$ and $\mu(\hat{\gamma}) < \mu(\gamma)$ and $|K_{\hat{\gamma}}| = |K_{\gamma}|$. Hence by induction $|K_{\gamma}| = 1$. This completes the proof of Proposition 3.1.13. \square

The following theorem is an important result due to Guillemin and Zara.

Theorem 3.1.14. ([16]) *Let $(\Gamma, \alpha, \theta) \subset \mathbb{R}^n$ be any non-cyclic 1-skeleton. Then (Γ, α, θ) has the Morse package if and only if every 2-slice $(\Gamma_H^0, \alpha_H^0, \theta_H^0)$ has the Morse package.*

Remarks. *i. Guillemin and Zara prove Theorem 3.1.14 in their paper [16] for GKM 1-skeleta. Their proof is difficult and subtle and relies heavily on the fact that GKM 1-skeleta have an integral with a localization formula (note GKM 1-skeleta are always straight). It is straight forward (but tedious) to check that their proof still holds without the GKM hypotheses, using Propositions 3.1.10 and 3.1.13 above.*

ii. Theorem 3.1.14 together with Lemma 3.1.12 implies that every non-cyclic 3-independent 1-skeleton $(\Gamma, \alpha) \subset \mathbb{R}^n$ has the Morse package. In particular, the 1-skeleton of a simple d -polytope has the Morse package. See [27] for another take on this fact.

3.2 Planar 1-Skeleta

We now come to the main results of Chapter 3. By *planar 1-skeleton* we shall mean any 1-skeleton $(\Gamma, \alpha) \subset \mathbb{R}^2$. In order to understand 1-skeleta with the Morse package it suffices to understand planar 1-skeleta with the Morse package by Theorem 3.1.14. The goal of this section is to try and understand which planar 1-skeleta have the Morse package.

This section is divided into two parts. In the first part we give a geometric characterization of 3-valent planar 1-skeleta with the Morse package. We then use this characterization to construct a family of 3-valent 1-skeleta with the Morse package. In the

next section we introduce a family of (in general higher valency) 1-skeleta and prove that some of them have the Morse package while some do not.

3.2.1 The 3-Valent Case

As a first step in trying to understand planar 1-skeleta with the Morse package, we investigate the 3-valent case. Here is the main result in this direction.

Theorem 3.2.1. *Let $(\Gamma, \alpha) \subset \mathbb{R}^2$ be a 3-valent non-cyclic 1-skeleton. Then (Γ, α) has the Morse package if and only if (Γ, α) is straight.*

The following technical lemma is critical to the proof of Theorem 3.2.1.

Lemma 3.2.2. *Let $\Gamma = (V_\Gamma, E_\Gamma) := \{v \rightarrow v_1 \rightarrow \cdots \rightarrow v_N \rightarrow v\}$ be a 2-valent graph (written as a loop based at $v \in V_\Gamma$) and let $\alpha: E_\Gamma \rightarrow \mathbb{R}^2$ be any function satisfying*

- i. $\{\alpha(e) \mid e \in E_p\}$ is pairwise linearly independent for $p \in V_\Gamma$*
- ii. $\alpha(e) = -\alpha(\bar{e})$ for all $e \in E_\Gamma$.*

Let $\lambda_i \in \mathbb{R} \setminus \{0\}$ be the constants defined by the condition $\alpha(\overline{v_i v_{i-1}}) - \lambda_i \alpha(\overline{v_{i+1} v_{i+2}}) \in \text{span}_{\mathbb{R}}\{\alpha(\overline{v_i v_{i+1}})\}$. Then $\lambda_1 \cdots \lambda_N = 1$.

Proof. The trick is to compare the determinants of edges issuing from single vertex along the edges. By determinant we mean an element of the 1-dimensional vector space $\wedge^2(\mathbb{R}^2)$. Here are the details.

For each i (modulo N) we have

$$\alpha(\overline{v_i v_{i-1}}) - \lambda_i \alpha(\overline{v_{i+1} v_{i+2}}) = c_i \alpha(\overline{v_i v_{i+1}}) \tag{3.2.1}$$

for some $c_i \in \mathbb{R}$. Applying $-\wedge \alpha(\overline{v_i v_{i+1}})$ to both sides of (3.2.1) we see that

$$\alpha(\overline{v_i v_{i-1}}) \wedge \alpha(\overline{v_i v_{i+1}}) = \lambda_i \alpha(\overline{v_{i+1} v_i}) \wedge \alpha(\overline{v_{i+1} v_{i+2}}). \tag{3.2.2}$$

Inductively we find that

$$\alpha(\overline{vv_N}) \wedge \alpha(\overline{vv_1}) = \lambda_1 \cdots \lambda_N \alpha(\overline{vv_N}) \wedge \alpha(\overline{vv_1}), \quad (3.2.3)$$

hence $\lambda_1 \cdots \lambda_N = 1$ as desired. This completes the proof of Lemma 3.2.2. \square

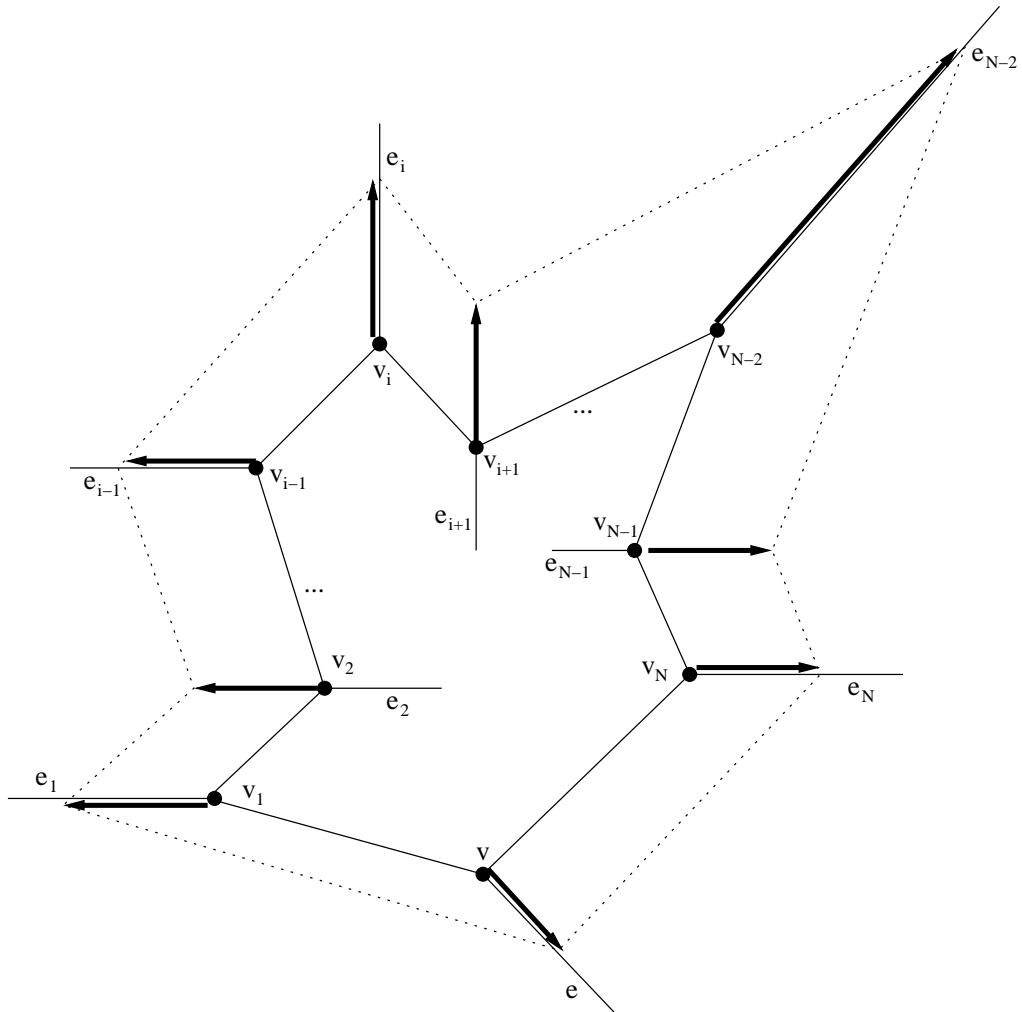

Figure 26. A “Thom-Class” on an arbitrary loop

We are now in a position to prove Theorem 3.2.1. Let $(\Gamma, \alpha) \subset \mathbb{R}^2$ be a 3-valent, non-cyclic 1-skeleton as in the statement of Theorem 3.2.1. Fix a polarizing covector $\xi \in (\mathbb{R}^2)^*$.

Proof. of Theorem 3.2.1 One direction is trivial: assuming that (Γ, α) has the Morse package, the generating class of the unique maximum (with respect to the partial order induced on V_Γ by ξ) is a non-vanishing top-class. By Proposition 3.1.10, (Γ, α) must be straight.

Conversely, assume that (Γ, α) is straight. To show that (Γ, α) has the Morse package, it suffices to show that every vertex of index 1 has a generating class. Fix a vertex $v \in V_\Gamma$ with $\text{ind}_\xi(v) = 1$. There exist two paths

$$\gamma_1: v \rightarrow u_1 \rightarrow \cdots \rightarrow u_r \rightarrow x$$

and

$$\gamma_2: v \rightarrow w_1 \rightarrow \cdots \rightarrow w_s \rightarrow x$$

that are ξ oriented and such that the sets $\{u_1, \dots, u_r\}$ and $\{w_1, \dots, w_s\}$ are disjoint. Indeed along either path, at the i^{th} step we can either augment the path with an edge leading to a higher vertex or we are at the unique highest vertex in which case we must stop. Both paths must at least meet at this vertex. Then let x be the smallest vertex where both paths meet. Let $\Gamma_v = (V_{\Gamma_v}, E_{\Gamma_v})$ denote the 2-valent graph defined to be the cycle formed by concatenating γ_1 and $\bar{\gamma}_2$. For notational convenience write

$$\gamma_1 \cdot \bar{\gamma}_2: v \rightarrow v_1 \rightarrow \cdots \rightarrow v_N \rightarrow v;$$

hence $v_1 = u_1$ and $v_N = w_s$.

Let $\lambda_i \in \mathbb{R} \setminus \{0\}$ be defined by

$$\alpha(\overline{v_i v_{i-1}}) - \lambda_i \alpha(\overline{v_{i+1} v_{i+2}}) = c_i \alpha(\overline{v_i v_{i+1}}) \quad (3.2.4)$$

for some $c_i \in \mathbb{R}$. For each $v_i \in \gamma_1 \cdot \bar{\gamma}_2$ let $e_i \in E_{v_i}$ be the edge at v_i normal to the subgraph $\gamma_1 \cdot \bar{\gamma}_2$. Let $\bar{\lambda}_i \in \mathbb{R} \setminus \{0\}$ be defined by

$$\alpha(e_i) - \bar{\lambda}_i \alpha(e_{i+1}) = k_i \alpha(\overline{v_i v_{i+1}}) \quad (3.2.5)$$

for some $k_i \in \mathbb{R}$.

Then for each $1 \leq i \leq N$ we have

$$\alpha(\overline{v_i v_{i-1}}) \cdot \alpha(e_i) \equiv (\lambda_i \bar{\lambda}_i) \alpha(\overline{v_{i+1} v_{i+2}}) \cdot \alpha(e_{i+1}) \pmod{\alpha(\overline{v_i v_{i+1}})}. \quad (3.2.6)$$

On the other hand we also have for $1 \leq i \leq N$,

$$\alpha(\overline{v_i v_{i-1}}) \cdot \alpha(e_i) \equiv (\lambda_{\overline{v_i v_{i+1}}}(\overline{v_i v_{i-1}}) \lambda_{\overline{v_i v_{i+1}}}(e_i)) \alpha(\overline{v_{i+1} v_{i+2}}) \cdot \alpha(e_{i+1}) \pmod{\alpha(\overline{v_i v_{i+1}})}. \quad (3.2.7)$$

Since the principal ideal generated by $\alpha(\overline{v_i v_{i+1}})$ is prime in S , the ring $S/\langle \alpha(\overline{v_i v_{i+1}}) \rangle$ is an integral domain, hence we conclude that

$$\lambda_i \bar{\lambda}_i = \lambda_{\overline{v_i v_{i+1}}}(\overline{v_i v_{i-1}}) \lambda_{\overline{v_i v_{i+1}}}(e_i). \quad (3.2.8)$$

Since (Γ, α) is straight, (3.2.8) implies that $\lambda_1 \bar{\lambda}_1 \cdots \lambda_N \bar{\lambda}_N = 1$. By Lemma 3.2.2 we also have that $\lambda_1 \cdots \lambda_N = 1$. Therefore we must have that $\bar{\lambda}_1 \cdots \bar{\lambda}_N = 1$. This implies that the function $\tau_v: V_\Gamma \rightarrow S^1$ defined by

$$\tau_v(q) = \begin{cases} \alpha(e) & \text{if } q = v \\ (\bar{\lambda}_i \cdots \bar{\lambda}_1) \alpha(e_i) & \text{if } q = v_i \\ 0 & \text{otherwise} \end{cases}$$

is actually an equivariant class. By construction, τ_v is a generating class for v . See Figure 3.2.1; the arrows at the vertices (in bold font) denote the values of the class at the vertices and the dotted line is meant to show that they “line up” to define a class.

This shows that (Γ, α) admits a generating family and thus completes the proof of Theorem 3.2.1. \square

As an application of Theorem 3.2.1 we give an infinite family of planar 3-valent 1-skeleta that have the Morse package.

CS-1-Skeleta

A convex polygon $P \subset \mathbb{R}^2$ containing the origin in its interior is *centrally symmetric* if $x \in P$ implies $-x \in P$. Let $P \subset \mathbb{R}^2$ be any centrally symmetric polygon and $\Gamma_P = (V, E)$ its 2-valent graph. Let $\hat{\Gamma}_P = (\hat{V}, \hat{E})$ denote the graph obtained from Γ_P by joining anti-podal vertices by edges; thus $\hat{V} = V$ and $\hat{E} = E \sqcup \{\overline{v(-v)} \mid v \in V\}$. Define

$$\hat{\alpha}_P: \hat{E} \rightarrow \mathbb{R}^2$$

by

$$\hat{\alpha}_P(e) = \begin{cases} \alpha_P(e) & \text{if } e \in E \\ -\vec{v} & \text{if } e = \overline{v(-v)} \end{cases}$$

(here we are taking $\alpha_P: E \rightarrow \mathbb{R}^2$ to be the axial function on Γ_P defined by the embedding of P). Let θ_P denote the (unique) connection on (Γ_P, α_P) . There is a unique connection $\hat{\theta}_P$ on $\hat{\Gamma}_P$ such that $\hat{\theta}_P|_E = \theta_P$. It is straightforward to check that $\hat{\alpha}_P$ defines an axial function for the pair $(\hat{\Gamma}_P, \hat{\theta}_P)$. The 3-valent 1-skeleton with connection thus obtained $(\hat{\Gamma}_P, \hat{\alpha}_P, \hat{\theta}_P) \subset \mathbb{R}^2$ is called a *CS-1-skeleton*.

Theorem 3.2.3. *CS-1-skeleta have the Morse package.*

Proof. By Theorem 3.2.1 it suffices to show that all CS-1-skeleta are straight. By Corollary 3.1.11 it suffices to show that there exist positive constants $\{c_p\}_{p \in V} \subset \mathbb{R}_+$ such that for every $\overline{pq} \in E_{\hat{\Gamma}}$ we have

$$\frac{c_q}{c_p} = \prod_{i(e)=p} \lambda_{\overline{pq}}(e).$$

By Lemma 3.1.12 $(\Gamma_P, \alpha_P, \theta_P)$ is straight hence by Corollary 3.1.11 there exist positive constants $\{c_p\}_{p \in V} \subset \mathbb{R}_+$, unique up to scaling, such that for edges $\overline{pq} \in E$,

$$\frac{c_q}{c_p} = \prod_{e \in E_p} \lambda_{\overline{pq}}(e) = \lambda_{\overline{pq}}(e),$$

where $e \in (E_P)_p$ is the unique oriented edge at p that is not \overline{pq} . We choose these constants such that $c_p = c_{-p}$ for all $p \in V_P$; we can do this by the central symmetry of P .

The claim is that this choice of constants for $(\Gamma_P, \alpha_P, \theta_P)$ will also work for $(\hat{\Gamma}_P, \hat{\alpha}_P, \hat{\theta}_P)$.

There are two types of edges to check: edges of P and “central” edges.

i. Let $\overline{pq} \in E_P$. Then we have

$$\alpha(\overline{p(-p)}) = -\vec{p}$$

and

$$\alpha(\overline{q(-q)}) = -\vec{q}.$$

Hence $\lambda_{\overline{pq}}(\overline{p(-p)}) = 1$, hence

$$\frac{c_q}{c_p} = \prod_{e \in E_P} \lambda_{\overline{pq}}(e) \cdot 1 = \prod_{e \in \hat{E}_P} \lambda_{\overline{pq}}(e)$$

ii. Now let $\overline{p(-p)} \in \hat{E}$ be a “central” edge. If $\overline{pq}, \overline{pr} \in E_P$ it follows that from central symmetry that

$$\lambda_{\overline{p(-p)}}(\overline{pq}) \cdot \lambda_{\overline{p(-p)}}(\overline{pr}) = \lambda_{\overline{p(-p)}}(\overline{pq}) \cdot \lambda_{\overline{(-p)p}}(\overline{qp}) = 1.$$

On the other hand we chose our constants so that $c_p = c_{-p}$, hence we have that

$$\lambda_{\overline{p(-p)}}(\overline{pq}) \cdot \lambda_{\overline{p(-p)}}(\overline{pr}) = 1 = \frac{c_p}{c_{(-p)}}.$$

See Figure 27.

This shows that $(\hat{\Gamma}_P, \hat{\alpha}_P, \hat{\theta}_P)$ is straight, hence has the Morse package by Theorem 3.2.1. □

As one might expect, things are more complicated in the higher valency cases.

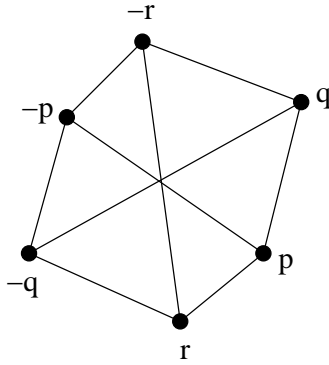

Figure 27. A CS-1-Skeleton

3.2.2 Crossed-Regular Polygons

Let $P \subset \mathbb{R}^2$ be a regular m -gon (centered at the origin) with symmetry group $I(m)$ (= the dihedral group generated by m reflections). Let $\Gamma_P = (V_P, E_P)$ denote the graph of P and define the *completion* of P to be the complete graph, K_P on the vertex set V_P : $K_P = (V_P, X_P)$ where the oriented edge set is $X_P = \{\overrightarrow{pq} \mid p, q \in V_P\}$. For each (oriented) edge $e := \overrightarrow{pq} \in X_P$ let $s_e \in I(m)$ denote the reflection across the line perpendicular to the line segment joining p to q . Define the *regular connection*, $\theta = \{\theta_e\}_{e \in X_P}$, on K_P by

$$(X_P)_p \xrightarrow{\theta_e} (X_P)_q$$

$$\overrightarrow{pr} \longrightarrow \overrightarrow{s_e(p)s_e(r)}.$$

Let $\alpha: X_P \rightarrow \mathbb{R}^2$ denote the natural axial function coming from the embedding of K_P : $\alpha(\overrightarrow{pq}) = \vec{q} - \vec{p}$. Then the triple $(K_P, \alpha, \theta) \subset \mathbb{R}^2$ is an $(m - 1)$ -valent 1-skeleton called a *complete regular m -gon*.

A *removal set* is a subset $J \subset X_P \setminus E_P$ closed under the group action:

$$g \cdot J \subset J \quad \forall g \in I(m).$$

Given a removal set J and a vertex q , define $J_q \subset (X_P)_q$ to be the subset of oriented edges

at q that lie in J , and define

$$V_{J,q} := \{x \in V_P \mid \overline{qx} \in J_q\} \subset V_P.$$

Define the graph $K_P(J) = (V_P, X_P(J)) \subset K_P$ where $X_P(J) := X_P \setminus J$. Since $\theta_{\overline{pq}}(J_P) = J_q$, the connection θ on K_P restricts to a connection θ_J on $K_P(J)$. Hence the restriction $\alpha_J = \alpha|_{X_P(J)}$ is an axial function for $K_P(J)$ and this defines a sub-skeleton $(K_P(J), \alpha_J, \theta_J) \subset (K_P, \alpha, \theta)$. The 1-skeleton $(K_P(J), \alpha_J, \theta_J) \subset \mathbb{R}^2$ is called a *crossed-regular m -gon*.

We would like to understand which crossed-regular m -gons $(K_P(J), \alpha_J, \theta_J)$ have the Morse package.

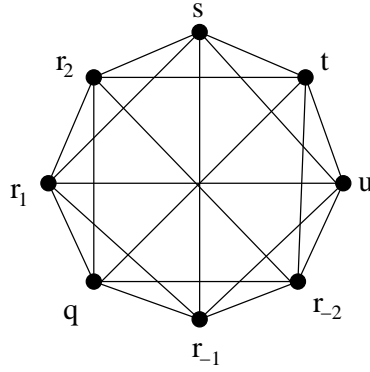

Figure 28. A Crossed-Regular 8-gon.

A subset of vertices of P , $Y \subset V_P$, is called *P -connected* if Y is the vertex set of a connected arc in P .

Now fix a covector $\xi \in (\mathbb{R}^2)^*$ such that the function

$$\langle \xi, \cdot \rangle: \mathbb{R}^2 \rightarrow \mathbb{R}$$

is injective on $V_P \subset \mathbb{R}^2$ (remember that P comes with an embedding). Then ξ plays the role of a polarizing covector, inducing a partial ordering “ \leq ” on V_P , and its own compatible Morse function inducing a total ordering “ \leq ” on V_P . As in section 1, set $\mathcal{F}_q = \{x \in V_P \mid q \leq x\}$ and $F_q = \{x \in V_P \mid q \leq x\}$.

Lemma 3.2.4. *For each vertex $q \in V_P$, F_q is P -connected.*

Proof. The unique maximum vertex with respect to the total ordering “ \leq ” can be characterized locally as follows: $q_0 \in V_P$ is the unique maximum if and only if q_0 is larger than each of its (two) neighbors (in V_P). This is a direct consequence of the convexity of P .

Let

$$\gamma_1: x_1 \rightarrow \cdots \rightarrow x_r$$

$$\gamma_2: y_1 \rightarrow \cdots \rightarrow y_s$$

be two P -connected arcs of maximal length in F_q . We will assume that γ_1 and γ_2 are distinct and derive a contradiction. If $\gamma_1 \neq \gamma_2$, then their vertex sets must be disjoint by the maximality assumption (if they were not disjoint, we could get a longer P -connected arc by concatenating γ_1 and γ_2). Hence the *unique* maximum vertex in P does not lie in γ_1 , say. By the local characterization of the unique maximum, we may assume that γ_1 is ξ -oriented in the sense that $x_i > x_{i-1}$ for $1 \leq i \leq r$ (otherwise there is an $1 \leq i \leq r-1$ such that $x_{i+1} < x_i > x_{i-1}$ which would imply that x_i is the maximum). Let $x_{r+1} \in V_P$ such that $\overline{x_r x_{r+1}} \in E_P$. Now by the maximality of γ_1 , we must have $x_{r+1} \notin F_q$ which implies that $x_{r+1} < x_r$. Hence we have $x_{r+1} < x_r > x_{r-1}$, hence x_r is the unique maximum and lies in γ_1 , a contradiction. \square

For each removal set J , and each vertex $q \in V_P$ there is a maximal P -connected set

$$Y_{J,q} \subset V_P \setminus V_{J,q}$$

that contains q . By the symmetry of P and J , there is a positive integer N_J that is independent of q , and a labelling

$$Y_{J,q} = \{r_{-N_J}, r_{-N_J+1}, \dots, r_{-1}, q, r_1, \dots, r_{N_J-1}, r_{N_J}\}$$

where $\overline{r_i r_{i+1}} \in E_P$ and $s_q(r_i) = r_{-i}$ for all i , where $s_q \in I(m)$ denotes the (unique) non-trivial stabilizer of q . In Figure 28 for example, we have $V_{J,q} = \{s, u\}$, $Y_{J,q} = \{r_{-2}, r_{-1}, q, r_1, r_2\}$. In this example $N_J = 2$.

Lemma 3.2.5. *If $q \in V_P$ is any vertex and $V_{J,q} \cap F_q = \emptyset$ then for any $z \in F_q$ we have $V_{J,z} \cap F_q = \emptyset$.*

Proof. Label

$$Y_{J,q} = \{r_{-N_J}, \dots, r_{-1}, q, r_1, \dots, r_{N_J}\}$$

$$Y_{J,z} = \{s_{-N_J}, \dots, s_{-1}, z, s_1, \dots, s_{N_J}\}$$

(recall that the symmetry of P and J guarantee that N_J is independent of q). By Lemma 3.2.4 F_q is P -connected. This implies that either $F_q = \{q\}$ (in which case the statement is vacuous) or that $|F_q| \leq N_J + 1$. Indeed if $F_q \neq \{q\}$, then q is not the unique maximum, hence r_{-1} and r_1 cannot both lie in F_q . Hence $F_q \subset \{q, r_1, \dots, r_{N_J}\}$ or $F_q \subset \{q, r_{-1}, \dots, r_{-N_J}\}$.

Since $z \in F_q$ and $Y_{J,z}$ is (by definition) P -connected, we see that $F_q \subset Y_{J,z}$ ($F_q \cap Y_{J,z}$ must be a P -connected arc of length at most $N_J + 1$), hence $F_q \cap V_{J,z} = \emptyset$. This completes the proof of Lemma 3.2.5. \square

Lemma 3.2.6. *Given a removal set $J \subset X_P \setminus E_P$, there is a unique vertex $q_J \in V_P$ satisfying*

$$i. \ V_{J,q_J} \cap F_{q_J} = \emptyset$$

$$ii. \ Y_{J,q_J} = \{r_{-N_J}, \dots, r_{-1}, q_J, r_1, \dots, r_{N_J}\} \cap F_{q_J} = \{q_J, r_1, \dots, r_{N_J}\}.$$

Proof. Choose q_J to be the $(N_J + 1)^{st}$ largest vertex with respect to “ \leq ”; that is, choose q_J so that $|F_{q_J}| = N_J + 1$. We can label

$$Y_{J,q_J} = \{r_{-N_J}, \dots, r_{-1}, q_J, r_1, \dots, r_{N_J}\}$$

so that $r_{-1} < q_J < r_1$. Then $r_1 \in F_{q_J}$ and $r_{-1} \notin F_{q_J}$. By Lemma 3.2.4 F_{q_J} is P -connected, hence F_{q_J} and the P -connected set $\{q_J, r_1, \dots, r_{N_J}\}$ must coincide. This completes the proof of Lemma 3.2.6. \square

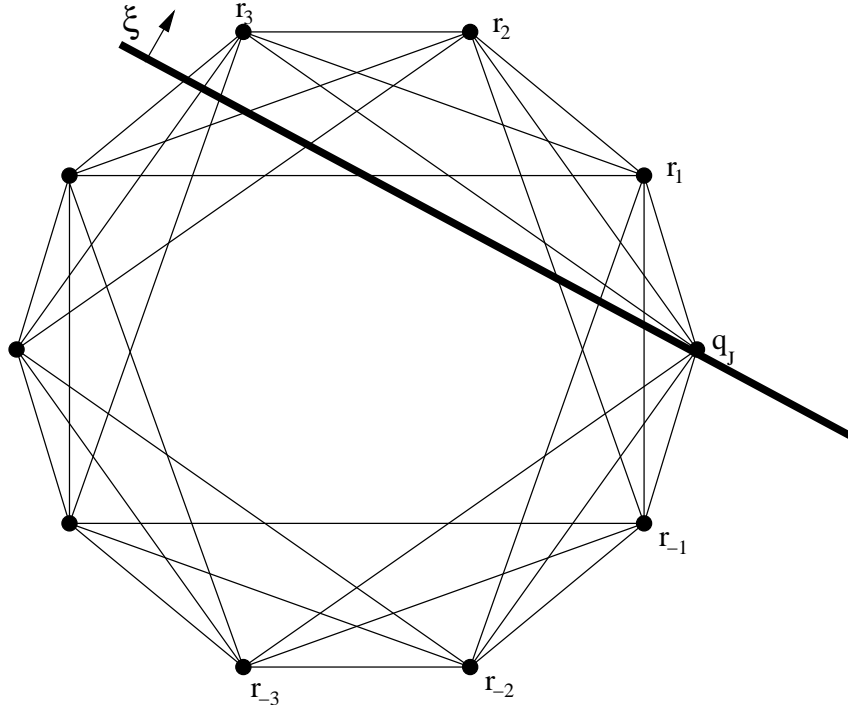

Figure 29. The unique vertex q_J

A removal set J is called *outer* if the set $V_{J,q}$ is P -connected, for all $q \in V_P$. The resulting 1-skeleton $(K_P(J), \alpha_J, \theta_J)$ is called an *outer* crossed-regular m -gon. Note that if J is outer, then $V_P = Y_{J,q} \sqcup V_{J,q}$.

It is straight forward to construct a generating family for the complete regular m -gon (K_P, α, θ) . In order to understand the equivariant cohomology ring of $(K_P(J), \alpha_J, \theta_J)$, it is useful to think of the crossed-regular m -gon as a sub-skeleton of (K_P, α, θ) . For any removal set $J \subset X_P \setminus E_P$, there is a Thom class $\tau_J \in H(K_P, \alpha)$, multiplication by which gives an inclusion

$$H(K_P(J), \alpha_J) \xrightarrow{\tau_J} H(K_P, \alpha).$$

Also since $(K_P(J), \alpha_J, \theta_J) \subset (K_P, \alpha, \theta)$ is a sub-skeleton, there is an inclusion morphism that induces a restriction map on equivariant cohomology rings

$$H(K_P, \alpha) \xrightarrow{\iota^*} H(K_P(J), \alpha_J).$$

Furthermore since the group $I(m)$ acts on $(K_P(J), \alpha_J, \theta_J)$ via 1-skeleton automorphisms, there is an induced action of the group $I(m)$ on $H(K_P(J), \alpha_J)$; we will denote this action by $g \star f$ for $f \in H(K_P(J), \alpha_J)$ and $g \in I(m)$.

We have the following result, which is a first step in understanding the Morse package for crossed-regular polygons.

Theorem 3.2.7. *Outer crossed-regular m -gons have the Morse package.*

Proof. The idea of the proof is straight forward: view $(K_P(J), \alpha_J, \theta_J)$ as a sub-skeleton of (K_P, α, θ) and use symmetry and the fact that (K_P, α, θ) admits a generating family to construct a generating family for $(K_P(J), \alpha_J, \theta_J)$. Let $q \in V_P$ be any vertex. We will show that q admits a pseudo-generating class. There are three cases to consider.

- i. $\langle \xi, \alpha(e) \rangle > 0$ for each $e \in J_q$: In this case we let τ_q be the generating class for q in $H(K_P, \alpha)$. Then its restriction $\iota^* \tau_q \in H(K_P(J), \alpha_J)$ is a pseudo-generating class: $\text{supp}(\iota^* \tau_q) \subset F_q$ and

$$\iota^* \tau_q(q) = \prod_{e \in X(J)_q^-} \alpha(e).$$

See Figure 31.

- ii. $\langle \xi, \alpha(e) \rangle < 0$ for each $e \in J_q$: In this case we let τ_q be the generating class for q in $H(K_P, \alpha)$. Note that the support of τ_q is contained in F_q and that in this case $V_{J,q} \cap F_q = \emptyset$. Hence by Lemma 3.2.5, $V_{J,z} \cap F_q = \emptyset$ for each $z \in F_q$. Hence

$$\tau_q(z) = K_z \cdot \prod_{e \in J_z} \alpha(e) \tag{3.2.9}$$

for some $K_z \in S$ depending on $z \in F_q$. The claim now is that the function $\tilde{\tau}_q: X(J) \rightarrow S$ defined by

$$\tilde{\tau}_q(z) = \begin{cases} K_z & \text{if } z \in F_q \\ 0 & \text{otherwise} \end{cases}$$

is actually an equivariant class on $(K_P(J), \alpha_J)$. The point is that for $\overline{zz'} \in X(J)$ we have

$$\tau_q(z) - \tau_q(z') \equiv 0 \pmod{\alpha(\overline{zz'})}$$

and

$$\prod_{e \in J_z} \alpha(e) - \prod_{e' \in J_{z'}} \alpha(e') \equiv 0 \pmod{\alpha(\overline{zz'})}.$$

Since $\prod_{e \in J_z} \alpha(e) \not\equiv 0 \pmod{\alpha(\overline{zz'})}$ we must have that

$$K_z - K_{z'} \equiv 0 \pmod{\alpha(\overline{zz'})}$$

as well. Thus $\tilde{\tau}_q$ is an equivariant class. Clearly $\text{supp}(\tilde{\tau}_q) \subset F_q$. Finally note that $K_q = \prod_{e \in X(J)_q} \alpha_J(e)$ by (3.2.9), since τ_q is a generating class for q (in (K_P, α)); thus $\tilde{\tau}_q$ is a generating class for q on $(K_P(J), \alpha_J)$. See Figure 31.

- iii. $\langle \xi, \alpha(e_1) \rangle > 0 > \langle \xi, \alpha(e_2) \rangle$ for some $e_1, e_2 \in J_q$: In this case we appeal to the symmetry of $(K_P(J), \alpha_J, \theta_J)$ and Lemma 3.2.6. Let $q_J \in V_P$ be the unique vertex as in Lemma 3.2.6. By symmetry there exists a group element $g \in I(m)$ such that $g(q_J) = q$. Since $I(m)$ is acting by graph morphisms (in fact, $I(m)$ acts by 1-skeleton morphisms), g takes the P -connected subset

$$F_{q_J} \subset Y_{J, q_J} \subset V_P \setminus V_{J, q_J}$$

to a P -connected subset

$$g(F_{q_J}) \subset Y_{J, q} \subset V_P \setminus V_{J, q}.$$

By Lemma 3.2.6, $|g(F_{q_J})| = |F_{q_J}| = N_J + 1$. Since in this case we have $V_{J,q} \cap F_q \neq \emptyset$, we must have $|F_q| > N_J + 1$. The claim is that we may assume that the P -connected set $g(F_{q_J})$ lies in F_q . To see this write the sets

$$Y_{J,q_J} = \{r_{-N_J}, \dots, r_{-1}, q_J, r_1, \dots, r_{N_J}\}$$

and

$$Y_{J,q} = \{s_{-N_J}, \dots, s_{-1}, q, s_1, \dots, s_{N_J}\}.$$

By Lemma 3.2.6 we have that

$$Y_{J,q_J} \cap F_{q_J} = \{q_J, r_1, \dots, r_{N_J}\}.$$

Thus since $g(q_J) = q$, the set $g(F_{q_J}) \cap Y_{J,q}$ must be a P connected arc lying on one side of q or the other; by reflecting about q , we may assume that $g(F_{q_J}) \cap Y_{J,q} = \{q, s_1, \dots, s_{N_J}\} \subset F_q$.

Hence $g(q_J) = q$ and $g(F_{q_J}) \subset F_q$. By case 2, there is a class $\tilde{\tau}_{q_J} \in H(K_P(J), \alpha_J)$ whose support lies in F_{q_J} and whose value at q_J is

$$\tau_{q_J}(q_J) = \prod_{e \in X(J)_{\bar{q}_J}} \alpha(e).$$

Set $\tau_q = g \star \tilde{\tau}_{q_J}$. Then

$$\text{supp}(\tau_q) \subset g(F_{q_J}) \subset F_q$$

and

$$\tau_q(q) = \prod_{e \in X(J)_{\bar{q}_J}} g(\alpha(e)) = \prod_{e \in X(J)_{\bar{q}}} \alpha(e);$$

to see the second equality, note that $X(J)_{\bar{q}_J} = \{\overline{q_J x} \mid x \in Y_{J,q_J} \setminus F_{q_J}\}$. Since $g(F_{q_J}) \subset F_q$ and $g(Y_{J,q_J}) = Y_{J,q}$, it follows that $g(Y_{J,q_J} \setminus F_{q_J}) = Y_{J,q} \setminus F_q$, hence that $g(X(J)_{\bar{q}_J}) = X(J)_{\bar{q}}$. Thus τ_q is a pseudo-generating class for q . See Figure 31

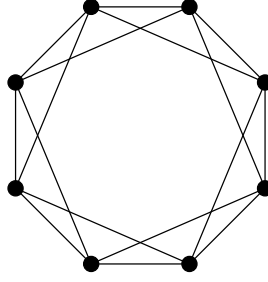

Figure 30. An outer crossed-regular 8-gon.

Thus we have shown that every vertex has a pseudo generating class, hence $(K_P(J), \alpha_J, \theta_J)$ has the Morse package. This completes the proof of Theorem 3.2.7. \square

Set $\nu_J := |V_{J,q}|$. By symmetry, ν_J , like N_J , is independent of q . We have the following corollary to the proof of Theorem 3.2.7.

Corollary 3.2.8. *The combinatorial Betti numbers for an outer crossed-regular m -gon $(K_P(J), \alpha_J, \theta_J)$ satisfy the following:*

$$b_i(K_P(J), \alpha_J) = \begin{cases} 1 & \text{if } 0 \leq i \leq N_J - 1 \\ \nu_J + 1 & \text{if } i = N_J \\ 1 & \text{if } N_J + 1 \leq i \leq 2N_J \end{cases}$$

Proof. We start with the fact that $b_i(K_P, \alpha) = 1$ for $0 \leq i \leq m - 1$. From the proof of Theorem 3.2.7 we see that

$$b_i(K_P, \alpha) = b_i(K_P(J), \alpha_J)$$

for $0 \leq i \leq N_J - 1$; vertices contributing to $b_i(K_P(J), \alpha(J))$ here correspond to those vertices in Case 1. Also we have

$$b_{i+\nu_J}(K_P, \alpha) = b_i(K_P(J), \alpha_J)$$

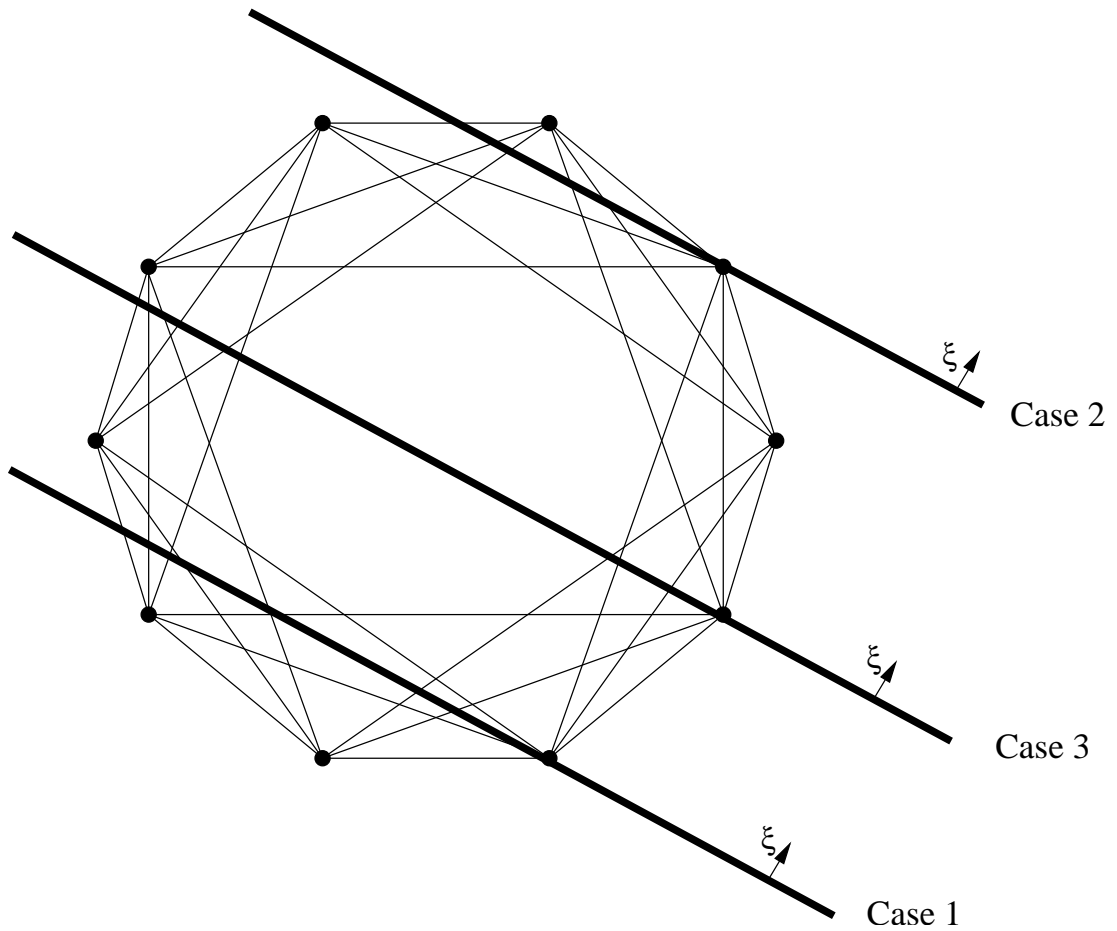

Figure 31. The 3 cases

for $N_J + 1 \leq i \leq 2N_J$; vertices contributing to $b_i(K_P(J), \alpha(J))$ here correspond to those vertices in Case 2. Finally the middle Betti number

$$b_{N_J}(K_P(J), \alpha_J) = m - 2N_J = (2N_J + 1 + v_J) - 2N_J = v_J + 1.$$

This completes the proof of Corollary 3.2.8. □

Crossed-regular polygons provide a large source of interesting examples of *straight* planar 1-skeleta (they are GKM). Many of them have the Morse package, but some do not. For example, the 4-valent crossed-regular 7-gon shown in Figure 32 does *not* have the Morse package.

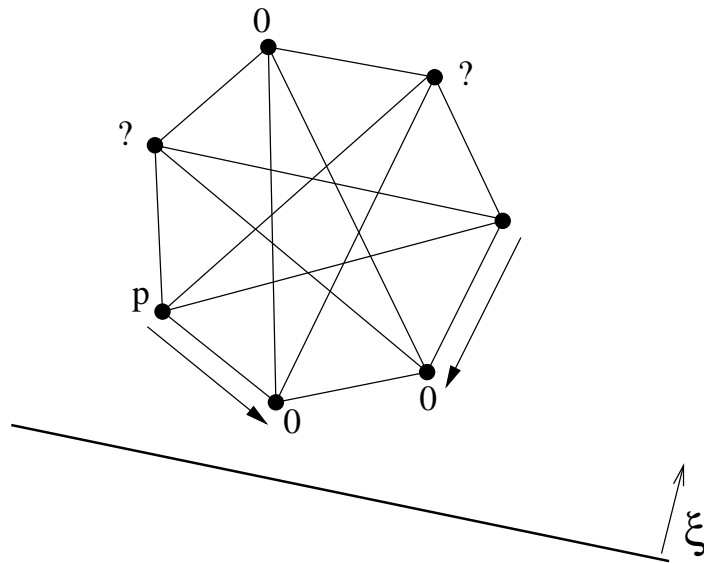

Figure 32. 4-valent, Straight, Non-Morse.

The crossed-regular 7-gon in Figure 32 is polarized by ξ . The arrows indicate an attempt to find a generating class (of degree one) for the vertex p . The value of such a class, if it exists, at each vertex is completely determined by its value at p . The vertices with question marks indicate where we get stuck.

3.3 Concluding Remarks

We end this chapter with some open questions and problems. Say that a 1-skeleton $(\Gamma, \alpha) \subset \mathbb{R}^n$ is *Cohen-Macaulay* if $H(\Gamma, \alpha)$ is a free $S = \text{Sym}(\mathbb{R}^n)$ -module.

Question. *Which 1-skeleta are Cohen-Macaulay?*

In this thesis we have followed Guillemin and Zara's lead by studying 1-skeleta with the Morse package. As we have seen in section 1, 1-skeleta with the Morse package are Cohen-Macaulay. By Guillemin and Zara's Theorem 3.1.14, one understands which 1-skeleta have the Morse package if one understands which *planar* 1-skeleta have the

Morse package.

Question. *Which planar 1-skeleta have the Morse package?*

We showed in Section 2 that our straight-ness condition is equivalent to the Morse package in the 3-valent case. However the 1-skeleton shown in Figure 32 shows that straight-ness is not a sufficient condition for the Morse package, even in the 4-valent case.

Problem. *Classify planar k -valent 1-skeleta with the Morse package for $k \geq 4$.*

It may be enlightening (and easier) to first deal with the crossed-regular polygon case.

Problem. *Classify crossed-regular polygons that have the Morse package.*

CHAPTER 4

STRONG LEFSCHETZ PROPERTIES

We continue our study of the cohomology rings associated to a 1-skeleton. In this chapter we study the strong Lefschetz properties of the ordinary cohomology ring of a 1-skeleton. In contrast to the previous chapter, in this chapter we are interested in the *multiplicative* structure of the *ordinary* cohomology ring. We will however find it useful to refer back to the equivariant cohomology ring, especially when we discuss various decomposition theorems.

The study of the strong Lefschetz property for rings in general is motivated largely by the hard Lefschetz theorem in algebraic geometry. In certain cases when a 1-skeleton comes from a GKM T -manifold, we can appeal to the hard Lefschetz theorem to deduce that its cohomology ring has the strong Lefschetz property. One would like to find an alternative proof of this fact that does not appeal to the hard Lefschetz theorem. Such an alternative proof would (hopefully) have the added benefit of extending such results to a class of 1-skeleta beyond those coming from GKM T -manifolds.

We give a couple of results in this direction in the way of “Lefschetz constructions”. By a construction on 1-skeleta, we mean some operation that takes two 1-skeleta and somehow produces a new 1-skeleta; the product and blow-up construction of Chapter 2 are examples and we introduce another one here called the fiber bundle, due to Guillemin, Sabatini, and Zara. The two main results of this chapter are algebraic in nature. One

implies that if the base and the fiber of a fiber bundle have the Lefschetz package, then the total space also has the Lefschetz package. The other implies that if a 1-skeleton and a (level) sub-skeleton both have the Lefschetz package, then the blow-up of the 1-skeleton along the sub-skeleton also has the Lefschetz package. As an application, one can apply the fiber bundle ideas to the theory of finite reflection groups and their coinvariant rings; the result is a new conceptual proof (applicable in most types) of the fact that the coinvariant ring of a finite reflection group has the strong Lefschetz property.

This chapter is divided into five sections. In Section 1, we give the preliminary definitions, and attempt to give some motivation for studying rings with the strong Lefschetz property. In Section 2 we define the notion of a fiber bundle of 1-skeleta and state a decomposition result of Guillemin, Sabatini, and Zara. We then state and prove one of our main algebraic results; this will imply that the fiber bundle is a Lefschetz construction. In Section 3 we briefly review the blow-up construction (from Chapter 2) and prove a decomposition result for the cohomology ring of the blow-up due to Guillemin and Zara. We then state and prove our other main algebraic result; this will imply that the blow-up is a Lefschetz construction. In Section 4 we give some of the basic facts in the theory of root systems and finite reflection groups and their coinvariant rings. We then show how to construct a 1-skeleton from a root system and its finite reflection group and give a map explicitly relating the coinvariant ring of the finite reflection group to the cohomology ring of the associated 1-skeleton. We then proceed (using the language of finite reflection groups and coinvariant rings) to use the fiber bundle ideas above to show that the coinvariant ring has the strong Lefschetz property (for most finite reflection groups). In Section 5 we give a few concluding remarks.

4.1 Preliminaries and Motivation

Let R be an \mathbb{N} -graded Artinian \mathbb{R} algebra; that is

$$R = \bigoplus_{i \in \mathbb{N}} R^i$$

is a graded ring with $R^0 = \mathbb{R}$ and $R^i = 0$ for all $i > d$ for some $d < \infty$. We can therefore write

$$R = \bigoplus_{i=0}^d R^i$$

where $d = \max\{i \in \mathbb{N} \mid R^i \neq 0\}$. We say that R is *symmetric* if $\dim_{\mathbb{R}} R^i = \dim_{\mathbb{R}} R^{d-i}$ for each i . Given an element $l \in R^1$, multiplication defines linear maps

$$\begin{aligned} R^i &\xrightarrow{l} R^{i+1} \\ x &\longrightarrow lx. \end{aligned}$$

We say that $l \in R^1$ is a *strong Lefschetz element* if the maps

$$l^{d-2i} : R^i \rightarrow R^{d-i}$$

are isomorphisms for $0 \leq i \leq \lfloor \frac{d}{2} \rfloor$. A very simple, but fundamental example is the ring $\mathbb{R}[Y]/\langle Y^n \rangle$ for $n \geq 0$ (with the usual grading). Here a strong Lefschetz element is given by $Y \in (\mathbb{R}[Y]/\langle Y^n \rangle)^1$.

Let $(\Gamma, \alpha) \subset \mathbb{R}^n$ be a d -valent 1-skeleton with equivariant cohomology ring $H(\Gamma, \alpha)$ and ordinary cohomology ring $\overline{H(\Gamma, \alpha)}$ and let $S \hookrightarrow H(\Gamma, \alpha)$ denote the polynomial ring on $(\mathbb{R}^n)^*$ included as the constant functions on V_Γ .

$\overline{H(\Gamma, \alpha)}$ is an \mathbb{N} -graded Artinian \mathbb{R} -algebra. Indeed, $\overline{H(\Gamma, \alpha)}$ is an \mathbb{N} -graded \mathbb{R} -algebra since it is the quotient of an \mathbb{N} -graded S -algebra by the ideal generated by the unique homogeneous maximal ideal $S^+ \subset S$. Furthermore it is finitely generated since it is the quotient of a finitely generated S -module.

We are interested in finding conditions on a 1-skeleton $(\Gamma, \alpha) \subset \mathbb{R}^n$ that guarantee the cohomology ring $\overline{H(\Gamma, \alpha)}$ has the strong Lefschetz property. We will say that a 1-skeleton has the *Lefschetz package* if its cohomology ring has the strong Lefschetz property.

The study of the strong Lefschetz property of graded rings is rooted in the study of the topology of algebraic varieties. A deep theorem in algebraic geometry implies that the cohomology rings of certain algebraic varieties have the strong Lefschetz property. The theorem is named in honor of Solomon Lefschetz and is aptly called “the hard Lefschetz theorem”.

Theorem 4.1.1. (*hard Lefschetz*) *Let X be a smooth projective algebraic variety over \mathbb{C} and let $H(X; \mathbb{R})$ denote the (topological) cohomology ring of X with coefficients in \mathbb{R} . Let $\omega \in H^2(X; \mathbb{R})$ denote the cohomology class of a smooth hyperplane section. Let*

$$L_X: H^i(X; \mathbb{R}) \rightarrow H^{i+2}(X; \mathbb{R})$$

denote the linear map “cup-product with ω ”. Then for $0 \leq i \leq d$, where $\dim(X) = d$ the map

$$L_X^{d-i}: H^i(X; \mathbb{R}) \rightarrow H^{2d-i}(X; \mathbb{R})$$

is an isomorphism.

For more details on this theorem and its history see Messing’s article [23]. Theorem 4.1.1 can be used to show that certain 1-skeleta have the strong Lefschetz package. For example suppose that X is a smooth projective *toric* variety of $\dim(X) = d$ (in particular X is a GKM T -manifold). Then X is uniquely determined by a simplicial fan $\Delta(X) \subset (\mathbb{R}^d)^*$ and if we fix an embedding $X \hookrightarrow \mathbb{P}^N$, this uniquely determines a d -polytope $P \subset \mathbb{R}^d$ whose inner normal fan is $\Delta(X)$. Let $(\Gamma_P, \alpha_P) \subset \mathbb{R}^d$ be the d -valent 1-skeleton of the simple d -polytope P . One can show that the cohomology ring $H(X; \mathbb{R})$ is isomorphic to

the cohomology ring $\overline{H(\Gamma_P, \alpha_P)}$ via a natural degree-halving map:

$$H^{2^*}(X; \mathbb{R}) \xrightarrow{\cong} \overline{H^*(\Gamma_P, \alpha_P)}.$$

Let $\omega \in H^2(X; \mathbb{R})$ be the cohomology class of a smooth hyperplane section as in Theorem 4.1.1 and let $l \in \overline{H^1(\Gamma_P, \alpha_P)}$ be the corresponding class on (Γ_P, α_P) . Since the cohomology of X vanishes in odd degree we can rewrite the statement of Theorem 4.1.1 as the map

$$L_X^{d-2i} : H^{2i}(X; \mathbb{R}) \rightarrow H^{2d-2i}(X; \mathbb{R})$$

is an isomorphism for $0 \leq i \leq \lfloor \frac{d}{2} \rfloor$.

Then we have the commutative diagram

$$\begin{array}{ccc} H^{2i}(X; \mathbb{R}) & \xrightarrow{\cong} & \overline{H^i(\Gamma_P, \alpha_P)} \\ L_X^{d-2i} \downarrow & & \downarrow l^{d-2i} \\ H^{2d-2i}(X; \mathbb{R}) & \xrightarrow{\cong} & \overline{H^{d-i}(\Gamma_P, \alpha_P)}; \end{array}$$

this shows that (Γ_P, α_P) has the strong Lefschetz package. For more details on the correspondence between toric varieties and polytopes, see [9].

More generally if M is a GKM T -manifold that has the structure of a projective variety over \mathbb{C} for which the T action is linear algebraic, then M will be equivariantly formal in the sense of Goresky, Kottwitz and MacPherson, hence, by a theorem in [10] (Theorem 7.2, page 44) $H^{2^*}(M; \mathbb{R}) \cong \overline{H^*(\Gamma, \alpha)}$. In this case we can also apply Theorem 4.1.1 to deduce that (Γ, α) has the Lefschetz package.

The above argument for toric varieties is essentially the one used by Stanley in [26] to prove the “necessity” direction of McMullen’s celebrated g -conjecture (g -theorem now) on the face numbers of simple polytopes. An important point is that the 1-skeleton of a GKM T -manifold is necessarily integral, meaning that the axial function takes values in some integral lattice. In order to deduce the result for *all* simple polytopes, Stanley had to give some deformation arguments, since all simple polytopes are not integral *á priori*.

See [26] for more details. Later McMullen gave a different proof of the same result in [22]. Essentially McMullen showed that the 1-skeleton (Γ_P, α_P) of a simple d -polytope P has the strong Lefschetz package without appealing the Theorem 4.1.1, although the language he used differs from ours here (for instance there is no mention of “1-skeleta” or “cohomology rings” in his work). Timorin later gave a simplified version of McMullen’s proof in his paper [27]. One nice feature about McMullen’s argument is that it holds for *all* simple polytopes, integral or not. In particular McMullen’s result holds for simple polytopes that do not come from any T -space. This can be considered the starting point of the investigations in this chapter. To what extent does the strong Lefschetz property hold for more general 1-skeleta, rational or not? One approach that has been fruitful is finding so-called Lefschetz constructions on 1-skeleta.

4.2 Fiber Bundles

In this section we introduce the general notion of a fiber-bundle over a 1-skeleton. Guillemin, Sabatini and Zara introduced and studied the notions of fibrations and fiber bundles of (GKM) 1-skeleta in [28]; the definitions here are, for the most part, due to them. We will try to follow their notation. We will however drop the “GKM” assumption.

First we recall the definition of a morphism of 1-skeleta with connections. Let $(\Gamma, \alpha, \theta) \subset \mathbb{R}^n$ and $(\Gamma', \alpha', \theta') \subset \mathbb{R}^m$ be 1-skeleta with connections.

Definition 4.2.1. *A morphism of 1-skeleta with connections is a pair*

$$\pi = (\pi_G, \pi_L): (\Gamma, \alpha, \theta) \rightarrow (\Gamma', \alpha', \theta')$$

where

- i. $\pi_G: V_\Gamma \sqcup E_\Gamma \rightarrow V_{\Gamma'} \sqcup E_{\Gamma'}$ is a morphism of graphs (“ G ” for “graph”)

ii. $\pi_L: (\mathbb{R}^n)^* \rightarrow (\mathbb{R}^m)^*$ is a linear map (“L” for “linear”) making the following diagram commute:

$$\begin{array}{ccc} \mathbb{R}^m & \xrightarrow{(\pi_L)^*} & \mathbb{R}^n \\ \alpha' \uparrow & & \uparrow \alpha \\ E_{\Gamma'} & \xleftarrow{\pi_G} & \pi_G^{-1}(E_{\Gamma}') := E_{\Gamma}^h \end{array}$$

iii. θ sends horizontal edges to horizontal edges (i.e. $\theta_{\overline{pq}}((E_{\Gamma}^h)_p) \subseteq (E_{\Gamma}^h)_q$ for all $\overline{pq} \in E_{\Gamma}$) and along horizontal edges $\overline{pq} \in E_{\Gamma}^h$ the following diagram commutes:

$$\begin{array}{ccc} (E_{\Gamma}^h)_p & \xrightarrow{\pi_G} & (E_{\Gamma'})_{\pi_G(p)} \\ \theta_{\overline{pq}} \downarrow & & \downarrow \theta'_{\pi_G(\overline{pq})} \\ (E_{\Gamma}^h)_q & \xrightarrow{\pi_G} & (E_{\Gamma'})_{\pi_G(q)} \end{array}$$

We say that π is an isomorphism (of 1-skeleta with connections) if the maps π_G and π_L are both bijective. In this case there is a uniquely determined morphism

$$\hat{\pi} = (\hat{\pi}_G, \hat{\pi}_L): (\Gamma', \alpha', \theta') \rightarrow (\Gamma, \alpha, \theta)$$

where $\hat{\pi}_G = \pi_G^{-1}$ and $\hat{\pi}_L = \pi_L^{-1}$. The morphism $\hat{\pi}$ is called the inverse of π and we write $\hat{\pi} = \pi^{-1}$.

Given a totally geodesic sub-skeleton $(\Gamma'_0, \alpha'_0, \theta'_0) \subset (\Gamma', \alpha', \theta')$ we can look at the *pre-image* of the graph Γ'_0 under π_G ; that is the sub-graph $\pi_G^{-1}(\Gamma'_0) \subset \Gamma$. Without any further restrictions on the morphism π , this sub-graph need not be the graph of a totally geodesic sub-skeleton.

Definition 4.2.2. A morphism of 1-skeleta with connections

$$\pi = (\pi_G, \pi_L): (\Gamma, \alpha, \theta) \rightarrow (\Gamma', \alpha', \theta')$$

is called a fibration of 1-skeleta with connections if

i. $\pi_G: (E_\Gamma^h)_p \rightarrow (E_{\Gamma'})_{\pi_G(p)}$ is bijective for every $p \in V_\Gamma$

ii. $\mathbb{R}^m = \mathbb{R}^n$ and π_L is the identity map.

iii. For vertical edges $\overline{pq} \in E_\Gamma^v$ where $\pi_G(p) = r = \pi_G(q)$, the map $\theta_{\overline{pq}}: (E_\Gamma^h)_p \rightarrow (E_\Gamma^h)_q$ makes the following diagram commutes:

$$\begin{array}{ccc}
 (E_\Gamma^h)_p & & \\
 \downarrow \theta_{\overline{pq}} & \searrow \pi_G & \\
 & \cong & (E_{\Gamma'})_r \\
 & \nearrow \pi_G & \\
 (E_\Gamma)_q & &
 \end{array}$$

As the name suggests, the conditions on a fibration are sufficient to ensure that the pre-image of a sub-skeleton is a sub-skeleton. We state this as a theorem.

Theorem 4.2.3. *Let $\pi: (\Gamma, \alpha, \theta) \rightarrow (\Gamma', \alpha', \theta')$ be a fibration of 1-skeleta with connections. Let $(\Gamma'_0, \alpha'_0, \theta'_0) \subset (\Gamma', \alpha', \theta')$ be a totally geodesic sub-skeleton. Then the pre-image sub-graph*

$$\Gamma_0 := \pi^{-1}(\Gamma'_0) \subset \Gamma$$

has constant valency and is the graph of a totally geodesic sub-skeleton $(\Gamma_0, \alpha_0, \theta_0) \subset (\Gamma, \alpha, \theta)$.

Proof. Set $\Gamma_0 = (V_0, E_0)$. We want to show that $|(E_0)_p|$ is independent of the vertex $p \in V_0$.

For all vertices $r \in V_\Gamma$ we have $(E_\Gamma)_r = (E_\Gamma^h)_r \sqcup (E_\Gamma^v)_r$ and, if we set $r' := \pi_G(r)$, then by condition (i) in Definition 4.2.2 the map $\pi_G: (E_\Gamma^h)_r \rightarrow (E_{\Gamma'})_{r'}$ is bijective. For $r' \in V_{\Gamma'_0}$, set $(E_0^h)_r := (\pi_G|_r)^{-1}((E_{\Gamma'_0})_{r'})$. Then for all vertices $r \in V_{\Gamma_0}$ we have

$$(E_0)_r = (E_0^h)_r \sqcup (E_\Gamma^v)_r. \quad (4.2.1)$$

Now

$$|(E_0^h)_r| = (\text{valency of } \Gamma'_0) \quad (4.2.2)$$

and

$$|(E_\Gamma^v)_r| = (\text{valency of } \Gamma) - (\text{valency of } \Gamma'). \quad (4.2.3)$$

Combining (4.2.2) and (4.2.3) with (4.2.1), we see that Γ_0 must have constant valency.

Now we want to show that the connection θ on Γ restricts to give a connection θ_0 on Γ_0 . Let $\overline{pq} \in E_0$ be any edge in Γ_0 . We need to show that

$$\theta_{\overline{pq}}((E_0)_p) = (E_0)_q. \quad (4.2.4)$$

By condition (iii) of Definition 4.2.1 we have that

$$\theta_{\overline{pq}}((E_\Gamma^h)_p) \subset (E_\Gamma^h)_q.$$

Since $\theta_{\overline{pq}}: (E_\Gamma)_p \rightarrow (E_\Gamma)_q$ is bijective and $|(E_\Gamma^h)_p| = |(E_\Gamma^h)_q|$ we must in fact have

$$\theta_{\overline{pq}}((E_\Gamma^h)_p) = (E_\Gamma^h)_q,$$

and hence we must also have

$$\theta_{\overline{pq}}((E_\Gamma^v)_p) = (E_\Gamma^v)_q \quad (4.2.5)$$

for all $\overline{pq} \in E_{\Gamma_0}$.

By (iii) in Definition 4.2.1, we have the commutative diagram

$$\begin{array}{ccc} (E_0^h)_p & \xrightarrow{\pi_G} & (E_{\Gamma_0'}^h)_{\pi_G(p)} \\ \theta_{\overline{pq}} \downarrow & & \downarrow \theta'_{\pi_G(\overline{pq})} \\ (E_0^h)_q & \xrightarrow{\pi_G} & (E_{\Gamma_0'}^h)_{\pi_G(q)} \end{array}$$

for $\overline{pq} \in E_\Gamma^h$. Thus $\theta_{\overline{pq}}((E_0^h)_p) = (E_0^h)_q$ for all $\overline{pq} \in E_0^h$. For $\overline{pq} \in E_\Gamma^v$ we must also have

$$\theta_{\overline{pq}}((E_0^h)_p) = (E_0^h)_q \quad (4.2.6)$$

by condition (iii) in Definition 4.2.2. Combining (4.2.5) and (4.2.6) with (4.2.1) yields (4.2.4), as desired. \square

Theorem 4.2.3 shows that in particular, the *fibers* $\pi_G^{-1}(p') := \Gamma^{p'} \subset \Gamma$ are totally geodesic. For each $p' \in V_{\Gamma'}$ let $(\Gamma^{p'}, \alpha^{p'}, \theta^{p'}) \subset (\Gamma, \alpha, \theta)$ denote the sub-skeleton on the graph $\pi_G^{-1}(p') \subset \Gamma$; for short we write $\pi^{-1}(p') \subset (\Gamma, \alpha, \theta)$.

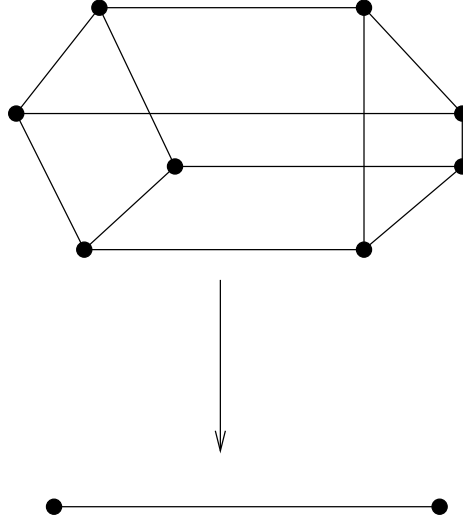

Figure 33. a fibration

Figure 33 shows a fibration over a single edge; its fibers are the quadrilaterals shown on either end.

Now we impose further restrictions (following Guillemin, Sabatini and Zara) that allow us to “transport” fibers along paths in the base. This brings us to the notion of a fiber bundle of 1-skeleta.

Definition 4.2.4. A morphism $\pi: (\Gamma, \alpha, \theta) \rightarrow (\Gamma', \alpha', \theta')$ is a fiber bundle of 1-skeleta with connections (over $(\Gamma', \alpha', \theta')$) if

- i. π is a fibration
- ii. for every edge $e' := \overline{p'q'} \in E_{\Gamma'}$ there are isomorphisms of 1-skeleta with connections

$$\Psi_{e'} = ((\Psi_{e'})_G, (\Psi_{e'})_L): \pi^{-1}(p') \rightarrow \pi^{-1}(q')$$

such that for each vertex $p \in \pi_G^{-1}(p') \cap V_\Gamma$, if $q = (\Psi_{e'})_G(p) \in \pi_G^{-1}(q')$ then $\overline{pq} \in (E_\Gamma^h)_p$.

The isomorphisms $\{\Psi_{e'}\}_{e' \in E_{\Gamma'}}$ are called transition morphisms of the fiber bundle π .

For each $p' \in V_{\Gamma'}$ let

$$i_{p'} : \pi^{-1}(p') \hookrightarrow (\Gamma, \alpha, \theta)$$

denote the natural inclusion morphism. We will express a fiber bundle of 1-skeleta in the “traditional” notation:

$$\begin{array}{ccc} \pi^{-1}(p') & \xrightarrow{i_{p'}} & (\Gamma, \alpha, \theta) \\ & & \downarrow \pi \\ & & (\Gamma', \alpha', \theta'). \end{array}$$

Here $\pi^{-1}(p')$ is called the *fiber* over p' , (Γ, α, θ) is called the *total space* and $(\Gamma', \alpha', \theta')$ is called the *base* of the fiber bundle π .

Remark. Definitions 4.2.2 and 4.2.4 are due for the most part to Guillemin, Sabatini and Zara. We say “for the most part” here because in [28], they work only with GKM 1-skeleta. Also condition (iii) in Definition 4.2.2 is not mentioned in [28]. However it is not difficult to see that given a fibration of 1-skeleta with connections $\pi : (\Gamma, \alpha, \theta) \rightarrow (\Gamma', \alpha', \theta')$ in the sense of Definition 4.2.2 (i) and (ii) (without assuming condition (iii)), there is always a (possibly different) connection $\tilde{\theta}$ to be found on (Γ, α) so that $\pi : (\Gamma, \alpha, \tilde{\theta}) \rightarrow (\Gamma', \alpha', \theta')$ is a fibration of 1-skeleta with connections in the sense of Definition 4.2.2 (i), (ii), and (iii).

What we call a fibration of 1-skeleta with connections is called a GKM-fibration and what we call a fiber bundle of 1-skeleta with connections, is called a GKM-fiber bundle in [28].

Figure 34 shows a typical fiber bundle of 1-skeleta; the linear part of the transition map across a horizontal edge in this case is reflection about the line perpendicular to that

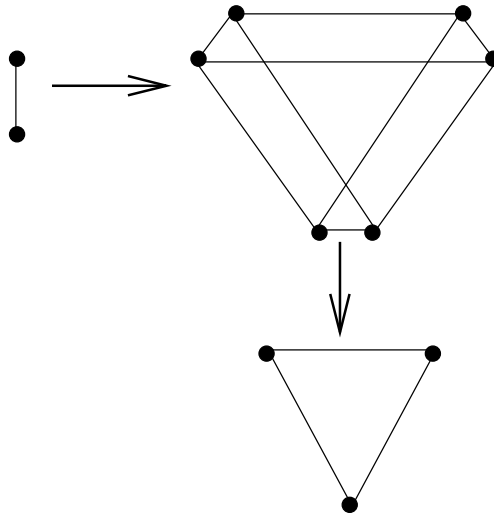

Figure 34. a fiber bundle

edge.

It will be useful for us to relax condition (ii) in Definition 4.2.4 (for instance when we discuss the blow-up in the next section). Therefore we introduce the notion of a *pseudo-fiber bundle*.

Definition 4.2.5. A morphism $\pi: (\Gamma, \alpha, \theta) \rightarrow (\Gamma', \alpha', \theta')$ is a pseudo-fiber bundle if

i. π is a fibration

ii. for every edge $e' := \overline{p'q'} \in E_{\Gamma'}$ there are isomorphisms of graph-connection pairs

$$(\Psi_{e'})_G: (\Gamma^{p'}, \theta^{p'}) \rightarrow (\Gamma^{q'}, \theta^{q'})$$

such that for each vertex $p \in \pi_G^{-1}(p') \cap V_{\Gamma}$, if $q = (\Psi_{e'})_G(p) \in \pi_G^{-1}(q')$ then $\overline{pq} \in (E_{\Gamma}^h)_p$.

Thus the fibers of a pseudo-fiber bundle are still isomorphic as graph-connection pairs, as with fiber bundles, but in a pseudo-fiber bundle, adjacent fibers need not be *linearly*

related. We will use the same notation to denote a pseudo-fiber bundle:

$$\begin{array}{ccc} \pi^{-1}(p') & \xrightarrow{i_{p'}} & (\Gamma, \alpha, \theta) \\ & & \downarrow \pi \\ & & (\Gamma', \alpha', \theta'). \end{array}$$

Shown in Figure 35 is an example of a pseudo-fiber bundle (over a single edge, with fibers complete 1-skeleta on 4-vertices) that fails to be a fiber bundle in the sense of Definition 4.2.4. This pseudo-fiber bundle actually arises as a GKM T -manifold: the total space is a 3 dimensional toric variety, X , over \mathbb{C} with a dense open torus $\hat{T} = (\mathbb{C}^*)^3$, and $T \subset \hat{T}$ is a codimension one sub-torus acting on X by restriction.

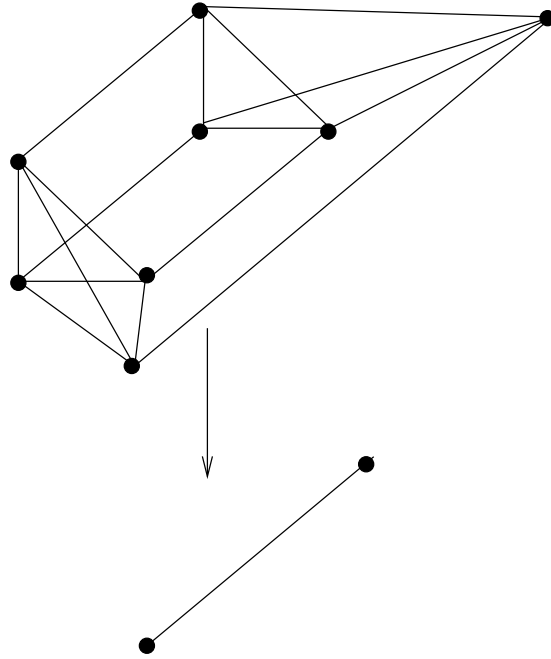

Figure 35. a pseudo-fiber bundle

Note that the fibration of 1-skeleta (with connections) shown in Figure 33 is not even a pseudo-fiber bundle, let alone a fiber bundle of 1-skeleta (with connections).

Special Cases

We take this opportunity to point out some relevant special cases of fiber bundles and pseudo-fiber bundles.

Direct Product

Let $(\Gamma', \alpha', \theta'), (\Gamma_0, \alpha_0, \theta_0) \subset \mathbb{R}^n$ be two 1-skeleta with connections in \mathbb{R}^n . We construct the *direct product* 1-skeleton $(\Gamma, \alpha, \theta) \subset \mathbb{R}^n$ as follows: Set $\Gamma = (V_\Gamma, E_\Gamma)$ where

$$V_\Gamma = V_{\Gamma_0} \times V_{\Gamma'}$$

and

$$E_\Gamma = E_{\Gamma_0} \times V_{\Gamma'} \sqcup V_{\Gamma_0} \times E_{\Gamma'};$$

we shall set

$$E_\Gamma^h = V_{\Gamma_0} \times E_{\Gamma'}$$

and

$$E_\Gamma^v = E_{\Gamma_0} \times V_{\Gamma'}.$$

We have natural projection morphisms of graphs

$$(\pi')_G: \Gamma \rightarrow \Gamma'$$

and

$$(\pi_0)_G: \Gamma \rightarrow \Gamma_0.$$

Define the function

$$\alpha: E_\Gamma \rightarrow \mathbb{R}^n$$

by

$$\alpha(e) = \begin{cases} \alpha'((\pi')_G(e)) & \text{if } e \in E_\Gamma^h \\ \alpha_0((\pi_0)_G(e)) & \text{if } e \in E_\Gamma^v. \end{cases}$$

Define θ to be the unique connection on Γ whose restriction to

$$\{v_0\} \times \Gamma'$$

is θ' for each $v_0 \in V_{\Gamma_0}$ and on

$$\Gamma_0 \times \{v'\}$$

is θ_0 for each $v' \in V_{\Gamma'}$. This defines a 1-skeleton $(\Gamma, \alpha, \theta) \subset \mathbb{R}^n$ called the *direct product* 1-skeleton with *factors* $(\Gamma_0, \alpha_0, \theta_0)$ and $(\Gamma', \alpha', \theta')$. As indicated above we will regard $(\Gamma', \alpha', \theta')$ as the “horizontal” factor and $(\Gamma_0, \alpha_0, \theta_0)$ as the “vertical” factor. Then as one might expect, the projection morphism

$$\pi' = ((\pi')_G, I_{\mathbb{R}^n}): (\Gamma, \alpha, \theta) \rightarrow (\Gamma', \alpha', \theta')$$

is a fiber bundle of 1-skeleta; the map $\pi'_G: (E_{\Gamma'}^h)_p \rightarrow (E_{\Gamma_0})_{\pi'_G(p)}$ is a bijection for each vertex $p \in V_{\Gamma'}$ and fibers are just $(\pi'_G)^{-1}(p') = \Gamma_0 \times \{p'\}$. The transition morphisms

$$\Psi_{e'} = ((\Psi_{e'})_G, (\Psi_{e'})_L): \pi^{-1}(p') \rightarrow \pi^{-1}(q')$$

are trivial with

$$(\Psi_{e'})_G: \Gamma_0 \times \{p'\} \rightarrow \Gamma_0 \times \{q'\}$$

defined by

$$(\Psi_{e'})_G(x, p') = (x, q')$$

and

$$(\Psi_{e'})_L = I_{\mathbb{R}^n}: \mathbb{R}^n \rightarrow \mathbb{R}^n.$$

Remark. Note that we could have set $(\Gamma_0, \alpha_0, \theta_0)$ to be the “horizontal” factor and $(\Gamma', \alpha', \theta')$ the “vertical” factor. In that case the projection morphism

$$(\pi_0) = ((\pi_0)_G, I_{\mathbb{R}^n}): (\Gamma, \alpha, \theta) \rightarrow (\Gamma_0, \alpha_0, \theta_0)$$

is also a fiber bundle of 1-skeleta with connections with general fiber $(\Gamma', \alpha', \theta')$.

Blow-Up

Let $(\Gamma, \alpha, \theta) \subset \mathbb{R}^n$ be a 1-skeleton and let $(\Gamma_0, \alpha_0, \theta_0) \subset (\Gamma, \alpha, \theta)$ be a level sub-skeleton. We have seen in chapter 2 that we can construct a new 1-skeleton $(\Gamma^\sharp, \alpha^\sharp, \theta^\sharp) \subset \mathbb{R}^n$ called the *blow-up* of (Γ, α, θ) along $(\Gamma_0, \alpha_0, \theta_0)$. The blow-up comes equipped with a morphism of 1-skeleta with connections

$$\beta = (\beta_G, I_{\mathbb{R}^n}): (\Gamma^\sharp, \alpha^\sharp, \theta^\sharp) \rightarrow (\Gamma, \alpha, \theta)$$

called the *blow-down* morphism. Let

$$\beta^{-1}(\Gamma_0, \alpha_0, \theta_0) \subset (\Gamma^\sharp, \alpha^\sharp, \theta^\sharp)$$

denote the *singular locus* of the blow-up; by Theorem 4.2.3 it is a totally geodesic sub-skeleton that we denote by

$$(\Gamma_0^\sharp, \alpha_0^\sharp, \theta_0^\sharp).$$

Then the restriction of the blow-down to the singular locus is a *pseudo-fiber bundle* over the sub-skeleton $(\Gamma_0, \alpha_0, \theta_0)$. That is, the morphism

$$\beta_0: (\Gamma_0^\sharp, \alpha_0^\sharp, \theta_0^\sharp) \rightarrow (\Gamma_0, \alpha_0, \theta_0)$$

is a fibration of 1-skeleta with connections whose fibers are *complete* 1-skeleta (1-skeleta whose underlying graph is a complete graph), and the transition maps for $e_0 := \overline{p_0 q_0} \in E_{\Gamma_0}$,

$$(\Psi_{e_0})_G: (\Gamma^{p_0}, \theta^{p_0}) \rightarrow (\Gamma^{q_0}, \theta^{q_0})$$

arise naturally from the normal connection maps

$$\theta_{e_0}^\perp: N_{p_0}^0 \rightarrow N_{q_0}^0.$$

While the blow-down morphism may be a fiber bundle of 1-skeleta in some cases, it will only be a pseudo-fiber bundle in general. For a more detailed description of this

construction, the reader is directed to the discussion in chapter 2. We will have more to say about the cohomology rings of the blow-up in the next section.

4.2.1 Leray-Hirsch Theorem

A (pseudo-) fiber bundle of 1-skeleta with connections gives a precise way to “decompose” certain 1-skeleta with connections into smaller “pieces” called the base and the fiber (although technically the base does not constitute a sub-skeleta). As one might hope, under certain additional hypotheses, this geometric decomposition leads to an algebraic decomposition of the ordinary cohomology ring of the total space in terms of the cohomology rings of the base and the fiber. There is an analogue of the Leray-Hirsch decomposition on (topological) cohomology rings for fiber bundles (of topological spaces) in the 1-skeleton setting, due to Guillemin, Sabatini and Zara.

While we are interested in studying the ordinary cohomology rings, the equivariant cohomology has a much more concrete, geometric description that is easier to use in general. The strategy to prove this Leray-Hirsch decomposition for the ordinary cohomology is to first derive an “equivariant version” of the decomposition for the equivariant cohomology rings of a fiber bundle. Then once the result is established for equivariant cohomology, the result for ordinary cohomology will follow from purely formal considerations.

Given 1-skeleta $(\Gamma, \alpha) \subset \mathbb{R}^n$ and $(\Gamma', \alpha') \subset \mathbb{R}^m$ and a morphism $\pi: (\Gamma, \alpha) \rightarrow (\Gamma', \alpha')$, the induced map $\pi^*: H(\Gamma', \alpha') \rightarrow H(\Gamma, \alpha)$ endows $H(\Gamma, \alpha)$ with the structure of a module over $H(\Gamma', \alpha')$. If π is a (pseudo-) fiber bundle this module structure is very well behaved under certain additional hypotheses. The following result of Guillemin, Sabatini and Zara is an analogue of the Leray-Hirsch theorem for fiber bundles in algebraic topology. We refer the reader to [28] for the proof.

Theorem 4.2.6. ([28]) *Let*

$$\begin{array}{ccc} \pi^{-1}(p') & \xrightarrow{i_{p'}} & (\Gamma, \alpha, \theta) \\ & & \downarrow \pi \\ & & (\Gamma', \alpha', \theta') \end{array}$$

be a (pseudo-) fiber bundle of 1-skeleta with connections. Assume that

1. $H(\pi^{-1}(p'))$ *is a free S -module for all $p' \in V_{\Gamma'}$ and*
2. *there exist classes $c_1, \dots, c_N \in H(\Gamma, \alpha)$ such that the restrictions $i_{p'}^*(c_1), \dots, i_{p'}^*(c_N) \in H(\pi^{-1}(p'))$ are an S -basis for all $p' \in V_{\Gamma'}$.*

Then the classes c_1, \dots, c_N are a free $H(\Gamma', \alpha')$ -module basis for $H(\Gamma, \alpha)$.

Equivalently for any $p' \in V_{\Gamma'}$ the map

$$H(\pi^{-1}(p')) \otimes_S H(\Gamma', \alpha') \xrightarrow{\Phi} H(\Gamma, \alpha)$$

$$i_{p'}^*(c_i) \otimes f \longrightarrow c_i \cdot \pi^*(f).$$

is an isomorphism of $H(\Gamma', \alpha')$ -modules (where the module structure on the tensor product is multiplication in the first factor).

Proof. See [28], Theorem 3.6. □

Although we do not need it in the sequel, the following seems to be a useful fact in the theory of (GKM) fiber bundles.

In the case where

$$\begin{array}{ccc} \pi^{-1}(p') & \xrightarrow{i_{p'}} & (\Gamma, \alpha, \theta) \\ & & \downarrow \pi \\ & & (\Gamma', \alpha', \theta') \end{array}$$

is a GKM-fiber bundle of 1-skeleta with connections (i.e. a fiber bundle whose base, fiber and total space are all GKM 1-skeleta), the following lemma tells us that to check

if classes $c_1, \dots, c_N \in H(\Gamma, \alpha)$ actually restrict to an S -basis on *every* fiber, it is enough to check that they do so on a single fiber.

Lemma 4.2.7. *Let*

$$\begin{array}{ccc} \pi^{-1}(p') & \xrightarrow{i_{p'}} & (\Gamma, \alpha, \theta) \\ & & \downarrow \pi \\ & & (\Gamma', \alpha', \theta') \end{array}$$

be a GKM-fiber bundle (i.e. a fiber bundle of GKM 1-skeleta with connections). Assume that $H(\pi^{-1}(p'))$ is a free S -module. Suppose that $c_1, \dots, c_N \in H(\Gamma, \alpha)$ are classes such that

$$i_{p'}^*(c_1), \dots, i_{p'}^*(c_N) \in H(\Gamma_0, \alpha_0)$$

are an S -basis for some $p' \in V_{\Gamma'}$. Then

$$i_{q'}^*(c_1), \dots, i_{q'}^*(c_N) \in H(\Gamma_0, \alpha_0)$$

are an S -basis for all $q' \in V_{\Gamma'}$.

Before we prove Lemma 4.2.7 we need a sub-lemma describing the linear part of the transition morphisms. This is due to Guillemin, Sabatini, and Zara.

Sub-Lemma 1. *Given a GKM-fiber bundle*

$$\begin{array}{ccc} \pi^{-1}(p') & \xrightarrow{i_{p'}} & (\Gamma, \alpha, \theta) \\ & & \downarrow \pi \\ & & (\Gamma', \alpha', \theta'), \end{array}$$

an oriented edge $e' := \overline{p'q'} \in E_{\Gamma'}$ we can choose a transition morphism $\Psi_{e'} : \pi^{-1}(p') \rightarrow \pi^{-1}(q')$, such that

$$(\Psi_{e'})_L(x) = x + c(x)\alpha'(e')$$

for all $x \in \mathbb{R}^n$ and some linear functional $c : \mathbb{R}^n \rightarrow \mathbb{R}$.

Proof. See [28] Proposition 2.11. □

Now we are ready to prove Lemma 4.2.7.

Proof of Lemma 4.2.7. Let $c_1, \dots, c_N \in H(\Gamma, \alpha)$ be classes such that

$$i_{p'}^*(c_1), \dots, i_{p'}^*(c_N) \in H(\Gamma_0, \alpha_0)$$

are a basis. To prove Lemma 4.2.7, it suffices to show that

$$i_{q'}^*(c_1), \dots, i_{q'}^*(c_N) \in H(\Gamma_0, \alpha_0)$$

is a basis for $e' := \overline{p'q'} \in E_{\Gamma'}$. Let $\Psi_{e'}$ denote the transition morphism.

We have the following (non-commutative in general) diagram:

$$\begin{array}{ccc} \pi^{-1}(p') & \xrightarrow{i_{p'}} & (\Gamma, \alpha, \theta) \\ \Psi_{e'} \uparrow & & \nearrow i_{q'} \\ \pi^{-1}(q') & & \end{array}$$

Since the classes

$$\{i_{p'}^*(c_i)\}_{i=1}^N \subset H(\pi^{-1}(p'))$$

are an S -module basis for $H(\pi^{-1}(p'))$, the classes

$$\{\Psi_{e'}^* \circ i_{p'}^*(c_i)\}_{i=1}^N \subset H(\pi^{-1}(q'))$$

are an S -basis for $H(\pi^{-1}(q'))$, since $\Psi_{e'}$ is an isomorphism.

We want to show that the classes

$$\{i_{q'}^*(c_i)\}_{i=1}^N \subset H(\pi^{-1}(q'))$$

are also an S -basis for $H(\pi^{-1}(q'))$.

The idea is to compare the classes $\Psi_{e'}^* \circ i_{p'}^*(c_i)$ and $i_{q'}^*(c_i)$ on the fiber $\pi^{-1}(q')$ by constructing equivariant classes on the fiber over e' . Here are the details.

Let $\pi^{-1}(e') \subset (\Gamma, \alpha, \theta)$ denote the fiber over $e' \in E_{\Gamma}$, and let $(\pi_G)^{-1}(e') = (V^{e'}, E^{e'})$.

Define the function

$$F_i: V^{e'} \rightarrow S$$

by the formula

$$F_i(v) = \begin{cases} i_{p'}^*(c_i)(v) & \text{if } \pi_G(v) = p' \\ i_{q'}^*(c_i)(v) & \text{if } \pi_G(v) = q'. \end{cases}$$

Then F_i is just the restriction of the equivariant class $c_i \in H(\Gamma, \alpha)$ to the sub-skeleton $\pi^{-1}(e')$; hence $F \in H(\pi^{-1}(e'))$.

Define another function

$$G_i: V^{e'} \rightarrow S$$

by the formula

$$G_i(v) = \begin{cases} i_{p'}^*(c_i)(v) & \text{if } \pi_G(v) = p' \\ \Psi_{e'}^* \circ i_{p'}^*(c_i)(v) & \text{if } \pi_G(v) = q'. \end{cases}$$

G is also an equivariant class in $H(\pi^{-1}(e'))$ by sub-Lemma 1. Therefore the equivariant class $F - G \in H(\pi^{-1}(e'))$ is supported on the fiber

$$\pi^{-1}(q') \xrightarrow{\subset} \pi^{-1}(e').$$

Hence the class $F - G$ satisfies

$$(F - G)(x) \equiv 0 \pmod{\alpha'(e')}$$

for all vertices x of $\pi^{-1}(q')$. Also for any vertical edge e of $\pi^{-1}(q')$, the axioms for an axial function demand that $\alpha(e')$ and $\alpha(e)$ are linearly independent. This means that we can “divide” $(F - G)$ by the constant $\alpha(e') \cdot \mathbf{1}$ on $\pi^{-1}(q')$. Therefore $(F - G)$ restricted

to $H(\pi^{-1}(q'))$ is in $S^+ \cdot H(\pi^{-1}(q'))$; this shows that the equivariant classes $\Psi_\gamma \circ i_{p'}^*(c_i)$ and $i_{q'}^*(c_i)$ represent the same ordinary class. Therefore since $\{\Psi_\gamma \circ i_{p'}^*(c_i)\}_i$ are an S -basis, the classes $\{i_{q'}^*(c_i)\}_i$ must also be an S -basis. \square

We now return to the general case of a pseudo-fiber bundle. Another way to phrase Theorem 4.2.6 is as follows: if $H(\pi^{-1}(p'))$ is free and if the restriction homomorphism

$$i_{p'} : H(\Gamma, \alpha) \rightarrow H(\pi^{-1}(p'))$$

is *surjective* for every $p' \in V_{\Gamma'}$, then for any S -module section

$$s : H(\pi^{-1}(p')) \rightarrow H(\Gamma, \alpha, \theta)$$

of $i_{p'}^*$ for any fixed $p' \in V_{\Gamma'}$, the map

$$H(\pi^{-1}(p')) \otimes_S H(\Gamma', \alpha') \xrightarrow{\Phi} H(\Gamma, \alpha)$$

$$g \otimes f \longrightarrow s(g) \cdot \pi^*(f)$$

is an isomorphism of $H(\Gamma', \alpha')$ -modules (note that the condition that $i_{p'} : H(\Gamma, \alpha) \rightarrow H(\pi^{-1}(p'))$ is surjective is equivalent to the existence of classes $c_1, \dots, c_N \in H(\Gamma, \alpha)$ that restrict to a basis on every fiber since the condition that any classes in $H(\Gamma, \alpha)$ restrict to a basis on a single fiber $\pi^{-1}(p')$ cuts out a Zariski open set in $H(\Gamma, \alpha)$ which is non-empty if $i_{p'}^*$ is surjective). An important point here is that the map Φ is *not* a ring homomorphism in general. If the restriction map

$$i_{p'}^* : H(\Gamma, \alpha) \rightarrow H(\pi^{-1}(p'))$$

actually admits an S -algebra section

$$s : H(\pi^{-1}(p')) \rightarrow H(\Gamma, \alpha),$$

then the map Φ is an isomorphism of S -algebras (where the S -algebra structure on the tensor product is the standard one assigned to the tensor product over S of two S -algebras). Hence as a corollary of Theorem 4.2.6 we get a Künneth formula for the equivariant cohomology ring of the direct product 1-skeleton.

Corollary 4.2.8. *Let $(\Gamma, \alpha, \theta) \subset \mathbb{R}^n$ be the direct product 1-skeleton with “horizontal” factor $(\Gamma', \alpha') \subset \mathbb{R}^n$ and “vertical” factor $(\Gamma_0, \alpha_0) \subset \mathbb{R}^n$. Assume that $H(\Gamma_0, \alpha_0)$ is a free S -module.*

$$H(\Gamma_0, \alpha_0) \otimes_S H(\Gamma', \alpha') \xrightarrow{\Phi} H(\Gamma, \alpha)$$

$$g \otimes f \xrightarrow{\quad} (\pi_0)^*(g) \cdot (\pi')^*(f)$$

is an isomorphism of S -algebras.

Proof. The point here is that the restriction homomorphisms are always surjective;

$$i_{p'}^* : H(\Gamma, \alpha, \theta) \rightarrow H(\Gamma_0, \alpha_0, \theta_0)$$

has as a section the induced map of the other projection

$$(\pi_0)^* : H(\Gamma_0, \alpha_0, \theta_0) \rightarrow H(\Gamma, \alpha, \theta).$$

By Theorem 4.2.6 Φ is an isomorphism of $H(\Gamma', \alpha')$ -modules; since $(\pi_0)^*$ is a ring homomorphism, Φ is a *ring* isomorphism. \square

We will see in the next section that Theorem 4.2.6 also implies a decomposition theorem for the equivariant cohomology of the blow-up of a 1-skeleton.

We will now deduce an analogous decomposition for the *ordinary* cohomology of the total space of a fiber bundle. We will see that this is really just a formal consequence of Theorem 4.2.6.

Theorem 4.2.9. *Given a pseudo-fiber bundle*

$$\begin{array}{ccc} \pi^{-1}(p') & \xrightarrow{i_{p'}} & (\Gamma, \alpha, \theta) \\ & & \downarrow \pi \\ & & (\Gamma', \alpha', \theta') \end{array}$$

satisfying the hypotheses of Theorem 4.2.6, the map

$$\begin{array}{ccc} \overline{H(\pi^{-1}(p'))} \otimes_{\mathbb{R}} \overline{H(\Gamma', \alpha')} & \xrightarrow{\phi} & \overline{H(\Gamma, \alpha)} \\ \overline{i_{p'}^*(\overline{c_i})} \otimes \overline{f} & \longrightarrow & \overline{c_i} \cdot \overline{\pi^*(f)}. \end{array}$$

is an isomorphism of $\overline{H(\Gamma', \alpha')}$ -modules.

Proof. The map

$$H(\pi^{-1}(p')) \otimes_S H(\Gamma', \alpha') \xrightarrow{\Phi} H(\Gamma, \alpha) \quad (4.2.7)$$

$$i_{p'}^*(c_i) \otimes f \longrightarrow c_i \cdot \pi^*(f).$$

is in particular an isomorphism of S -modules (where the tensor product is equipped with the usual S -module structure assigned to the tensor product of two S -modules over S). Therefore we can just apply the functor $- \otimes_S S/S^+$ both sides of (4.2.7) and use the identification

$$(H(\Gamma', \alpha') \otimes_S H(\pi^{-1}(p'))) \otimes_S S/S^+ \cong (H(\Gamma', \alpha') \otimes_S S/S^+) \otimes_{S/S^+} (H(\pi^{-1}(p')) \otimes_S S/S^+).$$

This completes the proof of Theorem 4.2.9. □

Thus we also get a Künneth formula for the ordinary cohomology ring for the direct product 1-skeleton by the same arguments.

Corollary 4.2.10. Let $(\Gamma, \alpha, \theta) \subset \mathbb{R}^n$ be the direct product 1-skeleton with factors $(\Gamma', \alpha', \theta') \subset \mathbb{R}^n$ and $(\Gamma_0, \alpha_0, \theta_0) \subset \mathbb{R}^n$ with projection maps

$$\begin{array}{ccc} & \overline{H(\Gamma, \alpha)} & \\ \xleftarrow{(\pi_0)^*} & & \xrightarrow{(\pi')^*} \\ \overline{H(\Gamma_0, \alpha_0)} & & \overline{H(\Gamma', \alpha')} \end{array}$$

Then the map

$$\begin{array}{ccc} \overline{H(\Gamma', \alpha')} \otimes_{\mathbb{R}} \overline{H(\Gamma_0, \alpha_0)} & \xrightarrow{\Phi} & \overline{H(\Gamma, \alpha)} \\ x \otimes y & \longrightarrow & \overline{(\pi')^*(x)} \cdot \overline{(\pi_0)^*(y)}. \end{array}$$

is an \mathbb{R} -algebra isomorphism.

Proof. Same as in Theorem 4.2.9. □

4.2.2 Lefschetz Package for Fiber Bundles

We now come to one of the main results of this chapter. We introduce the notion of a *Lefschetz algebra* in order to distill the algebraic methods from the proofs of the main results about 1-skeleta. First we prove that the tensor product of two Lefschetz algebras is a Lefschetz algebra. We then extend this result to a certain class of rings that are *vector space-isomorphic* (not *ring-isomorphic*) to tensor products of Lefschetz algebras. Then using the results of Corollary 4.2.10 and Corollary 4.2.9 we are able to deduce that if the factors of a direct product 1-skeleton have the Lefschetz package, then so does the direct product, and more generally if the base and the fiber of a fiber bundle of 1-skeleta have the Lefschetz package, then so does the total space. Throughout this section all homomorphisms are graded of degree zero unless otherwise indicated. We use the notation $R[i]$ to denote the graded object R shifted down by i (i.e. $(R[i])^j = R^{j+i}$).

Definition 4.2.11. A Lefschetz algebra is a pair (R, l) consisting of an \mathbb{N} -graded Artinian \mathbb{R} -algebra R together with a fixed Lefschetz element $l \in R^1$ for R .

It will be convenient to think of the \mathbb{R} -algebra R as a module over the polynomial ring in one variable $\mathbb{R}[X]$ (with the usual grading), where X acts on R by multiplication by l . In fact any degree one endomorphism $A: R \rightarrow R[1]$ defines a graded $\mathbb{R}[X]$ -module structure on R by defining

$$X^i \cdot r := A^i(r).$$

Definition 4.2.12. A Lefschetz module is a finite dimensional \mathbb{N} -graded $\mathbb{R}[X]$ -module $M = \bigoplus_{i=0}^d M^i$ such that the multiplication maps $X^{d-2i} \cdot m$ are isomorphisms for $0 \leq i \leq \lfloor \frac{d}{2} \rfloor$.

Thus a Lefschetz algebra (R, l) is a Lefschetz module R with a graded \mathbb{R} -algebra structure whose X action is given by multiplication by the element $l \in R^1$.

The simplest non-trivial example of a Lefschetz algebra is the polynomial ring in one variable divided by a monomial:

$$\frac{\mathbb{R}[X]}{\langle X^{n+1} \rangle}.$$

Here the fixed Lefschetz element is the equivalence class of $X \in \mathbb{R}[X]$. These “simple” Lefschetz algebras turn out to be the basic building blocks of all Lefschetz modules.

Definition 4.2.13. A simple Lefschetz algebra is $(P(n), X)$ where

$$P(n) := \frac{\mathbb{R}[X]}{\langle X^{n+1} \rangle}.$$

Given a Lefschetz algebra (R, l) , where $R = \bigoplus_{i=0}^r R^i$, define the homogeneous subspace $P \subset R$ where

$$P^i := \ker \{l^{r-2i+1} : R^i \rightarrow R^{r-i+1}\}.$$

Note that for $i > \frac{r}{2}$, $P^i = 0$. The subspace P is called the *primitive* subspace of (R, l) . We have the following direct-sum decomposition of R .

Proposition 4.2.14. (*Primitive Decomposition*) *There is an isomorphism of vector spaces*

$$R = \bigoplus_{i=0}^{\lfloor \frac{r}{2} \rfloor} \left(\bigoplus_{j=0}^{r-2i} l^j \cdot P^i \right).$$

Equivalently R is isomorphic (as Lefschetz modules) to a direct sum of shifted copies of $P(r-2i)$ for $0 \leq i \leq \lfloor \frac{r}{2} \rfloor$:

$$R \cong \bigoplus_{i=0}^{\lfloor \frac{r}{2} \rfloor} p_i \cdot P(r-2i)[i],$$

where $p_i = \dim_{\mathbb{R}}(P^i)$.

Proof. To prove Proposition 4.2.14 we will show that

$$R^i = P^i \oplus l(P^{i-1}) \oplus \dots \oplus l^i(P^0)$$

for $0 \leq i \leq r$. First we check that

$$R^i = P^i \oplus l(R^{i-1}).$$

Let $\alpha \in R^i$. If $\alpha \in P^i \cap l(R^{i-1})$ then $\alpha = l(\beta)$ and

$$l^{r-2i+1} \cdot \alpha = 0 = l^{r-2(i-1)}\beta$$

and since

$$l^{r-2(i-1)}: R^{i-1} \rightarrow R^{r-(i-1)}$$

is an isomorphism, we conclude that β and therefore α must be zero. Now fix $\alpha \in R^i$ and consider the element

$$l^{r-2i+1} \cdot \alpha \in R^{r-i+1} = R^{r-(i-1)}.$$

Since $l^{r-2(i-1)}: R^{i-1} \rightarrow R^{r-(i-1)}$ is an isomorphism, there is a $\beta \in R^{i-1}$ such that

$$l^{r-2(i-1)} \cdot \beta = l^{r-2i+1} \cdot \alpha.$$

Hence

$$0 = l^{r-2i+1} \cdot (\alpha - l \cdot \beta)$$

and thus $\alpha - l \cdot \beta \in P^i$. Therefore we can write $\alpha = (\alpha - l \cdot \beta) + l \cdot \beta$. This shows that $R^i = P^i \oplus l(R^{i-1})$.

To prove the proposition we use induction on i : The base case is trivial since $R^0 = P^0$. Assuming that $R^{i-1} = P^{i-1} \oplus l(P^{i-2}) \oplus \dots \oplus l^{i-1}(P^0)$ the result follows from the equation $R^i = P^i \oplus l(R^{i-1})$. By choosing a basis for the subspaces P^i we obtain the equivalent decomposition

$$R \cong \bigoplus_{i=0}^{\lfloor \frac{r}{2} \rfloor} p_i \cdot P(r-2i)[i].$$

This completes the proof of Proposition 4.2.14. \square

The following lemma is due to Barthel, Brasselet, Fieseler and Kaup in [2].

Lemma 4.2.15. *Let (U, μ) and (V, ν) be two Lefschetz algebras. Define the \mathbb{N} -graded Artinian \mathbb{R} -algebra*

$$W := U \otimes_{\mathbb{R}} V.$$

Let $\omega := \mu \otimes 1 + 1 \otimes \nu \in W^1$. Then (W, ω) is a Lefschetz algebra.

Proof. See [2], Proposition 5.7. \square

We are now in a position to state and prove the main algebraic result of this section. The proof relies on Lemma 4.2.15.

Theorem 4.2.16. *Let (B, λ) and (F, τ) be Lefschetz algebras. Let $W = \bigoplus_{i \geq 0} W^i$ be an \mathbb{N} -graded Artinian \mathbb{R} -algebra equipped with \mathbb{R} -algebra homomorphisms*

$$\pi: B \rightarrow W$$

and

$$\iota: W \rightarrow F.$$

Suppose that

- i. W is a free B -module via π
- ii. ι is surjective with $\ker\{\iota\} = B^+ \cdot W$.

Let $x \in W^1$ be any homogeneous element such that $\iota(x) = \tau$. Then for some $t \in \mathbb{R} \setminus \{0\}$, the pair $(W, \pi(\lambda) + tx)$ is a Lefschetz algebra.

Before launching into the proof, let us give some consequences of Theorem 4.2.16 in terms of 1-skeleta.

Theorem 4.2.17. *Let*

$$\begin{array}{ccc} \pi^{-1}(p') & \xrightarrow{i_{p'}} & (\Gamma, \alpha) \\ & & \downarrow \pi \\ & & (\Gamma', \alpha') \end{array}$$

be a pseudo-fiber bundle of 1-skeleta satisfying the hypotheses of Theorem 4.2.6. If (Γ', α') and $\pi^{-1}(p')$ have the Lefschetz package then (Γ, α) also has the Lefschetz package.

Proof. Part of the hypotheses of Theorem 4.2.6 is that the restriction map

$$i_{p'}^* : H(\Gamma, \alpha) \rightarrow H(\pi^{-1}(p'))$$

is surjective for every $p' \in V_{\Gamma'}$. Since the functor $- \otimes_S \mathbb{R}$ is right exact, the residual map

$$\overline{i_{p'}^*} : \overline{H(\Gamma, \alpha)} \rightarrow \overline{H(\pi^{-1}(p'))}$$

is also surjective for any $p' \in V_{\Gamma'}$. Fix any “base point” $p' \in V_{\Gamma'}$ and set

$$\iota := \overline{i_{p'}^*} : \overline{H(\Gamma, \alpha)} \rightarrow \overline{H(\pi^{-1}(p'))}.$$

By Corollary 4.2.9 we conclude that $\overline{H(\Gamma, \alpha)}$ is a free $\overline{H(\Gamma', \alpha')}$ -module via the induced map

$$\pi := \overline{\pi^*} : \overline{H(\Gamma', \alpha')} \rightarrow \overline{H(\Gamma, \alpha)}.$$

Finally note that

$$\ker\{\iota\} = \overline{(H(\Gamma', \alpha'))^+ H(\Gamma, \alpha)} :$$

Since

$$\iota_{p'}^* \circ \pi^* : H(\Gamma', \alpha') \rightarrow H(\pi^{-1}(p'))$$

has image the constant functions, we certainly have \supseteq . Since $\overline{H(\Gamma, \alpha)}$ is a free module over $\overline{H(\Gamma', \alpha')}$ on a basis that is an \mathbb{R} -basis for $\overline{H(\pi^{-1}(p'))}$ the containment \subseteq follows from dimension considerations; that is

$$\begin{aligned} \dim_{\mathbb{R}}(\overline{(H(\Gamma', \alpha'))^+ H(\Gamma, \alpha)}) &= \dim_{\mathbb{R}}(\overline{(H(\Gamma', \alpha'))^+}) \cdot \dim_{\mathbb{R}}(\overline{H(\Gamma_0, \alpha_0)}) \\ &= (\dim_{\mathbb{R}}(\overline{H(\Gamma', \alpha')}) - 1) \cdot \dim_{\mathbb{R}}(\overline{H(\Gamma_0, \alpha_0)}) \end{aligned}$$

and

$$\begin{aligned} \dim_{\mathbb{R}}(\ker\{\iota\}) &= \dim_{\mathbb{R}}(\overline{H(\Gamma, \alpha)}) - \dim_{\mathbb{R}}(\overline{H(\Gamma_0, \alpha_0)}) \\ &= \dim_{\mathbb{R}}(\overline{H(\Gamma', \alpha')}) \cdot \dim_{\mathbb{R}}(\overline{H(\Gamma_0, \alpha_0)}) - \dim_{\mathbb{R}}(\overline{H(\Gamma_0, \alpha_0)}) \\ &= (\dim_{\mathbb{R}}(\overline{H(\Gamma', \alpha')}) - 1) \cdot \dim_{\mathbb{R}}(\overline{H(\Gamma_0, \alpha_0)}). \end{aligned}$$

Therefore we can apply Theorem 4.2.16 where $B = \overline{H(\Gamma', \alpha')}$, $F = \overline{H(\pi^{-1}(p'))}$ and $W = \overline{H(\Gamma, \alpha)}$. Since (Γ', α') and $\pi^{-1}(p')$ have the Lefschetz package, Theorem 4.2.16 implies that (Γ, α) also has the Lefschetz package. This completes the proof of Theorem 4.2.17. \square

Corollary 4.2.18. *Let (Γ, α) denote the direct product 1-skeleton with factors (Γ', α') and (Γ_0, α_0) . Suppose that $H(\Gamma_0, \alpha_0)$ is a free S -module. If (Γ', α') and (Γ_0, α_0) have the Lefschetz package then (Γ, α) also has the Lefschetz package.*

Proof. Let

$$\pi' : (\Gamma', \alpha') \rightarrow (\Gamma, \alpha)$$

and

$$\pi_0 : (\Gamma_0, \alpha_0) \rightarrow (\Gamma, \alpha)$$

denote the natural projection morphisms. By Corollary 4.2.10 the map

$$\overline{H(\Gamma', \alpha')} \otimes_{\mathbb{R}} \overline{H(\Gamma_0, \alpha_0)} \xrightarrow{\Phi} \overline{H(\Gamma, \alpha)}$$

$$x \otimes y \longrightarrow (\pi')^*(x) \cdot (\pi_0)^*(y)$$

is an isomorphism of \mathbb{R} -algebras. By assumption there exist elements $l' \in \overline{H^1(\Gamma', \alpha')}$ and $l_0 \in \overline{H^1(\Gamma_0, \alpha_0)}$ such that the pairs

$$(\overline{H(\Gamma', \alpha')}, l')$$

and

$$(\overline{H(\Gamma_0, \alpha_0)}, l_0)$$

are Lefschetz algebras. Then by Lemma 4.2.15 the pair

$$(\overline{H(\Gamma, \alpha)}, (\pi')(l') + (\pi_0)(l_0))$$

is also a Lefschetz algebra. This completes the proof of Theorem 4.2.18. \square

Corollary 4.2.18 could also have been deduced immediately from Lemma 4.2.15.

Proof of Theorem 4.2.16

The remainder of this section will be devoted to the proof of Theorem 4.2.16.

With notations as in the statement of Theorem 4.2.16, let $B = \bigoplus_{i=0}^b B^i$ and $F = \bigoplus_{i=0}^f F^i$. Consider W as a B module via π and let $\text{End}_B^1(W)$ denote the graded B -module

endomorphisms of degree 1. Any choice of $A \in \text{End}_B^1(W)$ endows W with a $B[X]$ -module structure by the prescription

$$(bX^i) \cdot w := b \cdot (A^i(w)).$$

Also note that any \mathbb{R} -vector space section (of degree zero)

$$s: F \rightarrow W$$

of the surjective ring homomorphism ι (i.e. $\iota \circ s = I_F$) yields a B -module isomorphism

$$B \otimes_{\mathbb{R}} F \xrightarrow{\pi \otimes s} W$$

$$b \otimes f \longrightarrow \pi(b) \cdot s(f)$$

by conditions (i) and (ii), where the B -module structure on the tensor product is just multiplication in the first factor.

Let us fix a section of $\iota: W \rightarrow F$ as follows. First choose and fix *any* vector space section (of degree zero)

$$\tilde{s}: F \rightarrow W$$

and define the homogeneous subspace

$$\tilde{P} := \tilde{s}(P) \subset W$$

where $P \subset F$ is the primitive subspace of the Lefschetz algebra (F, τ) .

Define the homogeneous subspace

$$\tilde{F} = \bigoplus_{i=0}^{\lfloor \frac{f}{2} \rfloor} \left(\bigoplus_{j=0}^{f-2i} x^j \cdot \tilde{P}^i \right) \subset W.$$

Define a new vector space section (of degree zero)

$$F \xrightarrow{s} W$$

$$\tau^j \cdot p^i \longrightarrow x^j \cdot \tilde{s}(p^i)$$

(here p^i denotes an arbitrary element in P^i and τ^j (resp. x^j) denotes the element τ (resp. x) raised to the j^{th} power). We will write $\tilde{s}(p^i) = v^i$ for notational convenience. Thus we have fixed a B -module isomorphism

$$B \otimes_{\mathbb{R}} F \xrightarrow{\pi \otimes s} W$$

$$b \otimes f \longrightarrow \pi(b) \cdot s(f).$$

The tensor product comes with a “preferred” $B[X]$ -module structure defined by

$$(b'X^i) \cdot b \otimes f := b' \cdot b \otimes \tau^i \cdot f = (b' \otimes \tau^i) \cdot (b \otimes f).$$

We call this structure “preferred” because we know that

$$(B \otimes_{\mathbb{R}} F, \lambda \otimes 1 + 1 \otimes \tau)$$

is a Lefschetz algebra by Lemma 4.2.15. Note that the B -module homomorphism $\pi \otimes s$ is “almost” a $B[X]$ -module homomorphism.

The plan is to define a one-parameter family $A_t \in \text{End}_B^1(W)$ that will “continuously deform” the $B[X]$ -module structure on W from its given structure (where multiplication by X is multiplication by $x \in W^1$) into one that will make $\pi \otimes s$ a $B[X]$ -module isomorphism. Here are the details.

For each $t \in \mathbb{R}$ define the ring homomorphism

$$B \xrightarrow{\phi_t} B$$

$$b \longrightarrow t^{\deg(b)} \cdot b.$$

Note that ϕ_t is a ring *isomorphism* for $t \neq 0$ and

$$(\phi_t)^{-1} = \phi_{\frac{1}{t}}.$$

For each $t \in \mathbb{R}$, ϕ_t extends to a (twisted-) B -module homomorphism

$$W \xrightarrow{\hat{\phi}_t} W$$

in the sense that $\hat{\phi}_t(b \cdot w) = \phi_t(b) \cdot \hat{\phi}_t(w)$ for all $b \in B$ and $w \in W$.

Define the vector space maps

$$\hat{A}_{t,i}: \bigoplus_{j=0}^{f-2i} x^j \cdot \tilde{P}^i \rightarrow W[1]$$

by the formula

$$\hat{A}_{t,i}(x^j \cdot s(v^i)) = \begin{cases} x^{j+1} \cdot v^i & \text{if } j < f - 2i \\ \hat{\phi}_t(x^{f-2i+1} \cdot v^i) & \text{if } j = f - 2i. \end{cases}$$

For each $t \in \mathbb{R}$ this defines a vector space map

$$\hat{A}_t := \bigoplus_{i=0}^{\lfloor \frac{f}{2} \rfloor} \hat{A}_{t,i}: \tilde{F} \rightarrow W[1].$$

Since an \mathbb{R} -basis for \tilde{F} is a B -module basis for W , these extend B -linearly to W to define a one-parameter family

$$A_t: W \rightarrow W[1]$$

of B -module endomorphisms as desired.

Lemma 4.2.19. *There exist B -module homomorphisms $\chi_t: W \rightarrow W$ ($t \in \mathbb{R}$) such that the following diagram commutes:*

$$\begin{array}{ccc} W & \xleftarrow{\chi_t} & W \\ \downarrow tx & & \downarrow A_t \\ W[1] & \xleftarrow{\chi_t} & W[1] \end{array}$$

where the vertical map on the left is multiplication by the element $tx \in W^1$.

Proof. Define for each $t \in \mathbb{R}$ the graded \mathbb{R} -vector space maps

$$\begin{array}{ccc} \tilde{F} & \xrightarrow{\hat{\chi}_t} & \tilde{F} \\ x^j \cdot v^i & \longrightarrow & t^{j+i} x^j \cdot v^i. \end{array}$$

These maps extend uniquely to B -module endomorphisms

$$W \xrightarrow{\chi_t} W$$

$$b \cdot (x^j \cdot v^i) \longrightarrow b \cdot (t^{j+i} x^j \cdot v^i).$$

since W is free. The morphisms χ_t and $\hat{\phi}_t$ are related by the following composition law

$$\chi_t \circ \hat{\phi}_t(w) = t^{\deg(w)} w \quad \forall t \in \mathbb{R}. \quad (4.2.8)$$

Now we need to show that $\chi_t \circ A_t = (tx) \cdot \chi_t$ and it suffices to check this on (homogeneous) elements of W of the form $b \cdot (x^j \cdot v^i)$. For $t = 0$ we compute

$$\chi_0 \circ A_0(b \cdot (x^j \cdot v^i)) = \begin{cases} b \cdot 0 & \text{if } j < f - 2i \\ b \cdot \chi_0 \circ \hat{\phi}_0(x^{f-2i+1} \cdot v^i) & \text{if } j = f - 2i \end{cases}$$

which is clearly zero in light of (4.2.8). For $t \neq 0$ the B -module homomorphisms χ_t are actually B -module *isomorphisms* with

$$(\chi_t)^{-1} = \chi_{\frac{1}{t}}.$$

Hence we compute

$$\begin{aligned}
\chi_t \circ A_t \circ \chi_{\frac{1}{t}}(b \cdot x^j \cdot v^i) &= \chi_t \circ A_t \left(\frac{1}{t^{j+i}} b \cdot x^j \cdot v^i \right) \\
&= \begin{cases} \chi_t(t^{-j-i} b \cdot x^{j+1} \cdot v^i) & \text{if } j < f - 2i \\ \chi_t(t^{-f+i} b \cdot \hat{\phi}_t(x^{f-2i+1} \cdot v^i)) & \text{if } j = f - 2i \end{cases} \\
&= \begin{cases} tb \cdot x^{j+1} \cdot v^i & \text{if } j < f - 2i \\ t^{-f+i} b \cdot \chi_t \circ \hat{\phi}_t(x^{f-2i+1} \cdot v^i) & \text{if } j = f - 2i \end{cases} \\
&= \begin{cases} tb \cdot x^{j+1} \cdot v^i & \text{if } j < f - 2i \\ tb \cdot (x^{f-2i+1} \cdot v^i) & \text{if } j = f - 2i \end{cases} \\
&= tx \cdot (b \cdot (x^j \cdot v^i));
\end{aligned}$$

the second to last equality follows from (4.2.8). Hence

$$\chi_t \circ A_t \circ \chi_{\frac{1}{t}} = tx \tag{4.2.9}$$

and the diagram commutes for every $t \in \mathbb{R}$. This completes the proof of Lemma 4.2.19. \square

(4.2.9) can be interpreted as a B -module change of base formula for $t \neq 0$.

Lemma 4.2.20. *At $t = 0$ there is another commutative diagram:*

$$\begin{array}{ccc}
W & \xleftarrow{\pi \otimes s} & (B \otimes_{\mathbb{R}} F) \\
A_0 \downarrow & & \downarrow 1 \otimes \tau \\
W[1] & \xleftarrow{\pi \otimes s} & (B \otimes F)[1].
\end{array}$$

Proof. As before, it suffices to check this for simple tensors of the form $b \otimes \tau^j p^i$ where τ^j is the (fixed) Lefschetz element $\tau \in F^1$ raised to the j^{th} power and p^i is an arbitrary element in P^i , the i^{th} graded piece of the primitive subspace of the pair (F, τ) .

We compute

$$A_0 \circ (\pi \otimes s)(b \otimes \tau^j p^i) = \begin{cases} \pi(b) \cdot x^{j+1} s(p^i) & \text{if } j < f - 2i \\ \pi(b) \cdot \hat{\phi}_0(x^{f-2i+1} s(p^i)) & \text{if } j = f - 2i. \end{cases} \quad (4.2.10)$$

Recall that $\iota(x^{f-2i+1} s(p^i)) = \tau^{f-2i+1} p^i = 0$, hence by assumption (ii), $x^{f-2i+1} s(p^i) \in B^+ W$; but $\hat{\phi}_0(B^+ W) = 0$. Applying this observation to (4.2.10) we get

$$A_0 \circ (\pi \otimes s)(b \otimes \tau^j p^i) = \begin{cases} \pi(b) \cdot x^{j+1} s(p^i) & \text{if } j < f - 2i \\ 0 & \text{if } j = f - 2i. \end{cases} \quad (4.2.11)$$

On the other hand we compute

$$(\pi \otimes s) \circ (1 \otimes \tau)(b \otimes \tau^j p^i) = \begin{cases} \pi(b) \cdot x^{j+1} s(p^i) & \text{if } j < f - 2i \\ 0 & \text{if } j = f - 2i. \end{cases} \quad (4.2.12)$$

Hence the diagram commutes and this completes the proof of Lemma 4.2.20. \square

We are now in a position to prove Theorem 4.2.16.

Proof of Theorem 4.2.16. Consider the \mathbb{R} -vector space map

$$\Lambda + A_t \in \text{End}_{\mathbb{R}}^1(W)$$

where

$$\Lambda: W \rightarrow W[1]$$

is the map “multiplication by $\pi(\lambda)$ ”. Note that $\chi_t \circ \Lambda = \Lambda \circ \chi_t$ for all $t \in \mathbb{R}$. Assume for the moment that for some fixed $t \neq 0$ and for each $0 \leq k \leq \lfloor \frac{w}{2} \rfloor$, the map

$$(\Lambda + A_t)^{w-2k}: W^k \rightarrow W^{w-k}$$

is an isomorphism. Then by the commutivity of the diagram

$$\begin{array}{ccc}
 W & \xleftarrow{\chi_t} & W \\
 \downarrow \pi(\lambda)+tx & & \downarrow \Lambda+A_t \\
 W[1] & \xleftarrow{\chi_t} & W[1]
 \end{array}$$

the pair $(W, \pi(\lambda) + tx)$ is a Lefschetz algebra. Therefore it suffices to show that there is some $t \neq 0$ such that

$$(\Lambda + A_t)^{w-2k} : W^k \rightarrow W^{w-k}$$

is an isomorphism for all $0 \leq k \leq \lfloor \frac{w}{2} \rfloor$.

By the commutativity of the diagram

$$\begin{array}{ccc}
 (B \otimes_{\mathbb{R}} F) & \xrightarrow{\pi \otimes s} & W \\
 \downarrow \lambda \otimes 1 + 1 \otimes \tau & & \downarrow \Lambda + A_0 \\
 (B \otimes F)[1] & \xrightarrow{\pi \otimes s} & W[1]
 \end{array}$$

and since

$$((B \otimes_{\mathbb{R}} F), \lambda \otimes 1 + 1 \otimes \tau)$$

is a Lefschetz algebra (by Lemma 4.2.15), we deduce that for each $0 \leq k \leq \lfloor \frac{w}{2} \rfloor$ the maps

$$(\Lambda + A_0)^{w-2k} : W^k \rightarrow W^{w-k}$$

are isomorphisms. Hence by the ‘‘principle of continuity’’ we conclude that there must be *some* value of t_0 different from zero such that the maps

$$(\Lambda + A_{t_0})^{w-2k} : W^k \rightarrow W^{w-k}$$

are isomorphisms (this ‘‘principle of continuity’’ can be made precise as follows: one first observes that $\det((\Lambda + A_t)^{w-2k})$ is continuous in t (in fact it is a polynomial). Then since

$\det((\Lambda + A_0)^{w-2k})$ is non-zero (by Lemma 4.2.15), one concludes that $\det((\Lambda + A_t)^{w-2k})$ is not identically zero as a function of t ; hence there is some value $t_0 \neq 0$ such that $\det((\Lambda + A_{t_0})^{w-2k})$ is non-zero. This proves that $(W, \pi(\lambda) + t_0 x)$ is a Lefschetz algebra, and hence completes the proof of Theorem 4.2.16. \square

4.3 The Blow-Up

In this section we recall the notion of the blow-up of a 1-skeleton along a sub-skeleton. This construction is due to Guillemin and Zara and we will try to adhere to their notation in [14] as much as possible. In the first part we briefly recall this construction (from chapter 2) and then describe a decomposition of the cohomology ring of the blow-up (also due to Guillemin and Zara) in terms of the cohomology of the original 1-skeleta and the sub-skeleton. We follow the same approach as in the case of fiber bundles: first prove the result for equivariant cohomology, then derive the result for ordinary cohomology as a formal consequence.

In the next part we prove an algebraic result that will imply, together with the decomposition theorem above, that the blow-up of a 1-skeleton with the Lefschetz package along a sub-skeleton with the Lefschetz package will itself have the Lefschetz package.

Fix a d -valent 1-skeleton with connection $(\Gamma, \alpha, \theta) \subset \mathbb{R}^n$ with compatibility system $\{\lambda_e\}_{e \in E_\Gamma}$ and a k -valent totally geodesic, level sub-skeleton $(\Gamma_0, \alpha_0, \theta_0)$. Let $N^0 \subset E_\Gamma$ denote the oriented edges that are normal to Γ_0 . Since the sub-skeleton is level we choose (and fix) a *blow-up system*, or a map

$$n: N^0 \rightarrow \mathbb{R}_+$$

that satisfy the condition that for every $e \in E_0$ and every $e' \in N^0$

$$\frac{n(e)}{n(\theta_e(e'))} = \lambda_e(e').$$

Define the vertex set of Γ^\sharp to be

$$V^\sharp := V_\Gamma \setminus V_0 \sqcup N^0.$$

Write z_e to denote a vertex corresponding to an oriented edge $e \in N^0$ or write z_e^p to denote the vertex corresponding to $e \in N_p^0$.

There is a natural map of sets

$$\beta: V^\sharp \rightarrow V_\Gamma$$

defined by

$$\beta(x) = \begin{cases} q & \text{if } x = q \in V_\Gamma \setminus V_0 \\ p & \text{if } x = z_e \text{ for some } e \in N_p^0 \end{cases} \quad (4.3.1)$$

We declare two vertices $x, y \in V_\Gamma^\sharp$ to be adjacent if $\beta(x) = \beta(y)$ or $\overline{\beta(x)\beta(y)} \in E_\Gamma$. Denote this oriented edge set E^\sharp .

There is a natural choice for connection θ^\sharp on Γ^\sharp . Furthermore, using the (fixed) blow-up system $n: N^0 \rightarrow \mathbb{R}_+$ there is a natural choice for a (generalized) axial function α^\sharp for the pair $(\Gamma^\sharp, \theta^\sharp)$ defined by

$$\alpha^\sharp(\epsilon) = \begin{cases} \alpha(\beta(\epsilon)) & \text{if } \epsilon \in (E^\sharp)^h \\ n(e)\alpha(e') - n(e')\alpha(e) & \text{if } \epsilon = \overline{z_e z_{e'}} \in (E^\sharp)^v. \end{cases} \quad (4.3.2)$$

For the remainder of this chapter, we will assume that α^\sharp is 2-independent (i.e. α^\sharp is an axial function for $(\Gamma^\sharp, \theta^\sharp)$).

The resulting 1-skeleton with connection $(\Gamma^\sharp, \alpha^\sharp, \theta^\sharp)$ is called the *blow-up* of (Γ, α, θ) along $(\Gamma_0, \alpha_0, \theta_0)$. Moreover the sub-graph $\Gamma_0^\sharp \subset \Gamma^\sharp$ is the graph of a totally geodesic sub-skeleton $(\Gamma_0^\sharp, \alpha_0^\sharp, \theta_0^\sharp)$ called the *singular locus* of the blow-up.

The map β extends to a morphism of 1-skeleta with connections

$$\beta = (\beta_G, I_{\mathbb{R}}^n): (\Gamma^\sharp, \alpha^\sharp, \theta^\sharp) \rightarrow (\Gamma, \alpha, \theta)$$

called the *blow-down* morphism (here we have used β_G to denote the graph morphism defined in (4.3.1)). The restriction of β to the singular locus

$$\beta_0: (\Gamma_0^\sharp, \alpha_0^\sharp, \theta_0^\sharp) \rightarrow (\Gamma_0, \alpha_0, \theta_0)$$

is a pseudo-fiber bundle of 1-skeleta with connections whose fibers are complete 1-skeleta on the $(d - k)$ vertices corresponding to N_p^0 , for $p \in V_0$.

4.3.1 Cohomology of the Blow-Up

The singular locus is a level sub-skeleton (of co-valence 1) of the blow-up, hence there is an equivariant Thom class $\tau \in H^1(\Gamma^\sharp, \alpha^\sharp)$. A natural choice for such a Thom class is the following:

$$\tau(p) = \begin{cases} \frac{1}{n(e)}\alpha(e) & \text{if } p = z_e \in N^0 \\ 0 & \text{otherwise.} \end{cases}$$

Write $\tau_0 \in H^1(\Gamma_0^\sharp, \alpha_0^\sharp)$ for the restriction of τ to the singular locus. For any equivariant class $h \in H(\Gamma_0^\sharp, \alpha_0^\sharp)$, the class $\tau_0 \cdot h \in H(\Gamma_0^\sharp, \alpha_0^\sharp)$ can be “extended by zero” to a class on $(\Gamma^\sharp, \alpha^\sharp)$ that we express as $\tau \cdot h$. We are abusing notation here slightly since h is not really a class in $H(\Gamma^\sharp, \alpha^\sharp)$; however if h extends to a class $H \in H(\Gamma^\sharp, \alpha^\sharp)$, then we can write $\tau \cdot h$ as a “true” product of classes $\tau \cdot H$.

The blow-down morphism $\beta: (\Gamma^\sharp, \alpha^\sharp, \theta^\sharp) \rightarrow (\Gamma, \alpha, \theta)$ induces an inclusion of equivariant cohomology rings

$$\beta^*: H(\Gamma, \alpha) \rightarrow H(\Gamma^\sharp, \alpha^\sharp),$$

and this gives $H(\Gamma^\sharp, \alpha^\sharp)$ the structure of a $H(\Gamma, \alpha)$ -module. The image of β^* in $H(\Gamma^\sharp, \alpha^\sharp)$ is the set of classes that are constant over the fibers of β . The restriction of β to the

singular locus gives an inclusion

$$\beta_0^*: H(\Gamma_0, \alpha_0) \rightarrow H(\Gamma_0^\sharp, \alpha_0^\sharp),$$

and hence gives $H(\Gamma_0^\sharp, \alpha_0^\sharp)$ the structure of a $H(\Gamma_0, \alpha_0)$ -module. The natural inclusion morphism

$$\rho: (\Gamma_0, \alpha_0, \theta_0) \rightarrow (\Gamma, \alpha, \theta)$$

induces a restriction homomorphism

$$\rho^*: H(\Gamma, \alpha) \rightarrow H(\Gamma_0, \alpha_0),$$

that gives $H(\Gamma_0, \alpha_0)$ the structure of a $H(\Gamma, \alpha)$ -module.

We have the following decomposition theorem for the equivariant cohomology of the blow-up, due to Guillemin and Zara (cf. [14], Theorem 2.2.1).

Theorem 4.3.1. *For every class $F \in H(\Gamma^\sharp, \alpha^\sharp)$ there exist unique classes $f_0 \in H(\Gamma, \alpha)$ and $g_i \in H(\Gamma_0, \alpha_0)$ such that*

$$F = \beta^*(f_0) + \sum_{i=1}^{d-k-1} \beta_0^*(g_i)\tau^i,$$

where the classes in the sum on the right are classes in $H(\Gamma_0^\sharp, \alpha_0^\sharp)$ extended by zero to classes in $H(\Gamma^\sharp, \alpha^\sharp)$.

Equivalently, the map

$$H(\Gamma, \alpha) \oplus \left(\bigoplus_{i=1}^{d-k-1} H(\Gamma_0, \alpha_0)\tau_0^i \right) \xrightarrow{\Psi} H(\Gamma^\sharp, \alpha^\sharp) \quad (4.3.3)$$

$$(f_0, \sum g_i\tau_0^i) \longrightarrow \beta^*(f_0) + \sum \beta_0^*(g_i)\tau^i$$

is an $H(\Gamma, \alpha)$ -module isomorphism where the $H(\Gamma, \alpha)$ -module structure on the direct sum is component wise-on the first factor by multiplication in $H(\Gamma, \alpha)$, and on the second factor by restriction (via ρ^*)- and the $H(\Gamma, \alpha)$ -module structure on $H(\Gamma^\sharp, \alpha^\sharp)$ is given by β^* .

We will need the following lemma due to Guillemin and Zara in [16].

Lemma 4.3.2. *Let $(\Gamma', \alpha') \subset \mathbb{R}^n$ be a complete 1-skeleton on s vertices and let $\tau' : V_{\Gamma'} \rightarrow \mathbb{R}^n$ be an injective function that is an equivariant class of degree 1 on (Γ', α') . Then $\{(\tau')^i\}_{i=0}^{s-1}$ is an S -basis for $H(\Gamma', \alpha')$.*

Proof. See [16], Theorem 4.1. □

Proof of Theorem 4.3.1. Fix $v \in V_{\Gamma_0}$ and set $(\Gamma', \alpha') = (\beta_0)^{-1}(v)$. Let $\tau' : V_{\Gamma'} \rightarrow \mathbb{R}^n$ denote the equivariant class of degree 1 that is the restriction of the Thom class $\tau_0 \in H^1(\Gamma_0^\sharp, \alpha_0^\sharp)$ to the fiber $(\beta_0)^{-1}(v)$. By the definition of τ_0 , τ' is an injective function, hence by Lemma 4.3.2 the classes

$$\{(\tau')^i\}_{i=0}^{s-1}$$

are an S -basis for $H(\Gamma', \alpha')$, where $s = d - k$. Now we have a pseudo-fiber bundle of 1-skeleta with connections

$$\begin{array}{ccc} (\beta_0)^{-1}(v) & \xrightarrow{i_v} & (\Gamma_0^\sharp, \alpha_0^\sharp, \theta_0^\sharp) \\ & & \downarrow \beta_0 \\ & & (\Gamma_0, \alpha_0, \theta_0), \end{array}$$

and by Theorem 4.2.6 we deduce that $\{\tau_0^i\}_{i=0}^{s-1}$ are a $H(\Gamma_0, \alpha_0)$ -basis for $H(\Gamma_0^\sharp, \alpha_0^\sharp)$. This means that any class $f \in H(\Gamma_0^\sharp, \alpha_0^\sharp)$ can be written as

$$f = \sum_{i=0}^{s-1} \beta_0^*(g_i) \tau_0^i \tag{4.3.4}$$

for some unique $g_i \in H(\Gamma_0, \alpha_0)$.

Now let $F \in H(\Gamma^\sharp, \alpha^\sharp)$ be any equivariant class and let $f \in H(\Gamma_0^\sharp, \alpha_0^\sharp)$ be its restriction to the singular locus. (4.3.4) gives

$$f = \sum_{i=0}^{s-1} \beta_0^*(g_i) \tau_0^i = g_0 + \sum_{i=1}^{s-1} \beta_0^*(g_i) \tau_0^i.$$

The second summand on the RHS can be “extended by zero” to an equivariant class

$$G := \sum_{i=1}^{s-1} \beta_0^*(g_i) \tau^i \in H(\Gamma^\sharp, \alpha^\sharp). \quad (4.3.5)$$

The class $F - G \in H(\Gamma^\sharp, \alpha^\sharp)$ is constant on the fibers of β , hence we must have $F - G = \beta^*(F_0)$ for some $F_0 \in H(\Gamma, \alpha)$. This shows the existence of the decomposition.

To prove uniqueness, suppose that

$$\beta^*(F_0) + \sum_{i=1}^{s-1} \beta_0^*(g_i) \tau^i = 0$$

for some $F_0 \in H(\Gamma, \alpha)$ and some $g_i \in H(\Gamma_0, \alpha_0)$. Then its restriction to the singular locus is also zero and Theorem 4.2.6 implies that the g_i 's are all zero. Hence $\beta^*(F_0) = 0$, but β^* is injective so we must have $F_0 = 0$ as well.

This completes the proof of Theorem 4.3.1. □

Remark. *If the restriction map $\rho^*: H(\Gamma, \alpha) \rightarrow H(\Gamma_0, \alpha_0)$ is surjective then for each $i > 0$ and each $g_i \in H(\Gamma_0, \alpha_0)$, the class $\beta_0^*(g_i) \tau_0^i$ extends to a class $\beta^*(G_i) \tau^i$ where $G_i \in H(\Gamma, \alpha)$ and $\rho^*(G_i) = g_i$. In general it may not be possible to “divide by τ^i ”. In the sequel, we will assume that ρ^* is surjective.*

Corollary 4.3.3. *The map*

$$\overline{H(\Gamma, \alpha)} \oplus \left(\bigoplus_{i=1}^s \overline{H(\Gamma_0, \alpha_0)} \tau_0^i \right) \xrightarrow{\bar{\Psi}} \overline{H(\Gamma^\sharp, \alpha^\sharp)}$$

$$(\bar{f}_0, \sum \bar{g}_i \tau_0^i) \longrightarrow \bar{\beta}^*(\bar{f}_0) + \sum \bar{\beta}_0^*(\bar{g}_i) \tau^i$$

is an $\overline{H(\Gamma, \alpha)}$ -module isomorphism.

Proof. Apply the functor $- \otimes_S \mathbb{R}$ to both sides of (4.3.3). □

4.3.2 Lefschetz Package for the Blow-Up

We now come to the main result of this section. Following the same strategy as in the case of fiber bundles, we break the result into two pieces: First, we give an algebraic result in the language of Lefschetz algebras. Then we show how this implies the main result that says “the blow-up 1-skeleton of a 1-skeleton with the Lefschetz package along a level sub-skeleton with the Lefschetz package also has the Lefschetz package”. Throughout this section all homomorphisms are graded of degree zero unless otherwise indicated. We use the notation $R[i]$ to denote the graded object R shifted down by i (i.e. $(R[i])^j = R^{j+i}$).

For each $n \geq 0$ let

$$P(n) := \mathbb{R}[Y]/\langle Y^n \rangle \cong \bigoplus_{i=0}^{n-1} \mathbb{R} \cdot Y^i$$

with the usual grading and

$$P^+(n) := \bigoplus_{i=1}^{n-1} \mathbb{R} \cdot Y^i,$$

the ideal generated by those elements of positive degree.

Let

$$B = \bigoplus_{i=0}^b B^i$$

and

$$U = \bigoplus_{j=0}^u U^j$$

be \mathbb{N} -graded Artinian \mathbb{R} -algebras and let

$$\rho: U \rightarrow B$$

be a graded \mathbb{R} -algebra homomorphism. Define the \mathbb{N} -graded ring

$$W := P^+(s) \otimes_{\mathbb{R}} B \cong \bigoplus_{k=1}^{s-1} Y^k \otimes_{\mathbb{R}} B;$$

W is an ideal of the \mathbb{N} -graded Artinian \mathbb{R} -algebra $P(s) \otimes_{\mathbb{R}} B$ that has the structure of a free B -module with the basis $\{Y^k\}_{k=1}^{s-1}$, where $s + b = u$. Set $w = b + (s - 1) = u - 1$; then $W = \bigoplus_{k=1}^w W^k$. The map ρ gives W the structure of a U -module, hence we can form the direct sum of U -modules

$$U \oplus W;$$

this direct sum is naturally an \mathbb{N} -graded Artinian \mathbb{R} -algebra where multiplication is defined by

$$(u, w) \cdot (u', w') = (u \cdot u', u' \cdot w + u \cdot w' + w \cdot w').$$

Endow this direct sum with the *standard* $U[X]$ -module structure by the prescription

$$X \cdot (u, w) := (0, Y \otimes \rho(u) + Y \cdot w) = (0, Y \cdot (1 \otimes \rho(u) + w)). \quad (4.3.6)$$

We have the following preliminary result.

Lemma 4.3.4. *Suppose (B, λ) and (U, Λ) are Lefschetz algebras with*

$$\rho(\Lambda) = \lambda.$$

Then $(U \oplus W, \Lambda + X)$ is a Lefschetz algebra, where X is the operator in (4.3.6).

Proof. We need to show that the maps

$$(\Lambda + X)^{u-2m} : (U^m \oplus W^m) \rightarrow (U^{u-m} \oplus W^{u-m}) \quad (4.3.7)$$

are isomorphisms for $0 \leq m \leq \lfloor \frac{u}{2} \rfloor$. The crucial observation to make is that the homogeneous subspace

$$\{0\} \oplus W \subset U \oplus W$$

is actually a $U[X]$ -sub-module. Choose a homogeneous basis of U and a homogeneous basis for W to get a homogeneous basis for the direct sum $U \oplus W$. We compute the matrix

for the linear map (4.3.7) in terms of this basis: it has the form

$$\begin{pmatrix} \Lambda^{u-2m} & 0 \\ * & (\lambda + Y)^{w-2m+1} \end{pmatrix}.$$

Since we are assuming that the map

$$\Lambda^{u-2m} : U^m \rightarrow U^{u-m}$$

is an isomorphism, it suffices to prove that

$$(\lambda + Y)^{w-2m+1} : W^m \rightarrow W^{w-m+1} \quad (4.3.8)$$

is an isomorphism (remember that $u = w + 1$ here).

Define the $\mathbb{R}[Y]$ -module isomorphism

$$P^+(s) \xrightarrow{\hat{\pi}} P(s-1)[-1] \quad (4.3.9)$$

$$Y^i \longrightarrow Y^{i-1}.$$

This extends formally to a $B[Y]$ -module isomorphism

$$W \xrightarrow{\pi} (P(s-1) \otimes_{\mathbb{R}} B)[-1] \quad (4.3.10)$$

$$Y^i \otimes b \longrightarrow Y^{i-1} \otimes b.$$

Thus we have the commutative diagram

$$\begin{array}{ccc} W^m & \xrightarrow[\cong]{\pi} & (P(s-1) \otimes_{\mathbb{R}} B)^{m-1} \\ \downarrow (\lambda+Y)^{w-2m+1} & & \downarrow \cong (\lambda+Y)^{(w-1)-2(m-1)} \\ W^{w-m+1} & \xrightarrow[\cong]{\pi} & (P(s-1) \otimes_{\mathbb{R}} B)^{(w-1)-(m-1)}. \end{array}$$

Lemma 4.2.15 implies that the right vertical map is an isomorphism, hence the left vertical map must also be an isomorphism. Thus (4.3.8) is an isomorphism and therefore (4.3.7) is an isomorphism. This completes the proof of Lemma 4.3.4. \square

Remark. If the map $\rho: U \rightarrow B$ is surjective, and if U and B both have the strong Lefschetz property, then it is always possible to find a Lefschetz element $\Lambda \in U^1$ for U such that $\rho(\Lambda) = \lambda \in B^1$ is a Lefschetz element for B . Indeed the set of such $\Lambda \in U^1$ is the intersection of two non-empty Zariski-open sets.

Here is the main (algebraic) result.

Theorem 4.3.5. Let B , U , and W be as in Lemma 4.3.4 and assume the \mathbb{R} -algebra map $\rho: U \rightarrow B$ is surjective. Let $E = \bigoplus_{i \geq 0} E^i$ be an \mathbb{N} -graded Artinian \mathbb{R} -algebra and suppose there is an \mathbb{R} -algebra homomorphism $\beta: U \rightarrow E$ and a U -module homomorphism $\chi: W \rightarrow E$, (the U -module structure on E given by β) such that

$$i. \chi(Y^i \otimes b) = \chi(Y \otimes 1) \cdot \chi(Y^{i-1} \otimes b) \text{ for } 1 < i < s$$

ii. the map

$$U \oplus W \xrightarrow{\beta \oplus \chi} E$$

$$(u, w) \longmapsto \beta(u) + \chi(w)$$

is an isomorphism of U -modules. Then $(E, \beta(\Lambda) + t\chi(Y \otimes 1))$ is a Lefschetz algebra for some $t \neq 0$, where $\Lambda \in U^1$ is a Lefschetz element for U such that $\rho(\Lambda) = \lambda \in B^1$ is Lefschetz for B .

Proof. For notational convenience let

$$\tau := \chi(Y \otimes 1) \in E^1.$$

E is endowed with a “natural” $U[X]$ -module structure by the prescription

$$(u \cdot X^i) \cdot e := \beta(u) \cdot \tau^i \cdot e \tag{4.3.11}$$

where the dots on the right hand side denote multiplication in E . Fix a homogeneous \mathbb{R} -vector space section $\sigma: B \rightarrow U$ of ρ (which exists since ρ is surjective). Note that for any $b \in B$ and $1 \leq i \leq s - 1$ we have

$$\chi(Y^i \otimes b) = \beta(\sigma(b)) \cdot \chi(Y^i \otimes 1) = \beta(\sigma(b)) \cdot \tau^i \quad (4.3.12)$$

where the first equality follows from the assumption that χ is a U -module homomorphism, and the second follows from the assumption (i) in the statement of the theorem. Furthermore any element $A \in \text{End}_U^1(E)$ defines another $U[X]$ -module structure on E by

$$(u \cdot X^i) \cdot e := \beta(u) \cdot A^i(e).$$

The idea is to find a 1-parameter family $A_t \in \text{End}_U^1(E)$ that will “continuously deform” the $U[X]$ -module structure on E from the “natural” one in (4.3.11) above to that of the standard one on $U \oplus W$ as in Lemma 4.3.4. Here are the details.

For each $t \in \mathbb{R}$ define the \mathbb{R} -vector space map

$$\begin{aligned} E &\xrightarrow{\Phi_t} E \\ \beta(u) + \chi(Y^i \otimes b) &\longrightarrow t^{\deg(u)}\beta(u) + t^{\deg(b)}\chi(Y^i \otimes b). \end{aligned}$$

This map is well defined by (ii) in the statement of Theorem 4.3.5.

Next define, for each $t \in \mathbb{R}$, the U -module homomorphism

$$E \xrightarrow{A_t} E$$

by

$$A_t(\beta(u) + \chi(Y^i \otimes b)) := \beta(u) \cdot \tau + \beta(\sigma(b)) \cdot \Phi_t(\tau^{i+1}).$$

Note that for $i < s - 1$, $\Phi_t(\tau^{i+1}) = \tau^{i+1}$. Thus for $i < s - 1$ applying A_t to $\beta(u) + \chi(Y^i \otimes b)$ is the same as multiplying by τ .

Define the intermediary U -module homomorphisms

$$E \xrightarrow{\gamma_t} E$$

$$\beta(u) + \chi(Y^i \otimes b) \longrightarrow \beta(u) + t^i \chi(Y^i \otimes b).$$

One can easily check that γ_t and Φ_t are related by the formula

$$\gamma_t \circ \Phi_t(e) = t^{\deg(e)} \cdot e \quad \forall e \in E. \quad (4.3.13)$$

The following claim establishes a relationship between the $U[X]$ -module on E with respect to multiplication by (\mathbb{R} -multiples of) τ , and the $U[X]$ -module structure on E with respect to $A_t \in \text{End}_U^1(E)$.

Claim. *The following diagram commutes:*

$$\begin{array}{ccc} E & \xleftarrow{\gamma_t} & E \\ \tau \downarrow & & \downarrow A_t \\ E[1] & \xleftarrow{\gamma_t} & E[1] \end{array} \quad (4.3.14)$$

where the left vertical map is multiplication by the element $t\tau \in E^1$.

For $t = 0$ we have $\gamma_0 \circ A_0 = 0 = 0 \cdot \gamma_0$. For $t \neq 0$ note that γ_t is an isomorphism and that $(\gamma_t)^{-1} = \gamma_{\frac{1}{t}}$. We compute:

For $i < s - 1$:

$$\begin{aligned} \gamma_t \circ A_t \circ \gamma_{\frac{1}{t}}(\beta(u) + \chi(Y^i \otimes b)) &= \gamma_t \circ A_t(\beta(u) + t^{-i} \chi(Y^i \otimes b)) \\ &= \gamma_t(\beta(u) \cdot \tau + t^{-i} \tau \cdot \chi(Y^i \otimes b)) \\ &= \gamma_t(\chi(Y \otimes \rho(u)) + t^{-i} \chi(Y^{i+1} \otimes b)) \\ &= t \cdot \chi(Y \otimes \rho(u)) + t^{-i} \cdot t^{i+1} \chi(Y^{i+1} \otimes b) \\ &= t \chi(Y \otimes \rho(u)) + t \chi(Y^{i+1} \otimes b) \\ &= t \beta(u) \cdot \tau + t \tau \cdot \chi(Y^i \otimes b). \end{aligned}$$

For $i = s - 1$:

$$\begin{aligned}
\gamma_t \circ A_t \circ \gamma_t^{-1}(\beta(u) + \chi(Y^{s-1} \otimes b)) &= \gamma_t \circ A_t(\beta(u) + t^{-s+1}\chi(Y^{s-1} \otimes b)) \\
&= \gamma_t(\beta(u) \cdot \tau + t^{-s+1}\beta(\sigma(b)) \cdot \Phi_t(\tau^s)) \\
&= \gamma_t(\chi(Y \otimes \rho(u))) + t^{-s+1}\beta(\sigma(b)) \cdot \gamma_t \circ \Phi_t(\tau^s) \\
&= t\chi(Y \otimes \rho(u)) + t\beta(\sigma(b)) \cdot \tau^s \\
&= t\beta(u) \cdot \tau + t\tau \cdot \chi(Y^{s-1} \otimes b).
\end{aligned}$$

This establishes the claim.

The next claim establishes a relationship between the standard $U[X]$ -module structure on $U \oplus W$ and the $U[X]$ -module structure on E with respect to $A_0 \in \text{End}_U^1(E)$.

Claim. *The following diagram commutes*

$$\begin{array}{ccc}
U \oplus W & \xrightarrow{\beta \oplus \chi} & E \\
\downarrow X & & \downarrow A_0 \\
(U \oplus W)[1] & \xrightarrow{\beta \oplus \chi} & E[1]
\end{array} \tag{4.3.15}$$

where the left vertical map is multiplication by “ X ” as in (4.3.6).

The crucial observation here is that $\Phi_0(\tau^s) = 0$. The point is that

$$\tau^s = \beta(u) + \chi\left(\sum_{i=1}^{s-1} Y^i \otimes b_i\right)$$

where $\deg(u) = s > 0$ and $\deg(b_i) = s - i > 0$.

We compute

$$\begin{aligned}
A_0(\beta(u) + \chi(Y^i \otimes b)) &= \beta(u) \cdot \tau + \begin{cases} \tau \cdot \chi(Y^i \otimes b) & \text{if } i < s-1 \\ \beta(\sigma(b)) \cdot \Phi_0(\tau^s) & \text{if } i = s \end{cases} \\
&= \tau \cdot \beta(u) + \begin{cases} \beta(\sigma(b)) \cdot \tau^{i+1} & \text{if } i < s-1 \\ 0 & \text{if } i = s \end{cases} \\
&= \chi(Y \otimes \rho(u)) + \chi(Y^{i+1} \otimes b) \\
&= \beta \oplus \chi(X \cdot (u, Y^i \otimes b))
\end{aligned}$$

which establishes the claim.

We are now in a position to finish up the argument. Suppose that

$$E = \bigoplus_{l=0}^e E^l.$$

Then $e = w + 1 = b + s$. For fixed $0 \leq m \leq \lfloor \frac{e}{2} \rfloor$ we want to show that the linear maps

$$(\beta(\Lambda) + t\tau)^{e-2m} : E^m \rightarrow E^{e-m}$$

are isomorphisms for some fixed value of $t \neq 0$. Note that for all $t \in \mathbb{R}$ we have $\gamma_t(\beta(\Lambda)) = \beta(\Lambda)$. Thus since (4.3.14) commutes the following diagram must also commute:

$$\begin{array}{ccc}
E & \xleftarrow{\gamma_t} & E \\
(\beta(\Lambda) + t\tau) \downarrow & & \downarrow (\beta(\Lambda) + A_t) \\
E[1] & \xleftarrow{\gamma_t} & E[1].
\end{array}$$

Therefore it suffices to show that for some fixed value of $t \neq 0$, the maps

$$(\beta(\Lambda) + A_t)^{e-2m} : E^m \rightarrow E^{e-m} \tag{4.3.16}$$

are isomorphisms for all $0 \leq m \leq \lfloor \frac{e}{2} \rfloor$.

By the commutativity of the diagram in (4.3.15) the following diagram also commutes:

$$\begin{array}{ccc}
 U \oplus W & \xrightarrow{\beta \oplus \chi} & E \\
 (\Lambda + X) \downarrow & & \downarrow (\beta(\Lambda) + A_0) \\
 (U \oplus W)[1] & \xrightarrow{\beta \oplus \chi} & E[1].
 \end{array}$$

Therefore by Lemma 4.3.4 the maps in (4.3.16) must be isomorphisms for $t = 0$.

Hence by the ‘‘principle of continuity’’ there is some value $t_0 \neq 0$ at which the maps in (4.3.16) are isomorphisms. Therefore $(E, \beta(\Lambda) + t_0\tau)$ is a Lefschetz algebra and this completes the proof of Theorem 4.3.5. \square

We use the above algebraic result to give the formulation of the main result in terms of 1-skeleta and cohomology rings. As above we fix a d -valent 1-skeleton (Γ, α, θ) and a k -valent sub-skeleton $(\Gamma_0, \alpha_0, \theta_0)$ and let $(\Gamma^\sharp, \alpha^\sharp, \theta^\sharp)$ denote the blow-up of (Γ, α, θ) along $(\Gamma_0, \alpha_0, \theta_0)$ using any fixed blow-up system $n: N^0 \rightarrow \mathbb{R}_+$. Let

$$\beta: (\Gamma^\sharp, \alpha^\sharp, \theta^\sharp) \rightarrow (\Gamma, \alpha, \theta)$$

denote the blow-down morphism and let $(\Gamma_0^\sharp, \alpha_0^\sharp, \theta_0^\sharp)$ be the singular locus. Let

$$\rho: (\Gamma_0, \alpha_0, \theta_0) \rightarrow (\Gamma, \alpha, \theta)$$

denote the natural inclusion.

Here is the main result.

Theorem 4.3.6. *Suppose that (Γ, α, θ) and $(\Gamma_0, \alpha_0, \theta_0)$ have the Lefschetz package. Furthermore assume that the restriction map $\rho^*: H(\Gamma, \alpha) \rightarrow H(\Gamma_0, \alpha_0)$ is surjective. Then $(\Gamma^\sharp, \alpha^\sharp, \theta^\sharp)$ also has the Lefschetz package.*

Proof. Let

$$U := \overline{H(\Gamma, \alpha)}$$

$$B := \overline{H(\Gamma_0, \alpha_0)}$$

$$W := \bigoplus_{i=1}^{s-1} \overline{H(\Gamma_0, \alpha_0) \tau_0^i}$$

and

$$E := \overline{H(\Gamma^\sharp, \alpha^\sharp)}.$$

Let

$$\rho := \rho^* : U \rightarrow B$$

denote the restriction map and let

$$\beta := \beta^* : U \rightarrow E$$

denote the map induced from the blow-down morphism. Let

$$\chi : W \rightarrow E$$

denote the map “extension by zero” as in the assertion of Theorem 4.3.1. Note that χ is a U -module homomorphism and since ρ^* is surjective every class of the form $\beta_0^*(g) \cdot \tau_0^i$ extends by zero to a class of the form $\beta(G) \cdot \tau^i$. Thus χ satisfies condition (i) in the statement of Theorem 4.3.5. Also by Theorem 4.3.3, the map

$$U \oplus W \xrightarrow{\beta \oplus \chi} E$$

is an isomorphism of U -modules (so condition (ii) is also satisfied). Hence we can apply Theorem 4.3.5 to conclude that $(\Gamma^\sharp, \alpha^\sharp, \theta^\sharp)$ has the Lefschetz package with Lefschetz element given by $(\beta(\Lambda) + t_0\tau) \in \overline{H^1(\Gamma^\sharp, \alpha^\sharp)}$ for some $t_0 \neq 0$, where Λ is a Lefschetz element for U whose restriction $\rho^*(\Lambda)$ is a Lefschetz element for B . This completes the proof of Theorem 4.3.6. □

4.4 Applications To Coinvariant Rings

In this section we focus on the class of 1-skeleta arising from finite reflection groups. Finite reflection groups are well studied objects in mathematics that are very rich in structure. A finite reflection group comes equipped with an action on an ambient vector space. This “geometric representation” of the group gives rise to a larger representation on the polynomial ring, which in turn gives rise to the ring of invariant polynomials and also the coinvariant ring. The coinvariant ring is the object of interest in this section. The main goal is to prove that the coinvariant rings of certain finite reflection groups have the strong Lefschetz property, or, equivalently (as we will show), to show that 1-skeleta arising from these finite reflection groups have the Lefschetz package.

This section is split into two sub-sections. In the first sub-section we give a brief overview of the theory of finite reflection groups (following [18]) and coinvariant rings (following [17] and [3]) together with a description of the 1-skeleton of a finite reflection group (associated to a fixed root system). We will tie these two different points of view together with a concrete isomorphism between the coinvariant ring of W and the cohomology ring of the 1-skeleton of W . In the next sub-section we will prove an analogue of Theorem 4.2.9 in the coinvariant setting. Then using Theorem 4.2.16 we give a new proof of the fact that the coinvariant ring of W has the strong Lefschetz property for several types, including the classical types A, B, C , and D .

4.4.1 Preliminaries

Fix an inner product \langle, \rangle on \mathbb{R}^n . A *reflection* in \mathbb{R}^n is a linear transformation s_γ that sends a vector γ to its negative and fixes the hyperplane orthogonal to γ pointwise. In coordinates, we have

$$s_\gamma(x) = x - \check{\gamma}(x)\gamma$$

for an appropriate co-vector $\check{\gamma} \in (\mathbb{R}^n)^*$; in terms of the inner product we have $\check{\gamma}(x) = 2 \frac{\langle x, \gamma \rangle}{\langle \gamma, \gamma \rangle}$.

Definition 4.4.1. A (reduced) root system is a finite set of vectors $\Phi \subset \mathbb{R}^n$ satisfying

R1. If $\alpha \in \Phi$ then $\mathbb{R}\alpha \cap \Phi = \{\alpha, -\alpha\}$

R2. If $\gamma \in \Phi$ then $s_\gamma(\Phi) = \Phi$.

A set of roots $\Delta \subset \Phi$ is a *simple system* (with elements *simple roots*) if its elements form a basis for $\text{span}_{\mathbb{R}}\{\Phi\} \subseteq \mathbb{R}^n$ and every element $\alpha \in \Phi$ is a linear combination of the simple roots with weights of the same sign. A root system always admits a simple system. The *rank* of Φ is the number of simple roots in a simple system. A simple system determines a set of roots $\Phi^+ \subset \Phi$ called the *positive system* (associated to the simple system) by the condition that $\alpha \in \Phi^+$ if α is a linear combination of the simple roots with positive weights. The set of negative roots $\Phi^- \subset \Phi$ is defined analogously; we have $\Phi = \Phi^+ \sqcup \Phi^-$.

A *finite reflection group* W is a finite group that is generated by reflections. Note that W is a finite subgroup of the orthogonal group on \mathbb{R}^n .

Given a root system $\Phi \subset \mathbb{R}^n$, the finite reflection group W associated to Φ is the group generated by the reflections corresponding to the roots: $W = \langle s_\alpha \mid \alpha \in \Phi \rangle$. Conversely given a finite reflection group W an associated root system $\Phi \subset \mathbb{R}^n$ is the set of unit length generators (and their opposites) of the (-1) -eigenspaces of the reflections in W . More precisely, let $\mathcal{T} \subset W$ be the set of reflections in W . For each reflection $s_\gamma \in \mathcal{T}$, let the line $L_\gamma \subset \mathbb{R}^n$ denote its (-1) -eigenspace and let $v_\gamma \in L_\gamma$ be a unit vector. Then define $\Phi = \{\pm v_\gamma \mid s_\gamma \in \mathcal{T}\}$. In general there are different choices for the length of generators of the L_γ which will give rise to different root systems for the same finite reflection group.

For the remainder of this section, we fix a root system $\Phi \subset \mathbb{R}^n$, and a simple system

and its corresponding positive system $\Delta \subset \Phi^+$. Let W be the finite reflection group associated to Φ . We collect some basic facts that will be needed in the sequel.

Label the simple roots $\Delta = \{\gamma_1, \dots, \gamma_k\}$ and let $s_k \in W$ denote the reflection corresponding to the simple root γ_k . It turns out that the set of reflections $\mathcal{S} = \{s_1, \dots, s_k\} \subset W$ generate W ; these are called the *simple reflections*. Hence every element $w \in W$ has an expression as a *word* in the simple reflections.

Definition 4.4.2. For each $w \in W$ define $\ell(w)$ to be the smallest non-negative integer r such that $w = s_{i_1} \cdots s_{i_r}$. We call the word $s_{i_1} \cdots s_{i_r}$ reduced and we refer to the equality $w = s_{i_1} \cdots s_{i_r}$ as a reduced expression for w . The quantity $\ell(w)$ is called the length of w .

Here are some basic properties of the length function.

Theorem 4.4.3. The length function $\ell: W \rightarrow \mathbb{Z}_{\geq 0}$ has the following properties:

- i. There is a unique element $w_0 \in W$ of maximal length.
- ii. $\ell(u \cdot v) \leq \ell(u) + \ell(v)$ for all $u, v \in W$
- iii. $\ell(w_0 \cdot u^{-1}) + \ell(u) = \ell(w_0)$ for all $u \in W$
- iv. $\ell(u) = |\Phi^+ \cap u^{-1}(\Phi^-)| = |\Phi^+ \cap u(\Phi^-)| = \ell(u^{-1})$ for all $u \in W$
- v. $\ell(s_\alpha \cdot v) \neq \ell(v)$ for all $\alpha \in \Phi^+$ and $v \in W$
- vi. If $\gamma \in \Delta$ then for all $w \in W$ we have $\ell(s_\gamma \cdot w) = \begin{cases} \ell(w) + 1 & \text{if } w^{-1}(\gamma) \in \Phi^+ \\ \ell(w) - 1 & \text{if } w^{-1}(\gamma) \in \Phi^- \end{cases}$

Proof. See [18], pages 12-16. □

The following is a fundamental property of the simple reflections.

Theorem 4.4.4. For $\alpha \in \Delta$, $s_\alpha(\Phi^+ \setminus \{\alpha\}) = \Phi^+ \setminus \{\alpha\}$.

Proof. See [18], Proposition 1.4. □

For elements $w', w \in W$ we will write $w' \xrightarrow{\alpha} w$ to mean that $\alpha \in \Phi^+$, $s_\alpha \cdot w' = w$ and $\ell(s_\alpha \cdot w') = \ell(w') + 1$. In general we have the following useful characterization of pairs $\alpha \in \Phi^+$ and $w \in W$ such that $\ell(s_\alpha \cdot w) > \ell(w)$.

Theorem 4.4.5. *For $\alpha \in \Phi^+$, $\ell(s_\alpha \cdot w) > \ell(w)$ if and only if $w^{-1}(\alpha) \in \Phi^+$.*

Proof. See [18], Proposition 5.7. □

Remark. *There is a natural partial order on the set W called the Bruhat ordering, defined as follows: Set $w \leq w'$ if and only if there exist group elements w_1, \dots, w_N and positive roots β_0, \dots, β_N such that*

$$w \xrightarrow{\beta_0} w_1 \xrightarrow{\beta_1} \dots w_N \xrightarrow{\beta_N} w' .$$

Coinvariant Rings

The action of W on \mathbb{R}^n induces an action of W on $S = \text{Sym}(\mathbb{R}^n)$, the symmetric algebra of \mathbb{R}^n or the polynomial ring on $(\mathbb{R}^n)^*$. The set of polynomials that are invariant under this action form a graded sub-ring $S^W \subset S$ called the *invariant ring* of W . Denote by $I \subset S$ the ideal generated by the invariant polynomials of positive degree: that is $I = (S^W)^+ \cdot S$. The quotient ring S/I is called the *coinvariant ring* of W . It is an interesting and difficult problem to try and understand the ring structure of S/I . This is the starting point of an active area of research known as ‘‘Schubert calculus’’. In their famous paper [3], Bernstein, I. Gel’fand, and S. Gel’fand introduced a set of operators on S that, among other things, give a convenient description of the S^W -module structure on S .

Definition 4.4.6. *For $\gamma \in \Phi$, define the operator $A_\gamma: S \rightarrow S[-1]$ by the formula*

$$A_\gamma(f) = \frac{f - s_\gamma(f)}{\gamma} \tag{4.4.1}$$

Since for $x \in S^1 = \mathbb{R}^n$ we have $s_\gamma(x) = x - \check{\gamma}(x)\gamma$, the quotient $\frac{x - s_\gamma(x)}{\gamma}$ is the real number $\check{\gamma}(x)$. Since S is generated in degree one, it follows that A_γ is well-defined.

Theorem 4.4.7. *The operator A_γ has the following properties:*

- i. $A_\gamma^2 = 0$
- ii. $s_\gamma = 1 - \gamma \cdot A_\gamma$
- iii. $\ker(A_\gamma) = S^{\langle s_\gamma \rangle}$
- iv. $A_\gamma(I) \subset I$

Proof. See [17], Lemma 2.2. □

Given an expression $w = s_{i_1} \cdots s_{i_r}$ (not necessarily reduced) define the operator

$$A_{(i_1, \dots, i_r)} := A_{\gamma_{i_1}} \circ \cdots \circ A_{\gamma_{i_r}} : S \rightarrow S[-r]. \quad (4.4.2)$$

Theorem 4.4.8. ([3])

- i. if $\ell(w) < r$ (i.e. the expression $w = s_{i_1} \cdots s_{i_r}$ is not reduced) then the operator $A_{(i_1, \dots, i_r)}$ is zero.
- ii. if $\ell(w) = r$ (i.e. the expression $w = s_{i_1} \cdots s_{i_r}$ is reduced) then the operator $A_{(i_1, \dots, i_r)}$ depends only on the element w ; it is independent of the reduced expression for w .

Proof. See [3], Theorem 3.4 or [17], Proposition 2.6. □

Define the *BGG-operator* for w , $A_w : S \rightarrow S[-r]$, to be the operator in (4.4.2) with respect to any reduced expression; this is well defined by Theorem 4.4.8.

The following is a useful identity due to Bernstein, I. Gel'fand, and S. Gel'fand. In fact this identity can be used to prove Theorem 4.4.8 in short order; see [3], Lemma 3.5 for more details. See also [17], Theorem 4.1.

Theorem 4.4.9. For each $\chi \in S^1$ and each $w \in W$

$$[w^{-1} \circ A_w, \chi] = \sum_{w' \xrightarrow{\alpha} w} \check{\alpha}(w'(\chi)) \cdot w^{-1} \circ A_{w'}. \quad (4.4.3)$$

Some explanation is in order here: on the LHS of (4.4.3) the element χ is viewed as the operator $\chi: S \rightarrow S[1]$ “multiplication by χ ”. The element $w \in W$ is similarly considered as an operator $w: S \rightarrow S$ defined by its action on S . The symbol $[X, Y]$ then denotes the commutator of two operators X and Y on S . The sum is taken over all $w' \in W$ and $\alpha \in \Phi^+$ such that $w' \xrightarrow{\alpha} w$.

Set $d = |\Phi^+|$. Let $\rho = \frac{1}{2} \sum_{\gamma \in \Phi^+} \gamma \in S^1$.

Lemma 4.4.10. $A_w(\rho^{\ell(w)}) > 0$ for all $w \in W$.

Proof. We use induction on $\ell(w) \geq 0$. The base case is trivial since $A_e(\rho^0) = A_e(1) = 1 > 0$. Now assume the result holds for $u \in W$ with $\ell(u) < k$ and let $w \in W$ be an element of length k . Note that

$$\begin{aligned} A_w(\rho^{\ell(w)}) &= w^{-1} \circ A_w(\rho^{\ell(w)}) \\ &= [w^{-1} \circ A_w, \rho](\rho^{\ell(w)-1}) + \rho \circ (w^{-1} \circ A_w)(\rho^{\ell(w)-1}) \\ &= [w^{-1} \circ A_w, \rho](\rho^{\ell(w)-1}). \end{aligned} \quad (4.4.4)$$

The first equality in (4.4.4) holds since $A_w(\rho^{\ell(w)}) \in \mathbb{R}$ is invariant under the action of W , and the third equality follows from the fact that $A_w(S^{k-1}) = 0$. Thus we apply (4.4.3) to (4.4.4) to obtain the equality

$$A_w(\rho^{\ell(w)}) = \sum_{w' \xrightarrow{\alpha} w} \check{\alpha}(w'(\rho)) \cdot A_{w'}(\rho^{\ell(w')}). \quad (4.4.5)$$

Therefore, by the induction hypothesis, it suffices to show that the quantity $\check{\alpha}(w'(\rho)) > 0$ whenever $\alpha \in \Phi^+$ and $\ell(s_\alpha \cdot w') = \ell(w') + 1$. By Theorem 4.4.5, it suffices to verify that $\check{\beta}(\rho) > 0$ whenever $\beta \in \Phi^+$.

To see this first fix $\alpha \in \Delta$ and consider the vector $s_\alpha(\rho) := \rho - \check{\alpha}(\rho)\alpha$. We can write $s_\alpha(\rho) = s_\alpha(\rho - \frac{1}{2}\alpha) + \frac{1}{2}s_\alpha(\alpha)$. Note that $s_\alpha(\rho - \frac{1}{2}\alpha) = \rho - \frac{1}{2}\alpha$ by Theorem 4.4.4; the point is that $\rho - \frac{1}{2}\alpha = \sum_{\gamma \in \Phi^+ \setminus \{\alpha\}} \gamma$, and s_α is a permutation of the set $\Phi^+ \setminus \{\alpha\}$. Thus we see that $s_\alpha(\rho) = \rho - \alpha = \rho - \check{\alpha}(\rho)\alpha$. This shows that $\check{\alpha}(\rho) = 1$ for all $\alpha \in \Delta$. Since the positive roots are positive linear combinations of the simple roots it follows that $\check{\beta}(\rho) > 0$ for all $\beta \in \Phi^+$. This completes the proof of Lemma 4.4.10. \square

Lemma 4.4.11. *For $u, v \in W$, we have*

$$A_u \circ A_v = \begin{cases} A_{u \cdot v} & \text{if } \ell(u \cdot v) = \ell(u) + \ell(v) \\ 0 & \text{otherwise} \end{cases}$$

Proof. This is an immediate consequence of Theorem 4.4.8. \square

The following is known in the literature as the basis theorem. We will prove it here since we will use the ideas of the proof later. We follow [3] Theorem 3.13 for the most part (although our notation is slightly different). See [17] Theorem 2.7 for a different proof.

Theorem 4.4.12. *The elements $\{A_w(\rho^d) \mid w \in W\}$ are a basis for the free S^W -module S .*

Proof. We first establish the S^W -linear independence of the set $\{A_w(\rho^d) \mid w \in W\}$. Suppose there is a non-trivial dependence relation

$$\sum_{w \in W} c_w A_w(\rho^d) = 0, \quad c_w \in S^W. \quad (4.4.6)$$

Let $v \in W$ be an element of minimal length such that $c_v \neq 0$. Consider the operator $A_{w_0 \cdot v^{-1}}$. By Lemma 4.4.11 we have

$$A_{w_0 \cdot v^{-1}} \circ A_u = \begin{cases} A_{w_0 \cdot v^{-1} \cdot u} & \text{if } \ell(w_0 \cdot v^{-1}) + \ell(u) = \ell(w_0 \cdot v^{-1} \cdot u) \\ 0 & \text{otherwise} \end{cases}$$

By Theorem 4.4.3 $\ell(w_0 \cdot v^{-1}) + \ell(u) = d - \ell(v) + \ell(u) \geq \ell(w_0 \cdot v^{-1} \cdot u)$. Hence if $\ell(u) > \ell(v)$, the inequality is strict, and if $\ell(u) = \ell(v)$ then we must have $\ell(w_0 \cdot v^{-1} \cdot u) = d$ hence $u = v$ (by the uniqueness of the longest word). Thus applying $A_{w_0 \cdot v^{-1}}$ to both sides of (4.4.6) we get

$$c_v A_{w_0}(\rho^d) = 0; \quad (4.4.7)$$

note that $A_{w_0 \cdot v^{-1}} \circ A_u$ may not be zero for $\ell(u) < \ell(v)$, but by our choice of v , the weight c_u will be zero. Since $A_{w_0}(\rho^d) > 0$ by Lemma 4.4.10, (4.4.7) implies that $c_v = 0$ which contradicts our original assumption on c_v . Therefore all the weights c_w in (4.4.6) must be zero and thus the set $\{A_w(\rho^d) \mid w \in W\}$ is S^W -linearly independent.

The argument that $\{A_w(\rho^d) \mid w \in W\}$ generate S is a bit more involved. We will argue by induction on $k \geq 0$ that any element $f \in S^k$ can be expressed as an S^W -linear combination of the $A_w(\rho^d)$'s. The base case is trivial in light of Lemma 4.4.10: this implies in particular that $A_{w_0}(\rho^d) \neq 0$ hence $f \in S^0 = \mathbb{R}$ can be written as $f = \frac{1}{A_{w_0}(\rho^d)} f \cdot A_{w_0}(\rho^d)$. Now assume any element of degree $< k$ can be expressed as an S^W -linear combination of $\{A_w(\rho^d) \mid w \in W\}$ and let $f \in S$ be any homogeneous element of degree k . We will show that f is I -equivalent to an element $\tilde{f} \in \text{span}_{\mathbb{R}}\{A_w(\rho^d) \mid w \in W, \ell(w) = d - k\} \subset S^k$; the induction hypothesis will then finish the argument.

For each $w \in W$ with $\ell(w) = d - k$, define the real number

$$c_w := \frac{A_{w_0 \cdot w^{-1}}(f)}{A_{w_0}(\rho^d)}.$$

Set

$$\tilde{f} := \sum_{\ell(w)=d-k} c_w A_w(\rho^d) \in S^k. \quad (4.4.8)$$

Now apply the operator A_α ($\alpha \in \Delta$) to f and \tilde{f} : On the one hand, by the induction hypothesis we get

$$A_\alpha(f) = \sum_{\ell(u)=d-k+1} c_u^\alpha A_u(\rho^d) + [\text{higher terms}] \quad (4.4.9)$$

where the $c_u^\alpha \in \mathbb{R}$ and the weights of the “higher terms” have degree > 0 . On the other hand we have by (4.4.8) and Lemma 4.4.11

$$A_\alpha(\tilde{f}) = \sum_{w \xrightarrow{\alpha} u} c_w A_u(\rho^d). \quad (4.4.10)$$

We would like to show that for $u \in W$, $\ell(u) = d - k + 1$ we have

$$c_u^\alpha = \begin{cases} c_w & \text{if } w \xrightarrow{\alpha} u \\ 0 & \text{otherwise.} \end{cases} \quad (4.4.11)$$

First suppose that $\ell(s_\alpha \cdot u) > \ell(u)$. Then applying A_α to both sides of (4.4.9) again yields

$$0 = \sum_{\substack{\ell(u)=d-k+1 \\ u \xrightarrow{\alpha} (s_\alpha \cdot u)}} c_u^\alpha A_{s_\alpha \cdot u}(\rho^d) + \text{“other terms”}$$

where the “other terms” are of the form $d_u^\alpha \cdot A_{w'}(\rho^d)$ where $\ell(w') > \ell(s_\alpha \cdot u)$. Hence by the S^W -linear independence of the $A_w(\rho^d)$'s that we just established we see that indeed $c_u^\alpha = 0$.

On the other hand if $\ell(s_\alpha \cdot u) < \ell(u)$ then we must have by Theorem 4.4.3 that $\ell(s_\alpha \cdot u) = \ell(u) - 1$ and hence $w = (s_\alpha \cdot u) \xrightarrow{\alpha} u$. In this case applying the operator $A_{w_0 \cdot u^{-1}}$ to both sides of (4.4.9) yields

$$A_{w_0 \cdot w^{-1}}(f) = c_u^\alpha A_{w_0}(\rho^d) = c_w A_{w_0}(\rho^d), \quad (4.4.12)$$

hence in this case we get $c_u^\alpha = c_w$ as desired (note that the higher terms in (4.4.9) are of the form $d_v^\alpha \cdot A_v(\rho^d)$ where $\ell(v) > d - k + 1$, hence by Lemma 4.4.11, $A_{w_0 \cdot u^{-1}} \circ A_v$ is zero). This shows that (4.4.11) holds.

Combining (4.4.11) with (4.4.9) and (4.4.10), we get $A_\alpha(f) - A_\alpha(\tilde{f}) = [\text{higher terms}] \in I$ and hence that $A_\alpha(f) \equiv A_\alpha(\tilde{f}) \pmod{I}$ for every $\alpha \in \Delta$. This implies that

$$f - \tilde{f} \equiv s_\alpha(f - \tilde{f}) \pmod{I}.$$

Since W is generated by $\{s_\alpha \mid \alpha \in \Delta\}$ it follows that $f - \tilde{f} \equiv w(f - \tilde{f}) \pmod{I}$ for all $w \in W$. Hence

$$f - \tilde{f} \equiv \frac{1}{|W|} \sum_{w \in W} w(f - \tilde{f}) \equiv 0 \pmod{I},$$

hence

$$f \equiv \tilde{f} \pmod{I}.$$

This shows that $\{A_w(\rho^d) \mid w \in W\}$ generate S by induction and hence completes the proof of Theorem 4.4.12. \square

Corollary 4.4.13. *S is a free S^W -module of rank $|W|$ with $\{|w \in W \mid \ell(w) = d - k\}$ generators in degree k .*

We end this part of the discussion with a useful corollary that follows from the proof of Theorem 4.4.12.

Corollary 4.4.14. *For every homogeneous non-zero $f \in S^k$ there is a $w \in W$ such that $0 \neq A_w(f) \in S^W$.*

Proof. Write $f = \sum_{u \in W} c_u A_u(\rho^d)$ for some unique weights $c_u \in S^W$. Let $w \in W$ be an element of minimal length such that $c_w \neq 0$. Then $A_{w_0 \cdot w^{-1}}(f) = c_w A_{w_0}(\rho^d)$ is a non-zero, real multiple of $c_w \in S^W$. \square

1-Skeleta

Define the d -valent graph Γ_W by setting $V_{\Gamma_W} := W$ and

$$E_{\Gamma_W} = \{\overline{xy} \mid y = s_\gamma \cdot x, \gamma \in \Phi^+\}.$$

Define the function

$$\alpha_W: E_{\Gamma_W} \rightarrow \mathbb{R}^n$$

by the formula

$$\alpha(\overline{x(s_\gamma \cdot x)}) = \begin{cases} \gamma & \text{if } x^{-1}(\gamma) > 0 \\ -\gamma & \text{if } x^{-1}(\gamma) < 0 \end{cases}$$

It is straightforward to show that the pair $(\Gamma_W, \alpha_W) \subset \mathbb{R}^n$ is a d -valent 1-skeleton. There is a natural connection on Γ_W compatible with α_W , defined as follows. Fix $e = \overline{x(s_\gamma \cdot x)} \in E_{\Gamma_W}$ and let $e' := \overline{x(s_\beta \cdot x)}$ be any other oriented edge issuing from x . Define

$$\theta_e(e') := \overline{(s_\gamma \cdot x)(s_{s_\gamma(\beta)} \cdot s_\gamma \cdot x)}.$$

We compute

$$\alpha_W(e) = \begin{cases} \gamma & \text{if } x^{-1}(\gamma) > 0 \\ -\gamma & \text{if } x^{-1}(\gamma) < 0 \end{cases} \quad (4.4.13)$$

and

$$\alpha_W(e') = \begin{cases} \beta & \text{if } x^{-1}(\beta) > 0 \\ -\beta & \text{if } x^{-1}(\beta) < 0 \end{cases} \quad (4.4.14)$$

and

$$\alpha_W(\theta_e(e')) = \begin{cases} s_\gamma(\beta) & \text{if } x^{-1}(\gamma) > 0 \\ -s_\gamma(\beta) & \text{if } x^{-1}(\gamma) < 0. \end{cases} \quad (4.4.15)$$

Combining (4.4.14) and (4.4.15) with (4.4.13) we see that

$$\alpha(e') - \alpha(\theta_e(e')) = \pm \check{\gamma}(\beta) \alpha(e). \quad (4.4.16)$$

Thus $\theta_W = \{\theta_e\}_{e \in E_{\Gamma_W}}$ defines a connection for the pair (Γ_W, α_W) , hence we have a 1-skeleton with connection $(\Gamma_W, \alpha_W, \theta_W)$. Furthermore we see from (4.4.16) that the compatibility constants for $(\Gamma_W, \alpha_W, \theta_W)$ are all equal to 1; in other words $(\Gamma_W, \alpha_W, \theta_W)$ is GKM.

It will be useful to fix a polarization of (Γ_W, α_W) . Choose and fix a covector $\xi \in (\mathbb{R}^n)^*$ such that $\langle \xi, \gamma \rangle > 0$ for all $\gamma \in \Delta$ (we can always choose such a covector since the

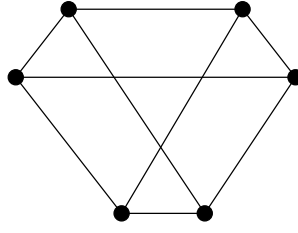

Figure 36. 1-skeleton of S_3

simple roots are linearly independent). Then in particular $\langle \xi, \alpha(e) \rangle \neq 0$ for all $e \in E_{\Gamma_W}$, hence ξ is a generic covector for (Γ_W, α_W) . ξ will be polarizing since (Γ_W, α_W) admits an embedding. To see this just choose any non-zero $a \in \text{span}_{\mathbb{R}}\{\Phi\}$ not belonging to any eigenspace of $w \in W$ (which exists since W is finite). Then define the function $f: V_{\Gamma_W} \rightarrow \mathbb{R}^n$ by $f(w) := w(a)$; this will be the desired embedding.

For any root $\beta \in \Phi$, we have that

$$\langle \xi, \beta \rangle > 0 \Leftrightarrow \beta \in \Phi^+.$$

Fix $x \in V_{\Gamma_W} = W$. Then the neighbors of x in W are those “vertices” of the form $s_\gamma \cdot x$ where $\gamma \in \Phi^+$. Then by our choice of ξ , we have

$$\langle \xi, \alpha(\overline{x(s_\gamma \cdot x)}) \rangle < 0 \Leftrightarrow x^{-1}(\gamma) \in \Phi^+.$$

On the other hand we have $\ell(x) = \ell(x^{-1}) = |\Phi^+ \cap x(\Phi^-)|$ by Theorem 4.4.3. Therefore we have the identity

$$\text{ind}_\xi(x) = \ell(x). \quad (4.4.17)$$

Remark. *In fact, more is true: the partial ordering on V_{Γ_W} induced by ξ coincides with the Bruhat ordering on W .*

Coinvariant Ring vs. Cohomology Ring

Now that we have been formally introduced to the both the coinvariant ring and the 1-skeleton of a finite reflection group, we want to establish a connection between these

two objects. As usual, we will work with the equivariant cohomology ring of (Γ_W, α_W) . There is an “equivariant” coinvariant ring obtained by extending the scalars of the S^W -module S to a (right) S -module $S \otimes_{S^W} S$ (i.e. $s \cdot (f \otimes g) := f \otimes s \cdot g$ for all $s \in S$ and simple tensors $f \otimes g \in S \otimes_{S^W} S$). By Theorem 4.4.12, $S \otimes_{S^W} S$ is a free S -module of rank $|W|$. The BGG-operators A_w (which are S^W -module endomorphisms of S) extend formally to operators $A_w \otimes 1$ (now S -module endomorphisms of $S \otimes_{S^W} S$); we will refer to these extended operators as *equivariant* BGG-operators. There are analogous operators on the equivariant cohomology of (Γ_W, α_W) .

Definition 4.4.15. For each $\gamma \in \Phi$ and for each $F: V_{\Gamma_W} \rightarrow S$ define the map

$$Z_\gamma(F): V_{\Gamma_W} \rightarrow Q(S)$$

by the formula

$$Z_\gamma(F)(x) := \frac{F(x) - F(x \cdot s_\gamma)}{x(\gamma)}$$

where $Q(S)$ is the quotient field of S .

Lemma 4.4.16. If $F \in H(\Gamma_W, \alpha_W)$ then

- i. $Z_\gamma(F)(x) \in S$ for all $x \in W = V_{\Gamma_W}$,
- ii. The function $Z_\gamma(F): V_{\Gamma_W} \rightarrow S$ is an equivariant class.

Proof. To see (i) we observe that for any $\gamma \in \Phi^+$ and any $x \in W$ we have $x \cdot s_\gamma = s_{x(\gamma)} \cdot x$. Hence if $F \in H(\Gamma_W, \alpha_W)$ then $F(x) - F(x \cdot s_\gamma) \in \langle x(\gamma) \rangle$ which implies that $Z_\gamma(F)(x) \in S$.

To see (ii), let $\overline{xy} \in E_{\Gamma_W}$ where $y = s_\beta \cdot x$ for some $\beta \in \Phi^+$. We have

$$Z_\gamma(F)(x) = \frac{F(x) - F(x \cdot s_\gamma)}{x(\gamma)} \tag{4.4.18}$$

$$Z_\gamma(F)(y) = \frac{F(y) - F(y \cdot s_\gamma)}{y(\gamma)} \tag{4.4.19}$$

We want to show that the difference $Z_\gamma(F)(x) - Z_\gamma(F)(y)$ lies in the prime ideal $\langle \beta \rangle \subset S$.

There are two cases to consider:

Case 1: $x(\gamma) \cdot y(\gamma) \in \langle \beta \rangle$. Assume without loss of generality that $x(\gamma) \in \langle \beta \rangle$. Then $x(\gamma) = \pm\beta$, hence $y = s_\beta \cdot x = x \cdot s_{x^{-1}(\beta)} = x \cdot s_\gamma$. Thus in this case we have $Z_\gamma(F)(x) - Z_\gamma(F)(y) = 0 \in \langle \beta \rangle$.

Case 2: $x(\gamma) \cdot y(\gamma) \notin \langle \beta \rangle$. In this case it will suffice to show that the product

$$(x(\gamma) \cdot y(\gamma)) \cdot (Z_\gamma(F)(x) - Z_\gamma(F)(y)) \quad (4.4.20)$$

lies in the (prime) ideal $\langle \beta \rangle$. Expanding (4.4.20) we get

$$\begin{aligned} & (F(x) - F(x \cdot s_\gamma)) \cdot y(\gamma) - (F(y) - F(y \cdot s_\gamma)) \cdot x(\gamma) \\ &= (F(x) - F(x \cdot s_\gamma)) \cdot (x(\gamma) - \check{\beta}(x(\gamma))\beta) - (F(y) - F(y \cdot s_\gamma)) \cdot x(\gamma) \\ &= \left[(F(x) - F(y)) - (F(x \cdot s_\gamma) - F(y \cdot s_\gamma)) \right] \cdot x(\gamma) - (F(x) - F(x \cdot s_\gamma)) \cdot \check{\beta}(x(\gamma))\beta. \end{aligned}$$

Since F is an equivariant class, the first summand in the last equality lies in $\langle \beta \rangle$ and the second is clearly in $\langle \beta \rangle$, hence (4.4.20) lies in $\langle \beta \rangle$. This proves that $Z_\gamma(F)$ is an equivariant class. \square

Thus it makes sense to define the S -module endomorphism $Z_\gamma : H(\Gamma_W, \alpha_W) \rightarrow H(\Gamma_W, \alpha_W)[-1]$.

There is a natural S -algebra homomorphism relating $S \otimes_{S^w} S$ and $H(\Gamma_W, \alpha_W)$:

$$S \otimes_{S^w} S \xrightarrow{\Psi} H(\Gamma_W, \alpha_W) \quad (4.4.21)$$

$$(f \otimes g) \longmapsto \{x \mapsto x(f) \cdot g\}.$$

Lemma 4.4.17. *The following diagram commutes*

$$\begin{array}{ccc} S \otimes_{S^w} S & \xrightarrow{\Psi} & H(\Gamma_W, \alpha_W) \\ A_\gamma \downarrow & & \downarrow Z_\gamma \\ S \otimes_{S^w} S[-1] & \xrightarrow{\Psi} & H(\Gamma_W, \alpha_W)[-1]. \end{array}$$

Proof. It is enough to check that $Z_\gamma \circ \Psi = \Psi \circ A_\gamma$ on the simple tensors in $S \otimes_S S$. We compute:

$$Z_\gamma(\Psi(f \otimes g))(x) = \frac{x(f) \cdot g - x(s_\gamma(f)) \cdot g}{x(\gamma)} = g \cdot \left(\frac{x(f) - x(s_\gamma(f))}{x(\gamma)} \right). \quad (4.4.22)$$

On the other hand

$$\Psi(A_\gamma(f \otimes g))(x) = x \left(\frac{f - s_\gamma(f)}{\gamma} \right) \cdot g. \quad (4.4.23)$$

Comparing (4.4.22) with (4.4.23) gives the desired result. \square

Theorem 4.4.18. *The map Ψ is an S -algebra isomorphism.*

This is a non-trivial fact (although the proof is not difficult) relating two distinct points of view of the same object: On the one hand the description of the equivariant cohomology ring is local in nature; a class is determined by its value at the vertices. On the other hand an element in $S \otimes_S S$ is determined by the invariant theory of W on the polynomial ring S .

Proof of Theorem 4.4.18. The first step is to compare the dimensions of the graded pieces. From Theorem 4.4.12, $S \otimes_S S$ is a free S -module with a basis $\{A_w(\tau) \otimes 1 \mid w \in W\}$. In particular we compute directly that

$$\dim_{\mathbb{R}}((S \otimes_S S)^k) = \sum_{i=0}^k |\{x \in W \mid l(x) = d-k\}| \cdot \dim_{\mathbb{R}}(S^{k-i}) = \sum_{i=0}^k |\{x \in W \mid l(x) = k\}| \cdot \dim_{\mathbb{R}}(S^{k-i}).$$

By (4.4.17) we see that

$$\dim_{\mathbb{R}}((S \otimes_S S)^k) = \sum_{i=0}^k b_i(\Gamma_W, \alpha_W) \cdot \dim_{\mathbb{R}}(S^{k-i}). \quad (4.4.24)$$

On the other hand, recall from the discussion in chapter 3 (see (3.1.3) on page 106) that we always have the inequality

$$\dim_{\mathbb{R}}(H^k(\Gamma_W, \alpha_W)) \leq \sum_{i=0}^k b_i(\Gamma_W, \alpha_W) \cdot \dim_{\mathbb{R}}(S^{k-i}). \quad (4.4.25)$$

Therefore in order to prove Theorem 4.4.18, it suffices to show that Ψ is injective.

Suppose otherwise and let $f \in S \otimes_{S^W} S$ be a non-zero element in the kernel of Ψ . By Corollary 4.4.14 there is a $w \in W$ such that $0 \neq (A_w \otimes 1)(f) \in S^W \otimes_{S^W} S$. Then $\Psi((A_w \otimes 1)(f)): V_{\Gamma_w} \rightarrow S$ is a non-zero constant function. By Lemma 4.4.17 we deduce that $Z_w(\Psi(f))$ is the same non-zero constant function. But this contradicts our choice of $f \in \ker\{\Psi\}$. This shows that Ψ is injective and hence completes the proof of Theorem 4.4.18. \square

Corollary 4.4.19. *The map Ψ induces an isomorphism of graded \mathbb{R} -algebras*

$$\bar{\Psi}: S_W \rightarrow \overline{H(\Gamma_w, \alpha_w)}.$$

Proof. Apply the functor $- \otimes_S \mathbb{R}$ to both sides of (4.4.21). \square

Remark. *An analogue of Theorem 4.4.18 is proved by Guillemin, Holm and Zara in the case where W is a Weyl group, using ideas from equivariant cohomology theory applied to homogeneous spaces. See [12] Theorem 2.6.*

4.4.2 Leray-Hirsch Decomposition

In the interest of self-containment we will proceed without further mention of 1-skeleta or cohomology rings. In this sub-section we establish a result analogous to Theorem 4.2.9. We then use this result to deduce that S_W has the strong Lefschetz property for a certain class of finite reflection group W .

For any subset $\Theta \subset \Delta$ of simple roots, let $\Phi_\Theta \subset \Phi$ denote the subset of roots in the subspace spanned by Θ : $\Phi_\Theta = \Phi \cap \text{span}_{\mathbb{R}}\{\Theta\}$. It is straightforward to show that Φ_Θ is also a root system of rank equal to $|\Theta|$. A simple system for Φ_Θ is Θ and $\Phi_\Theta^+ := \Phi^+ \cap \text{span}_{\mathbb{R}}\{\Theta\}$ is the corresponding positive system. The reflection group W_Θ associated to Φ_Θ is a subgroup of W called the *parabolic subgroup* associated to Θ . W_Θ also acts on \mathbb{R}^n and

thus on S by restricting the action of W . Let S^{W_Θ} denote the invariant ring of W_Θ . Note that the invariant ring of W is naturally a sub-ring of the invariant ring of W_Θ . Let $I_\Theta \subset S$ denote the ideal generated by the positive degree invariants and let $S_{W_\Theta} = S/I_\Theta$ denote the coinvariant ring of W_Θ . Since $I \subseteq I_\Theta$, there is a natural surjection of rings

$$\iota: S_W \rightarrow S_{W_\Theta}$$

induced by the identity map on S .

The action of W on S induces an action on the coinvariant ring, S_W , and hence by restriction, an action by the parabolic sub-group W_Θ . Let $S_W^{W_\Theta}$ denote the sub-ring of W_Θ -invariant coinvariants called the ring of *relative coinvariants* (with respect to $W_\Theta \subset W$). Let

$$\pi: S_W^{W_\Theta} \rightarrow S_W$$

denote the natural inclusion of rings.

We want to understand the relative coinvariants and their relation to the coinvariants. First we give an alternative description that will be useful.

Lemma 4.4.20. *The natural map $i: S^{W_\Theta} \rightarrow S_W^{W_\Theta}$ is surjective and induces an isomorphism $\frac{S^{W_\Theta}}{(S^W)^+ \cdot S^{W_\Theta}} \cong S_W^{W_\Theta}$.*

Proof. To see that i is surjective, take any $f \in S_W^{W_\Theta} \subset S_W$ and let $F \in S$ be any lift. Let $F^\# \in S^{W_\Theta}$ be the average of F over W_Θ . Then $i(F^\#) = f^\# = f$.

Note that $\ker(i) = (S^W)^+ \cdot S \cap S^{W_\Theta} \supseteq (S^W)^+ \cdot S^{W_\Theta}$. The claim is that the containment is actually equality. Indeed let $f \in \ker(i)$; write $f = s_1 g_1 + \dots + s_r g_r$ for some $s_j \in (S^W)^+$ and $g_j \in S$. Averaging over W_Θ we get $f^\# = f = s_1 g_1^\# + \dots + s_r g_r^\# \in (S^W)^+ \cdot S^{W_\Theta}$ which completes the proof. \square

The following result is a version of Theorem 4.2.9 in the language of coinvariant rings.

Theorem 4.4.21. *The coinvariant ring S_W is a free $S_W^{W_\Theta}$ -module of rank $|W_\Theta| = \dim_{\mathbb{R}}(S_{W_\Theta})$.*

Proof. By Corollary 4.4.13, S is a free S^{W_Θ} -module of rank $|W_\Theta| := t$. Therefore there is an isomorphism of S^{W_Θ} -modules

$$\Psi: S \rightarrow \bigoplus_{i=1}^t S^{W_\Theta}. \quad (4.4.26)$$

Apply the functor $-\otimes_{S_W} \mathbb{R}$ to both sides of (4.4.26) to get

$$\Psi \otimes 1: S \otimes_{S_W} \mathbb{R} \rightarrow \left(\bigoplus_{i=1}^t S^{W_\Theta} \right) \otimes_{S_W} \mathbb{R} \cong \bigoplus_{i=1}^t (S^{W_\Theta} \otimes_{S_W} \mathbb{R}).$$

By Lemma 4.4.20 $S_W^{W_\Theta} \cong S^{W_\Theta} \otimes_{S_W} \mathbb{R}$ and this completes the proof of Theorem 4.4.21. \square

Corollary 4.4.22. *The surjection $\iota: S_W \rightarrow S_{W_\Theta}$ has $\ker(\iota) = (S_W^{W_\Theta})^+ \cdot S_W$*

Proof. By Lemma 4.4.20 we have $\ker(\iota) \supseteq (S_W^{W_\Theta})^+ S_W$; we conclude that this containment is an equality by dimension count: On the one hand we have

$$\dim(\ker(\iota)) = \dim(S_W) - \dim(S_{W_\Theta}) = |W| - |W_\Theta|.$$

On the other hand by Theorem 4.4.21 we compute that $\dim(S_W^{W_\Theta}) = |W^\Theta| = \frac{|W|}{|W_\Theta|}$. Therefore, again using Theorem 4.4.21, we compute

$$\dim((S_W^{W_\Theta})^+ \cdot S_W) = (|W^\Theta| - 1)|W_\Theta| = \left(\frac{|W|}{|W_\Theta|} - 1 \right) |W_\Theta|.$$

This shows that $\ker(\iota) = (S_W^{W_\Theta})^+ \cdot S_W$. \square

We now take a closer look at the relative coinvariant ring itself. Let $W^\Theta := \{w \in W \mid l(w \cdot s_\gamma) = l(w) + 1 \ \forall \gamma \in \Theta\}$.

Lemma 4.4.23. *W^Θ is the set of representatives of the cosets W/W_Θ that have minimal length. Furthermore, every element $w \in W$ can be expressed uniquely as $w = \bar{w} \cdot \hat{w}$ where $\bar{w} \in W^\Theta$ and $\hat{w} \in W_\Theta$ and we have $\ell(w) = \ell(\bar{w}) + \ell(\hat{w})$.*

Proof. See [17], Theorem 5.1 and Corollary 5.2. □

Define $\rho_\Theta = \frac{1}{2} \sum_{\gamma \in \Phi_\Theta^+} \gamma$ and $\bar{\rho} = \frac{1}{2} \sum_{\gamma \in \Phi^+ \setminus \Phi_\Theta^+} \gamma$; we have $\rho = \rho_\Theta + \bar{\rho}$. Note that $\bar{\rho} \in S^{W_\Theta}$.

Indeed if $\alpha \in \Theta \subseteq \Delta$ then

$$s_\alpha(\Phi_\Theta^+ \setminus \{\alpha\}) = \Phi_\Theta^+ \setminus \{\alpha\}.$$

But also

$$s_\alpha(\Phi^+ \setminus \{\alpha\}) = \Phi^+ \setminus \{\alpha\}.$$

Therefore we must also have

$$s_\alpha(\Phi^+ \setminus \Phi_\Theta^+) \subseteq \Phi^+ \setminus \Phi_\Theta^+.$$

Since W_Θ is generated by s_α ($\alpha \in \Theta$), we see that W_Θ just permutes the roots in $\Phi^+ \setminus \Phi_\Theta^+$, hence preserves $\bar{\rho}$.

We write $\bar{u} \xrightarrow{\beta} \bar{w}$ to mean that $\beta \in \Phi^+$, $s_\beta \bar{u} = \bar{w}$ and $\ell(s_\beta \cdot \bar{u}) = \ell(\bar{u}) + 1$.

Lemma 4.4.24.

$$A_{\bar{w}}(\bar{\rho}^{\ell(\bar{w})}) = \sum_{\bar{u} \xrightarrow{\beta} \bar{w}} \check{\beta}(\bar{u}(\bar{\rho})) \cdot A_{\bar{u}}(\bar{\rho}^{\ell(\bar{u})}), \quad (4.4.27)$$

where the sum is taken over all $\bar{u} \in W^\Theta$, $\beta \in \Phi^+$ such that $\bar{u} \xrightarrow{\beta} \bar{w}$

Proof. Use the identity in (4.4.5) to get

$$A_{\bar{w}}(\bar{\rho}^{\ell(\bar{w})}) = \sum_{u \xrightarrow{\alpha} \bar{w}} \check{\alpha}(u(\bar{\rho})) \cdot A_u(\bar{\rho}^{\ell(u)}). \quad (4.4.28)$$

For $u \xrightarrow{\alpha} \bar{w}$ write $u = \bar{u} \cdot \hat{u}$ as in Lemma 4.4.23. Then $A_u = A_{\bar{u}} \circ A_{\hat{u}}$. But for $\hat{u} \neq e$, $A_{\hat{u}}(\bar{\rho}^{\ell(u)}) = 0$ since $\bar{\rho}$ is W_Θ -invariant (we are appealing to Theorem 4.4.7 (iii) here). Therefore the only non-zero summands in (4.4.28) are those for which $u = \bar{u}$, hence the assertion of Lemma 4.4.24 follows. □

Remark. A result of Deodhar (see [8], Corollary 3.8) states that given two elements $\bar{w}_1, \bar{w}_2 \in W^\Theta$ with $\bar{w}_1 \leq \bar{w}_2$ (where \leq denotes the Bruhat ordering on W), there exist elements $u_1, \dots, u_r \in W^\Theta$ such that

$$\bar{w}_1 = u_0 \xrightarrow{\beta_0} u_1 \xrightarrow{\beta_1} \dots \quad u_r \xrightarrow{\beta_r} u_{r+1} = \bar{w}_2 .$$

In particular this guarantees that the sum in (4.4.27) is never vacuous.

Lemma 4.4.25. $\check{\alpha}(\bar{\rho}) > 0$ for all $\alpha \in \Phi^+ \setminus \Phi_\Theta^+$.

Proof. First assume that $\alpha \in \Delta \setminus \Theta$. Then $\check{\alpha}(\rho_\Theta) < 0$ since $\langle \alpha, \alpha' \rangle < 0$ for $\alpha' \in \Delta \setminus \{\alpha\}$.

On the other hand we have already seen that $\check{\alpha}(\rho) > 0$, hence we must have $\check{\alpha}(\bar{\rho}) > 0$.

Now let $\alpha \in \Phi^+ \setminus \Phi_\Theta^+$ be arbitrary. There is a unique $\alpha_\Theta \in \text{span}_{\mathbb{R}}\{\Theta\}$ such that

$$\alpha = \sum_{\gamma \in \Delta \setminus \Theta} c_\gamma \cdot \gamma + \alpha_\Theta$$

for some $c_\gamma \geq 0$. Since $\bar{\rho}$ is W_Θ -invariant, we must have $\langle \alpha_\Theta, \bar{\rho} \rangle = 0$. Thus we have that

$$\langle \alpha, \bar{\rho} \rangle = \sum_{\gamma \in \Delta \setminus \Theta} c_\gamma \cdot \langle \gamma, \bar{\rho} \rangle. \quad (4.4.29)$$

Using the formula

$$\check{\alpha}(x) = 2 \frac{\langle \alpha, x \rangle}{\langle \alpha, \alpha \rangle}$$

it follows from the argument above that $\langle \gamma, \bar{\rho} \rangle > 0$ for every $\gamma \in \Delta \setminus \Theta$. Hence (4.4.29)

implies that $\langle \alpha, \bar{\rho} \rangle > 0$ and therefore that $\check{\alpha}(\bar{\rho}) > 0$ for all $\alpha \in \Phi^+ \setminus \Phi_\Theta^+$ as desired. □

Lemma 4.4.26.

$$A_{\bar{w}}(\bar{\rho}^{\ell(\bar{w})}) > 0. \quad (4.4.30)$$

Proof. By (4.4.27) in Lemma 4.4.24 it suffices to show by induction that $\check{\beta}(\bar{u}(\bar{\rho})) > 0$ for $\bar{u} \xrightarrow{\beta} \bar{w}$. By Theorem 4.4.5 $\bar{u} \xrightarrow{\beta} \bar{w}$ implies that $\bar{u}^{-1}(\beta) \in \Phi^+ \setminus \Phi_\Theta^+$. Indeed Theorem

4.4.5 certainly guarantees that $\bar{u}^{-1}(\beta) \in \Phi^+$. Since $s_\beta \cdot \bar{u} = \bar{w} = \bar{u} \cdot s_{\bar{u}^{-1}(\beta)} \in W^\Theta$, the root $\bar{u}^{-1}(\beta)$ must not belong to Φ_Θ^+ .

By Lemma 4.4.25 we know that $\check{\alpha}(\bar{\rho}) > 0$ for all $\alpha \in \Phi^+ \setminus \Phi_\Theta^+$. We have

$$\check{\beta}(\bar{u}(\bar{\rho})) = \frac{\langle \beta, \bar{u}(\bar{\rho}) \rangle}{\langle \beta, \beta \rangle} = \frac{\langle \bar{u}^{-1}(\beta), \bar{\rho} \rangle}{\langle \bar{u}^{-1}(\beta), \bar{u}^{-1}(\beta) \rangle} = \check{\alpha}(\bar{\rho}),$$

where we set $\alpha := \bar{u}^{-1}(\beta) \in \Phi^+ \setminus \Phi_\Theta^+$. Hence $\check{\beta}(\bar{u}(\bar{\rho})) > 0$ as desired. \square

Let us pause for a moment to take stock of what we have. Given any parabolic subgroup $W_\Theta \subseteq W$, there is a natural inclusion

$$\pi: S_W^{W_\Theta} \rightarrow S_W$$

with respect to which S_W is a free $S_W^{W_\Theta}$ -module. There is a natural surjective ring homomorphism

$$\iota: S_W \rightarrow S_{W_\Theta}$$

whose kernel is the ideal $(S_W^{W_\Theta})^+ \cdot S_W$. Thus if we knew that S_{W_Θ} and $S_W^{W_\Theta}$ both had the strong Lefschetz property, then we could deduce by Theorem 4.2.16 that S_W also has the Lefschetz property. Before we give the main result, we need a bit more terminology.

Let $R = \bigoplus_{i=0}^d R^i$ be an \mathbb{N} -graded Artinian \mathbb{R} -algebra. If $r_i := \dim_{\mathbb{R}}(R^i)$ then define $g_i = r_i - r_{i-1}$ for $1 \leq i \leq \lfloor \frac{d}{2} \rfloor$. Define the *g-vector* of R to be the tuple $g(R) := (g_1, \dots, g_{\lfloor \frac{d-1}{2} \rfloor})$. If R has the strong Lefschetz property, the entries of the *g-vector* are the dimensions of the positive graded pieces of the primitive subspace with respect to any given Lefschetz element. For instance in the special case that $g(R)$ is the zero vector, R has the strong Lefschetz property if and only if there is an element $l \in R^1$ such that $l^d \neq 0$; in this case the primitive subspace only exists in degree 0. In the literature the *g-vector* of a graded ring $R = \bigoplus_{i=0}^d R^i$ is usually taken to be the tuple $(g_0, g_1, \dots, g_{\lfloor \frac{d}{2} \rfloor})$, where $g_0 := 1$; here we just “cut off” the terms that we do not need.

Define the *rank* of W to be the rank of its associated root system Φ .

Definition 4.4.27. A finite reflection group W of rank N acting on $S(\mathbb{R}^n) = S$ is called tight if there exists a chain of parabolic sub-groups

$$\{e\} \subseteq W_1 \subseteq \cdots \subseteq W_N = W$$

such that

- i. The rank of W_i is i
- ii. $g(S_{W_{i+1}}^{W_i})$ is the zero vector.

The main result is this:

Theorem 4.4.28. If W is tight then S^W has the strong Lefschetz property.

Proof. The proof is by induction on the $rk(W) \geq 1$.

For $rk(W) = 1$ we have $W = \{s_\gamma, e\}$ for some $\gamma \in \mathbb{R}^n$. Then if we choose a basis x_1, \dots, x_{n-1} for the orthogonal complement of γ , we can write

$$S = \mathbb{R}[x_1, \dots, x_{n-1}, \gamma]$$

and

$$S^W = \mathbb{R}[x_1, \dots, x_{n-1}, \gamma^2].$$

Therefore we see that

$$S_W = \frac{\mathbb{R}[x_1, \dots, x_{n-1}, \gamma]}{(x_1, \dots, x_{n-1}, \gamma^2)} \cong \frac{\mathbb{R}[\gamma]}{\gamma^2} \cong P(2)$$

hence S_W has the strong Lefschetz property.

Now assume the assertion holds for tight reflection groups of rank $(k-1)$, and let W be a tight reflection group of rank k . Since W is tight, there is a parabolic subgroup $W' \subset W$ that is also a tight reflection group of rank $(k-1)$. Let $\overline{W} \subset W$ be the set of minimal coset representatives of W/W' and let $r = \ell(\overline{w}_0)$, the length of the longest element of \overline{W} . By

Lemma 4.4.26 we know that $A_{\bar{w}_0}(\bar{\rho}^r) \neq 0$, hence in particular $\bar{\rho}^r \in S^{W'}$ is not in the ideal $(S^W)^+ \cdot S^{W'}$; thus Lemma 4.4.20 implies that its equivalence class $[\bar{\rho}]^r \in S_W^{W'}$ is non-zero. Since $g(S_W^{W'})$ is the zero vector, we conclude that $S_W^{W'}$ has the strong Lefschetz property, with Lefschetz element given by $[\rho] \in (S_W^{W'})^1$. By the induction hypothesis, $S_{W'}$ has the strong Lefschetz property. Hence by Theorem 4.2.16 (with $B = S_W^{W'}$, $F = S_{W'}$ and $E = S_W$) S_W also has the strong Lefschetz property. Thus by induction, S_W has the strong Lefschetz property for all tight finite reflection groups W . This completes the proof of Theorem 4.4.28. \square

Theorem 4.4.29. *A finite reflection group is tight if and only if it is of type $A_N, B_N \cong C_N, D_N, I_2(m)$ or H_3 as well as the rank 1 type that we call J_1 .*

Proof. This can be checked directly using the fundamental weights of a finite reflection group (see the table on page 59 in [18]) and the factorization of the Poincaré polynomial of the relative coinvariant ring (see Cor. 4.5 on page 154 of [17]). \square

4.5 Concluding Remarks

The main question underlying this chapter is the following:

Question. *Which 1-skeleta have the Lefschetz package?*

This question may not be tractable. While we have many examples of 1-skeleta that have the Lefschetz package, the only examples we have at present of 1-skeleta that do not have the Lefschetz package are those whose Betti numbers are not symmetric.

Problem. *Find an example of a 1-skeleton with symmetric Betti numbers that does not have the Lefschetz package.*

In answering the above question it may be helpful to restrict the class of 1-skeleta. For instance one can specialize the question as follows:

Question. *Which 3-independent non-cyclic 1-skeleta have the Lefschetz package?*

In this case, the classification result of Guillemin and Zara tells us that the Betti numbers are symmetric. Using the techniques of cutting and reduction as in chapter 2, one realizes every such 1-skeleton as a cross-section of some larger 1-skeleton. This implies that such a 1-skeleton is gotten from a very simple 1-skeleton by a finite sequence of blow-ups and blow-downs. This would seem to be a viable strategy for answering this specialized question in light of Theorem 4.3.6. We are only missing the converse:

Conjecture 2. *If $(\Gamma^\#, \alpha^\#, \theta^\#)$ has the Lefschetz package, then (Γ, α, θ) also has the Lefschetz package.*

The deformation arguments used in the proof of Theorem 4.3.6 do not directly apply to Conjecture 2. It would seem that one needs a new idea here.

Regarding coinvariant rings of finite reflection groups and Theorems 4.4.28 and 4.2.17, a natural question to ask is:

Question. *Can these methods be used to extend the results of Theorem 4.4.28 to other types of finite reflection groups?*

There are only five types that are not tight as in Definition 4.4.27: E_6, E_7, E_8, F_4 and H_4 . Of these the first four are crystallographic, hence in these cases, that S_W has the strong Lefschetz property follows from Theorem 4.1.1. So in some sense H_4 is the most interesting case. It was shown in 2007 by Numata and Wachi in [24] that S_W has the strong Lefschetz property for W of type H_4 . Their proof is essentially a computation using the computer-algebra tool Macaulay2. We therefore feel that there is still room for a more conceptual proof of this fact and Theorem 4.2.16 may provide one way to

do this. For W of type H_4 , there is a parabolic subgroup $W' \subseteq W$ of type H_3 . Theorem 4.4.29 implies that $S_{W'}$ has the strong Lefschetz property, hence by Theorem 4.2.16 it suffices to show that $S_W^{W'}$ has the strong Lefschetz property. We compute the Poincare polynomial for $S_W^{W'}$ to give the reader an idea of the task at hand:

$$\begin{aligned}
P(W, W') &= \frac{\frac{(t^2-1)(t^{12}-1)(t^{20}-1)(t^{30}-1)}{(t-1)^4}}{\frac{(t^2-1)(t^6-1)(t^{10}-1)}{(t-1)^3}} = (t^{29} + t^{28} + \dots + t + 1)(t^{16} + t^{10} + t^6 + 1) \\
&= t^{45} + \dots + t^{40} + 2t^{39} + \dots + 2t^{36} + \\
&\quad 3t^{35} + \dots + 3t^{30} + 4t^{29} + \dots + 4t^{16} + 3t^{15} + \dots + 3t^{10} + \quad (4.5.1) \\
&\quad 2t^9 + \dots + 2t^6 + t^5 + \dots + t + 1.
\end{aligned}$$

Hence the g -vector consists of three 1's and ten 0's. This indicates that there are three *additional* primitive elements to be found in $S_W^{W'}$ besides the natural primitive element in degree zero.

The cases F_4 and E_6 are a little more promising in that we need only find one additional primitive element. The case E_7 is a little worse with two additional primitive elements to find and E_8 is the worst with seven(!).

BIBLIOGRAPHY

- [1] Michèle Audin. *The topology of torus actions on symplectic manifolds*, volume 93 of *Progress in Mathematics*. Birkhäuser Verlag, Basel, 1991. Translated from the French by the author.
- [2] Gottfried Barthel, Ludger Kaup, J.-P. Brasselet, and Karl-Heinz Fieseler. Hodge-Riemann relations for polytopes: a geometric approach. In *Singularity theory*, pages 379–410. World Sci. Publ., Hackensack, NJ, 2007.
- [3] I. N. Bernšteĭn, I. M. Gelfand, and S. I. Gelfand. Schubert cells, and the cohomology of the spaces G/P . *Uspehi Mat. Nauk*, 28(3(171)):3–26, 1973.
- [4] Raoul Bott and Loring W. Tu. *Differential forms in algebraic topology*, volume 82 of *Graduate Texts in Mathematics*. Springer-Verlag, New York, 1982.
- [5] Theodore Chang and Tor Skjelbred. The topological Schur lemma and related results. *Ann. of Math. (2)*, 100:307–321, 1974.
- [6] Henry Crapo and Walter Whiteley. Autocontraintes planes et polyèdres projetés. I. Le motif de base. *Structural Topology*, (20):55–78, 1993. Dual French-English text.
- [7] Thomas Delzant. Hamiltoniens périodiques et images convexes de l’application moment. *Bull. Soc. Math. France*, 116(3):315–339, 1988.
- [8] Vinay V. Deodhar. Some characterizations of Bruhat ordering on a Coxeter group and determination of the relative Möbius function. *Invent. Math.*, 39(2):187–198, 1977.
- [9] William Fulton. *Introduction to toric varieties*, volume 131 of *Annals of Mathematics Studies*. Princeton University Press, Princeton, NJ, 1993. The William H. Roever Lectures in Geometry.
- [10] Mark Goresky, Robert Kottwitz, and Robert MacPherson. Equivariant cohomology, Koszul duality, and the localization theorem. *Invent. Math.*, 131(1):25–83, 1998.
- [11] Branko Grünbaum. *Convex polytopes*, volume 221 of *Graduate Texts in Mathematics*. Springer-Verlag, New York, second edition, 2003. Prepared and with a preface by Volker Kaibel, Victor Klee and Günter M. Ziegler.

- [12] V. Guillemin, T. Holm, and C. Zara. A GKM description of the equivariant cohomology ring of a homogeneous space. *J. Algebraic Combin.*, 23(1):21–41, 2006.
- [13] V. Guillemin and C. Zara. Equivariant de Rham theory and graphs. *Asian J. Math.*, 3(1):49–76, 1999. Sir Michael Atiyah: a great mathematician of the twentieth century.
- [14] V. Guillemin and C. Zara. 1-skeleta, Betti numbers, and equivariant cohomology. *Duke Math. J.*, 107(2):283–349, 2001.
- [15] Victor Guillemin. *Moment maps and combinatorial invariants of Hamiltonian T^n -spaces*, volume 122 of *Progress in Mathematics*. Birkhäuser Boston Inc., Boston, MA, 1994.
- [16] Victor Guillemin and Catalin Zara. The existence of generating families for the cohomology ring of a graph. *Adv. Math.*, 174(1):115–153, 2003.
- [17] Howard L. Hiller. Schubert calculus of a Coxeter group. *Enseign. Math. (2)*, 27(1-2):57–84, 1981.
- [18] James E. Humphreys. *Reflection groups and Coxeter groups*, volume 29 of *Cambridge Studies in Advanced Mathematics*. Cambridge University Press, Cambridge, 1990.
- [19] Katsuo Kawakubo. *The theory of transformation groups*. The Clarendon Press Oxford University Press, New York, Japanese edition, 1991.
- [20] A. A. Klyachko. Equivariant bundles over toric varieties. *Izv. Akad. Nauk SSSR Ser. Mat.*, 53(5):1001–1039, 1135, 1989.
- [21] Dusa McDuff and Dietmar Salamon. *Introduction to symplectic topology*. Oxford Mathematical Monographs. The Clarendon Press Oxford University Press, New York, second edition, 1998.
- [22] Peter McMullen. On simple polytopes. *Invent. Math.*, 113(2):419–444, 1993.
- [23] William Messing. Short sketch of Deligne’s proof of the hard Lefschetz theorem. In *Algebraic geometry (Proc. Sympos. Pure Math., Vol. 29, Humboldt State Univ., Arcata, Calif., 1974)*, pages 563–580. Amer. Math. Soc., Providence, R.I., 1975.
- [24] Yasuhide Numata and Akihito Wachi. The strong Lefschetz property of the coinvariant ring of the Coxeter group of type H_4 . *J. Algebra*, 318(2):1032–1038, 2007.
- [25] Christian Okonek, Michael Schneider, and Heinz Spindler. *Vector bundles on complex projective spaces*, volume 3 of *Progress in Mathematics*. Birkhäuser Boston, Mass., 1980.

- [26] Richard P. Stanley. The number of faces of a simplicial convex polytope. *Adv. in Math.*, 35(3):236–238, 1980.
- [27] V. A. Timorin. An analogue of the Hodge-Riemann relations for simple convex polyhedra. *Uspekhi Mat. Nauk*, 54(2(326)):113–162, 1999.
- [28] Catalin Zara Victor Guillemin, Silvia Sabatini. Cohomology of gkm fiber bundles. [arXiv:0806.3539](https://arxiv.org/abs/0806.3539).
- [29] Günter M. Ziegler. *Lectures on polytopes*, volume 152 of *Graduate Texts in Mathematics*. Springer-Verlag, New York, 1995.