



University of
Massachusetts
Amherst

Efficient Striping Techniques for Variable Bit Rate Continuous Media File Servers

Item Type	article;article
Authors	Shenoy, Prashant J.
Download date	2024-08-15 07:08:12
Link to Item	https://hdl.handle.net/20.500.14394/9866

Efficient Striping Techniques for Variable Bit Rate Continuous Media File Servers *

Prashant J. Shenoy

Department of Computer Science,
University of Massachusetts at Amherst
Amherst, MA 01003
shenoy@cs.umass.edu

Harrick M. Vin

Department of Computer Sciences,
University of Texas at Austin
Austin, TX 78712
vin@cs.utexas.edu

Abstract

The performance of striped disk arrays is governed by two parameters: the stripe unit size and the degree of striping. In this paper, we describe techniques for determining the stripe unit size and degree of striping for disk arrays storing variable bit rate continuous media data. We present an analytical model that uses the server configuration and the workload characteristics to predict the load on the most heavily loaded disk in redundant and non-redundant arrays. We then use the model to determine the optimal stripe unit size for different workloads. We also use the model to study the effect of various system parameters on the optimal stripe unit size. To determine the degree of striping, we first demonstrate that striping a continuous media stream across all disks in the array causes the number of clients supported to increase sub-linearly with increase in the number of disks. To maximize the number of clients supported in large arrays, we propose a technique that partitions a disk array and stripes each media stream across a single partition. Since load imbalance can occur in such partitioned arrays, we present an analytical model to compute the imbalance across partitions in the array. We then use the model to determine a partition size that minimizes the load imbalance, and hence, maximizes the number of clients supported by the array.

Keywords: Continuous media file servers, striping techniques, disk arrays

1 Introduction

1.1 Motivation

Advances in computing and communication technologies over the past few years have triggered the development of a wide range of information services (e.g., electronic newspapers, distance learning and self-paced education, video mail, etc.). All of these services involve storing, accessing, and processing multiple types of information (e.g., text, audio, video, imagery, etc., - which we collectively refer to as *multimedia*). Realizing such services will require the development of file servers that can efficiently handle multiple data types. To do so, such file servers will be required to employ efficient placement techniques.

To help formulate the problem of efficient placement, let us first introduce some terminology. Digitization of audio yields a sequence of samples and that of video yields a sequence of frames. A continuously recorded sequence of audio samples or video frames is referred to as a *media stream*. Due to the large storage and bandwidth requirements

*A preliminary version of this paper appeared in the Proceedings of the Seventh IEEE International Workshop on Network and Operating System Support for Digital Audio and Video (NOSSDAV'97), pages 25—36, St. Louis, MO, May 1997.

of such media streams, multimedia file servers are generally founded on *disk arrays*. To efficiently utilize a disk array, such servers stripe (i.e., interleave) media streams across disks in the array. A striping policy is governed by two parameters: the *stripe unit size*, which denotes the maximum amount of logically contiguous data stored on a single disk; and the *degree of striping*, which refers to the number of disks across which a particular media stream is striped.

Recently, techniques for determining the stripe unit size and the degree of striping for workloads consisting of textual and numeric data accesses have been proposed [3, 5, 14]. However, these techniques are not directly applicable to file servers optimized for storing audio or video (referred to as *continuous media*) due to the following fundamental characteristics:

- *Real-time requirements of continuous media*: Textual and numeric data accesses require good response times but no absolute performance guarantees. In contrast, due to its real-time nature, continuous media accesses require the file server to provide bounds on response times. Hence, a stripe unit size that minimizes the average response time is considered optimal for textual and numeric data [3], while a stripe unit size that minimizes the tail of the response time distribution (possibly at the expense of an increased average response time) is more desirable for continuous media data.

This fundamental difference in the optimization criterion has a significant impact on the selection of stripe unit size. To illustrate, consider Figure 1(a), which depicts the histogram of the response time observed for two different stripe unit sizes (obtained using a workload of 60 video clients accessing an array of 16 disks). It shows that stripe unit sizes of 32KB and 64KB yield average response times of 30ms and 32ms, respectively. The figure also shows that the histogram for the 32KB stripe unit size has a longer tail. If data accesses do not impose any real-time constraints, 32KB would be chosen as the appropriate stripe unit size. For accesses with real-time constraints, a stripe unit size of 64KB would be more desirable. As shown in Figure 1(b), the block size that minimizes the average response time continues to differ from one that minimizes the 99th percentile of the response time (i.e., the tail of the histogram) across a wide range of client workloads.

- *Periodic and sequential nature of continuous media*: In general, textual and numeric data accesses consist of aperiodic reads and writes, while continuous media workloads consist of reads and writes that are periodic and sequential. Moreover, continuous media applications have a significantly larger data rate requirement as compared to textual applications. These differences in workload characteristics affect the optimal stripe unit size.

Due to the periodic and sequential nature of continuous media, most multimedia file servers employ a *server-push* architecture to service continuous media requests. Such servers service clients by periodically accessing and transmitting data without an explicit request for each access (in contrast to a *client-pull architecture* employed by conventional file servers that access data only in response to explicit client requests). The workload seen by disks in a server-push architecture is markedly different from those seen by disks in a client-pull architecture. Due to these differences, techniques developed for conventional client-pull based servers are inapplicable to server-push based servers.

Due to these differences, novel techniques that optimize the performance of a multimedia file server for continuous media data must be developed.

1.2 Research Contributions of This Paper

In this paper, we propose techniques for determining the stripe unit size and the degree of striping for file servers storing variable bit rate continuous media data. We consider a file server that services clients by proceeding in terms of periodic rounds and argue that, in such environments, a stripe unit size that minimizes the service time (i.e., the total time spent in retrieving the data requested in a round) of the most heavily loaded disk is optimal. To determine the optimal stripe unit size, we develop an analytical model that uses the server configuration and a distribution of

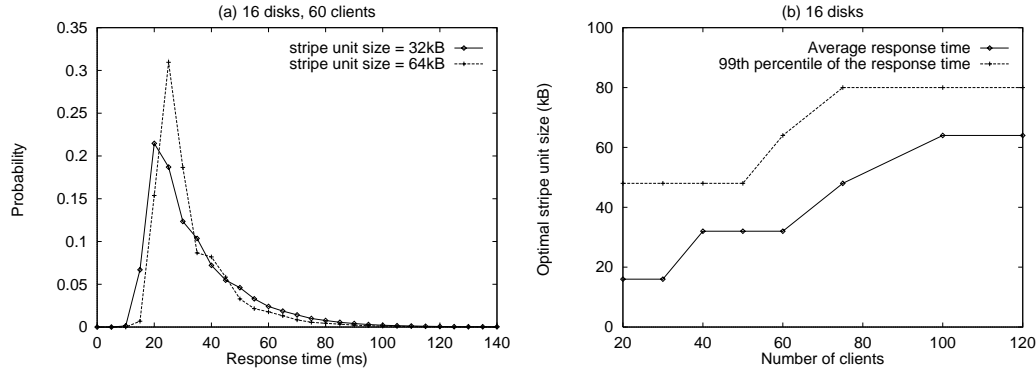

Figure 1: Effect of different metrics on the stripe unit size.

the number of blocks accessed by a client in a round to predict the service time of the most heavily loaded disk in both redundant and non-redundant arrays. By determining the service time of the most heavily loaded disk across a range of block sizes, a stripe unit size that minimizes the service time can be chosen. We validate the accuracy of our model through extensive trace-driven simulations. We demonstrate that, contrary to conventional wisdom, a large stripe unit size does not necessarily yield good server performance. Instead, such a stripe unit size can adversely affect the quality of service guarantees provided to clients, thereby reducing the number of clients supported by the server. We also use the model to: (1) evaluate the effect of various system parameters (such as the number of clients, number of disks, etc.) on the stripe unit size, and (2) derive techniques for selecting an optimal stripe unit size for various design scenarios.

We then use the model to determine the optimal degree of striping for variable bit rate media streams. We demonstrate that striping a media stream across the entire array causes the number of clients supported to increase sub-linearly with increase in number of disks. To maximize the number of clients supported in large arrays, we propose a technique that partitions a disk array and stripes each media stream across a single partition. Since load imbalances can occur in such partitioned arrays, we present a model to compute the imbalance across partitions. We then use the model to determine a partition size that minimizes the load imbalance, and hence, maximizes the number of clients supported by the array.

The rest of this paper is organized as follows. In Section 2, we address the issue of determining an optimal stripe unit size. Section 3 describes techniques for determining the degree of striping. Section 4 describes related work, and finally, Section 5 summarizes our results.

2 Determining the Stripe Unit Size

Consider a multimedia server that interleaves media streams across disks by storing successive blocks of a stream on consecutive disks in a round-robin manner. The unit of interleaving, referred to as a *media block* or a *stripe unit*, denotes the maximum amount of logically contiguous data stored on a single disk.¹ Due to the periodic nature of media playback, the server services multiple clients by proceeding in periodic *rounds*. During each round, the server retrieves a fixed number of *media units* (e.g., video frames or audio samples) for each client. To ensure continuous playback, the number of media units accessed for a client must be sufficient to sustain its playback rate, and the service time (i.e., the total time spent in retrieving media units during a round) must not exceed the duration of a round.

If each media stream is compressed using a variable bit rate (VBR) compression algorithm, then the sizes of successive media units within a stream will vary. Although each client accesses a fixed number of media units in each round, due to variable media unit sizes, the number of blocks requested by the client can *vary from one round*

¹We shall use the terms media block and stripe unit interchangeably in this paper.

to another. The server can service such clients either by retrieving a variable number of blocks across rounds, or by retrieving a fixed number of blocks across rounds and employing prefetching and buffering schemes to smooth out the variations. Depending on the amount of variation in the stream bit rate, the latter approach can substantially increase the initiation latency (since sufficient amount of data must be prefetched before the client can initiate playback). Our experiments with MPEG-1 video clients indicate that, for a round duration of 1s, accessing data at the average bit rate can cause the initiation latency to be more than 20s.² In contrast, since no smoothing is performed when a variable number of blocks are accessed, the clients can initiate playback without any delay. However, accessing a variable number of blocks can cause load imbalances across disks in the array and can reduce the number of clients supported by the server. A key challenge is to devise striping techniques that reduce the load imbalance so as to maximize the number of clients supported. In this paper, we assume that the server services clients by accessing a variable number of blocks across rounds, and determine the stripe unit size and the degree of striping that achieves this objective.

In servers that access a variable number of blocks, the set of disks accessed by different clients during a round are different, and hence, the total number of blocks accessed can vary from one disk to another. Since some disks are more heavily loaded than others, the service time of some of these disks may occasionally exceed the round duration, causing playback discontinuities at client sites. To minimize the frequency of such playback discontinuities, the server must minimize the service time of the most heavily loaded disk in the array. The service time of the most heavily loaded disk depends on the media block size. To observe this, consider a small media block size. Such a block size increases the number of blocks accessed from the array during a round, thereby distributing the load across disks and reducing the load imbalance. However, it also increases the overhead due to seek and rotational latency, thereby increasing the service time of the most heavily loaded disk. In contrast, a large block size reduces the overhead of seek and rotational latency, but increases the load imbalance, and hence, the service time of the most heavily loaded disk. The server must select a media block size that balances these tradeoffs and *minimizes the service time of the most heavily loaded disk in the array*.

In what follows, we present an analytical model that uses the characteristics of the workload and the configuration of the server to predict the service time of the most heavily loaded disk in non-redundant and redundant disk arrays. By computing the service time of the most heavily loaded disk across a range of block sizes, a media block size that minimizes the service time can be chosen.

2.1 Analytical Models for Determining the Load on the Array

2.1.1 A Model for Non-redundant Arrays

Consider a multimedia server that interleaves media streams across a disk array. Given the configuration of the server (e.g., number of disks, their physical characteristics, the round duration, etc.) and the client characteristics (e.g., number of clients, trace of the media unit sizes for each client, playback rate, etc.), the service time of the most heavily loaded disk in redundant and non-redundant disk arrays can be computed as follows:

1. Compute the distribution of the number of blocks accessed from a disk by each client during a round using a trace of media unit sizes.
2. Compute the distribution of the total number of blocks accessed from a disk by summing the number of blocks requested by each client from that disk.
3. Compute the distribution of the number of blocks accessed from the most heavily loaded disk.

²The latency is smaller if the client retrieves the file as a piecewise constant bit rate (CBR) stream [18], rather than a pure CBR stream. However, piecewise CBR retrievals result in a variable load on disks, since bit-rate of clients changes over time and different clients retrieve data at different rates at any instant. Our models are valid for VBR as well as smoothed piecewise CBR retrievals.

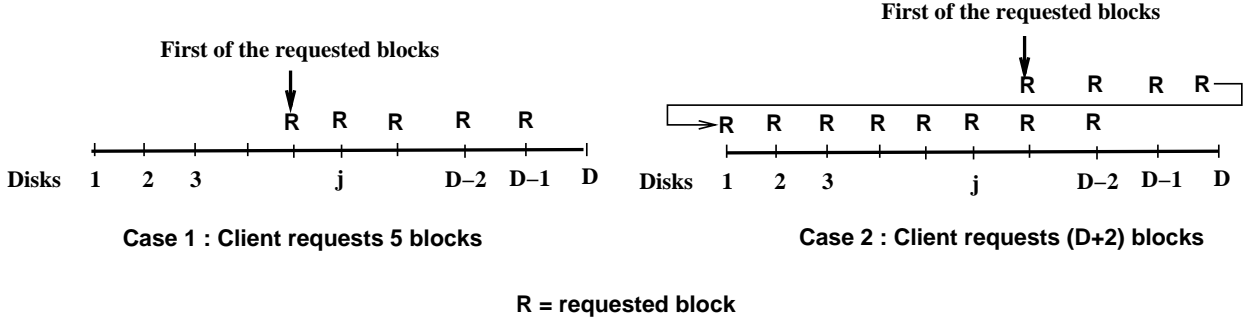

Figure 2: Different scenarios in which client i accesses a block from disk j .

4. Given the distribution of the number of blocks accessed from the most heavily loaded disk, compute the service time distribution for the disk using a disk model.

To derive the model for non-redundant arrays, consider a server that interleaves media streams across an array of D disks. Let n clients access the server, each retrieving a media stream,³ and let B denote the media block size. Since the server accesses a fixed number of media units for each client during a round, the distribution of the number of blocks accessed by the client during a round can be determined from a trace of the media unit sizes. Let b_i^k , obtained from this distribution, denote the probability that client i accesses k blocks from the array in a round, and let p_{ij}^k denote the probability that client i accesses k blocks from disk j in a round. To compute p_{ij}^1 , observe that client i will access exactly one block from disk j in a round if: (1) it requests m blocks ($1 \leq m \leq D$) from the array and the first of these blocks is stored either on disk j or any of the previous $m - 1$ disks; or (2) it requests $D + m$ blocks ($1 \leq m < D$) from the array and the first of these blocks is stored any disk *other than* disk j or any of the previous $m - 1$ disks. Figure 2 illustrates these cases. Due to the VBR nature of media streams, the number of blocks accessed by a client varies from one round to another. Hence, after a small number of rounds, the first block is equally likely to be accessed from any of the disks in the array. Consequently,

$$p_{ij}^1 = \sum_{m=1}^D b_i^m \cdot \frac{m}{D} + \sum_{m=1}^{D-1} b_i^{D+m} \cdot \frac{D-m}{D} \quad (1)$$

Generalizing, client i will access k blocks ($k = 1, 2, 3, \dots$) from disk j if: (1) it requests $(k - 1) \cdot D + m$ blocks ($1 \leq m \leq D$) from the array and the first of these blocks is stored on disk j or any of the previous $m - 1$ disks; or (2) it requests $k \cdot D + m$ blocks ($1 \leq m < D$) from the array and the first of these blocks is stored on any disk other than disk j or any of the previous $m - 1$ disks. Hence,

$$p_{ij}^k = \sum_{m=1}^D b_i^{(k-1) \cdot D + m} \cdot \frac{m}{D} + \sum_{m=1}^{D-1} b_i^{k \cdot D + m} \cdot \frac{D-m}{D} \quad (2)$$

Lastly, the probability that client i does not access disk j is $p_{ij}^0 = 1 - \sum_{k=1}^{\infty} p_{ij}^k$.

Let \mathcal{X}_{ij} be a random variable denoting the number of blocks accessed by client i from disk j during a round. Then,

$$P(\mathcal{X}_{ij} = k) = p_{ij}^k \quad (3)$$

Then, the total number of blocks accessed from disk j during a round, \mathcal{N}_j , can be computed as

$$\mathcal{N}_j = \sum_{i=1}^n \mathcal{X}_{ij} \quad (4)$$

³Since continuous media requests are dominated by read requests, we confine our focus to read requests.

Due to the VBR nature of video streams, the number of blocks accessed by clients from the array are independent of each other. Thus, $\mathcal{X}_{1j}, \mathcal{X}_{2j}, \dots, \mathcal{X}_{nj}$ are independent random variables, and hence, the distribution of \mathcal{N}_j can be obtained by applying the the z-transform ⁴ to (4). That is,

$$Z(\mathcal{N}_j) = \prod_{i=1}^n Z(\mathcal{X}_{ij}) \quad (5)$$

where

$$Z(\mathcal{X}_{ij}) = p_{ij}^0 + z p_{ij}^1 + z^2 p_{ij}^2 + z^3 p_{ij}^3 + \dots \quad (6)$$

Then, the number of blocks accessed from the most heavily loaded disk⁵ is given by

$$\mathcal{N}_{\max} = \max(\mathcal{N}_1, \mathcal{N}_2, \dots, \mathcal{N}_D) \quad (7)$$

Due to the round robin nature of media stream placement, the number of blocks accessed from a disk is not independent of the load on its neighboring disks. Since the precise dependence of these random variables on each other is difficult to characterize, and since the maximum of D dependent random variables is difficult to compute, as an approximation we assume that \mathcal{N}_j s are independent of each other. Later in this section, we demonstrate that this approximation does not cause any inaccuracies in the predictions of the model. Then, the distribution of \mathcal{N}_{\max} can be computed as

$$F_{\mathcal{N}_{\max}}(x) = F_{\mathcal{N}_1}(x) \cdot F_{\mathcal{N}_2}(x) \cdot \dots \cdot F_{\mathcal{N}_D}(x) \quad (8)$$

where $F_{\mathcal{N}_j}$ is the cumulative probability distribution function of the random variable \mathcal{N}_j [16].

Having determined the distribution of the number of blocks accessed from the most heavily loaded disk, the service time of the disk can then be computed by using a disk model. We use one such model that has been proposed in the literature [14, 22] (see Appendix A for the complete disk model). The service time to access \mathcal{N}_{\max} blocks of size B as predicted by the disk model is:

$$\tau_{\max} = \mathcal{N}_{\max} \cdot (t_s + t_r) + \mathcal{N}_{\max} \cdot B \cdot t_t \quad (9)$$

where t_s and t_r denote the seek time and rotational latency incurred while accessing a block from disk and t_t denotes the transfer time for a unit amount of data.

Thus, given the server configuration and the workload characteristics, the model computes the service time distribution of the most heavily loaded disk for a particular block size. Moreover, the model also yields the distribution of the number of blocks accessed from a disk with average load (i.e., \mathcal{N}_j). The service time of such a disk can then be computed using the disk model.

2.1.2 A Model for Redundant Arrays

Since disk arrays are highly susceptible to disk failures, multimedia servers employ redundancies in data storage to guarantee high availability of data. Most redundant arrays are based on the *Redundant Array of Independent Disks (RAID)* architecture [6, 17]. RAID arrays compute redundant blocks (referred to as *parity*) by taking an exclusive-or operation over data blocks stored on $G - 1$ disks, where $G > 2$, and store it on another disk. The parity block together with all the data blocks over which parity is computed is referred to as a *parity group*. In the presence of a disk failure (also referred to as the degraded mode), the server reconstructs a block stored on the failed disk by

⁴The z-transform of a random variable \mathcal{U} is the polynomial $Z(\mathcal{U}) = a_0 + z a_1 + z^2 a_2 + \dots$ where the coefficient of the i^{th} term in the polynomial represents the probability that the random variable equals i . That is, $P(\mathcal{U} = i) = a_i$. If $\mathcal{U}_1, \mathcal{U}_2, \dots, \mathcal{U}_n$ are n independent random variables, and $\mathcal{Y} = \sum_{i=1}^n \mathcal{U}_i$, then $Z(\mathcal{Y}) = \prod_{i=1}^n Z(\mathcal{U}_i)$. The distribution of \mathcal{Y} can then be computed using a polynomial multiplication of the z-transforms of $\mathcal{U}_1, \mathcal{U}_2, \dots, \mathcal{U}_n$ [16].

⁵Note that the disk that is most heavily loaded will vary from one round to another. Regardless of which disk is the most heavily loaded in a particular round, \mathcal{N}_{\max} represents its load.

accessing the parity block and data blocks of the parity group stored on surviving disks. A commonly used RAID architecture is RAID-5 which uses block-interleaved parity and uniformly distributes parity blocks across disks in the array. The multiple RAID-5 architecture is an extension of the RAID-5 array in which the array is partitioned into clusters of disks, with each cluster independently computing parity information [6]. In the rest of this section, we assume a multiple RAID-5 architecture for our model. However, the basic approach used in our model is applicable to other RAID architectures as well.

Consider a multimedia server servicing n clients from a RAID-5 array consisting of D disks. Let G denote the parity group size, where $G \leq D$. Then the array contains $P = D/G$ clusters. Let us assume that the server computes parity blocks over a sequence of successive blocks from the same media stream (i.e., all data blocks of a parity group are consecutive blocks of the same media stream). Consequently, the server stores successive blocks of a media stream on disks storing data blocks of the parity group and skips over disks storing the parity blocks. Since each of the P clusters contains a disk storing a parity block, a request for more than $D - P$ consecutive blocks causes a disk to be reaccessed.

Fault-free Case

To compute the service time of the most heavily loaded disk in the fault-free mode, let b_i^k denote the probability that client i accesses k blocks from the array during a round, and let p_{ij}^k denote the probability that client i accesses k blocks from disk j during a round. To compute p_{ij}^1 , note that client i will access disk j only if disk j stores a data block (i.e., does not store a parity block). Moreover, client i will access a block from disk j if: (1) it requests m blocks ($1 \leq m \leq D - P$) from the array and the first of these blocks is stored on disk j or any of the previous $m - 1$ disks storing data blocks; or (2) it requests $D - P + m$ blocks ($1 \leq m < D - P$) from the array and the first of these blocks is stored on any disk storing data blocks other than disk j or any of the previous $m - 1$ disks. Since parity blocks are uniformly distributed across disks, one out of every G blocks stored on a disk is a parity block. Hence, the probability that disk j stores a data block is $(1 - 1/G)$. Due to the VBR nature of media streams, the first block is equally likely to be accessed from any of the $D - P$ disks storing data blocks. Hence, we get

$$p_{ij}^1 = (1 - \frac{1}{G}) \cdot \left(\sum_{m=1}^{D-P} b_i^m \cdot \frac{m}{D-P} + \sum_{m=1}^{D-P-1} b_i^{(D-P)+m} \cdot \frac{D-P-m}{D-P} \right) \quad (10)$$

Generalizing, the probability that client i accesses k blocks from disk j is

$$p_{ij}^k = (1 - \frac{1}{G}) \cdot \left(\sum_{m=1}^{D-P} b_i^{(k-1) \cdot (D-P) + m} \cdot \frac{m}{D-P} + \sum_{m=1}^{D-P-1} b_i^{k \cdot (D-P) + m} \cdot \frac{D-P-m}{D-P} \right) \quad (k = 1, 2, 3, \dots) \quad (11)$$

Since $P = \frac{D}{G}$, $(1 - \frac{1}{G})$ can be rewritten as $\frac{D-P}{D}$. Substituting this value in the above equation and simplifying, we get

$$p_{ij}^k = \sum_{m=1}^{D-P} b_i^{(k-1) \cdot (D-P) + m} \cdot \frac{m}{D} + \sum_{m=1}^{D-P-1} b_i^{k \cdot (D-P) + m} \cdot \frac{D-P-m}{D} \quad (k = 1, 2, 3, \dots) \quad (12)$$

Let \mathcal{X}_{ij} be the random variable representing the number of blocks accessed by client i from disk j during a round. Then $P(\mathcal{X}_{ij} = k) = p_{ij}^k$. Using this distribution of \mathcal{X}_{ij} , the distributions of the number of blocks accessed and the service time of the most heavily loaded disk in the fault-free state can be derived using the method presented in Section 2.1.1.

Failure Case

To compute the service time of the most heavily loaded disk in degraded mode, assume that disk f in the array experiences a failure, where $1 \leq f \leq D$. Since each cluster independently computes parity, disks that do not belong

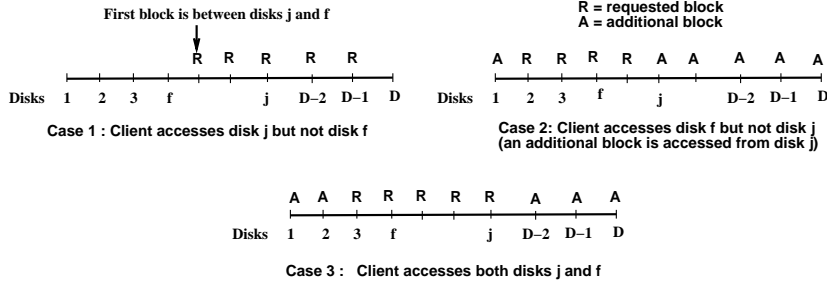

Figure 3: Different scenarios in which client i accesses a block from disk j in degraded mode.

to the cluster containing disk f are unaffected by this failure, and hence, for these disks, the number of blocks accessed in a round is the same as that in the fault-free state. All disks belonging to the cluster containing disk f , however, will experience an increase in load whenever a client accesses a block from disk f . To compute the number of blocks accessed by client i from disk j belonging to the cluster containing disk f , let δ denote the number of disks storing data blocks contained between disks j and f (including disk j), and let Δ denote the number of disks storing data blocks not contained between disks j and f . Observe that, if no parity block is stored on a disk between disks j and f , then $\delta = |j - f|$. Otherwise $\delta = |j - f| - 1$. In either case, $\Delta = D - P - \delta$.

To compute p_{ij}^1 , note that client i will access exactly one block from disk j if it requests m blocks from the array and one of the following three conditions hold: (1) a block is requested from disk j but not from disk f , or (2) a block is requested from disk f but not from disk j (and hence, a block must be accessed from disk j to reconstruct the block on disk f), or (3) a block is requested from both disks j and f and both blocks belong to the same parity group (and hence, no additional block needs to be accessed from disk j). Figure 3 illustrates these cases for an array with $G = D$.

To compute the probability that client i accesses disk j but not disk f , let us first consider the case when $f < j$. Client i will access disk j only if disk j stores a data block of the parity group. Moreover, client i will access a block from disk j but not disk f if: (1) it requests m blocks ($1 \leq m \leq \delta$) from the array and the first of these blocks is stored on disk j or any of the previous $m - 1$ disks; or (2) it requests $\delta + m$ blocks ($1 \leq m \leq \Delta - \delta$) from the array and the first of these blocks is stored on disk j or any of the previous $\delta - 1$ disks; or (3) it requests $\Delta + m$ blocks ($1 \leq m \leq \delta - 1$) from the array and the first of these blocks is stored on disk j or any of the previous $\delta - m - 1$ disks. A similar argument holds for the case when $f > j$, except that we must consider the last block accessed by the client instead of the first block. Since the first (last) block is equally likely to be stored on any of the $D - P$ disks storing data blocks, and since the probability that disk j stores a data block is $(1 - \frac{1}{G})$, we get

$$p' = (1 - \frac{1}{G}) \cdot \left(\sum_{m=1}^{\delta} b_i^m \cdot \frac{m}{D-P} + \sum_{m=1}^{\Delta-\delta} b_i^{\delta+m} \cdot \frac{\delta}{D-P} + \sum_{m=1}^{\delta} b_i^{\Delta+m} \cdot \frac{\delta-m}{D-P} \right) \quad (13)$$

Substituting $\frac{D-P}{D}$ for $(1 - \frac{1}{G})$ in the above equation and simplifying, we get

$$p' = \sum_{m=1}^{\delta} b_i^m \cdot \frac{m}{D} + \sum_{m=1}^{\Delta-\delta} b_i^{\delta+m} \cdot \frac{\delta}{D} + \sum_{m=1}^{\delta} b_i^{\Delta+m} \cdot \frac{\delta-m}{D} \quad (14)$$

By symmetry, the probability that client i accesses disk f but not disk j is the same as the probability that it accesses disk j but not disk f .

To compute the probability that client i accesses a block from both disks j and f , observe that the client must request at least δ blocks from the array (see Figure 3). Moreover, to be able to access disk j and f both disks j and f must store data blocks. Hence, the client accesses blocks belonging to the same parity group from disks j and f if (1) it requests $(m + \delta)$ blocks from the array, ($0 \leq m \leq \Delta$) and the first of these blocks is stored on a disk not

contained between disks j and f ; or (2) it accesses $(D - P + m)$ blocks and the first of these blocks is stored on a disk such that only one block is accessed from disks j and f . Since two out of every G parity groups will store a parity block on disks j or f , the probability that neither disk j nor disk f stores a parity block is $(1 - \frac{2}{G})$. Hence, the probability of accessing blocks belonging to the same parity group from disks f and j is

$$p'' = (1 - \frac{2}{G}) \cdot \left(\sum_{m=0}^{\Delta} b_i^{m+\delta} \cdot \frac{m+1}{D-P} + \sum_{m=1}^{\Delta} b_i^{D-P+m} \cdot \frac{\Delta-m+1}{D-P} \right) \quad (15)$$

Hence, summing the probability of the three cases, we get $p_{ij}^1(\delta, \Delta) = 2 \cdot p' + p''$, That is,

$$\begin{aligned} p_{ij}^1(\delta, \Delta) &= 2 \cdot \left(\sum_{m=1}^{\delta} b_i^m \cdot \frac{m}{D} + \sum_{m=1}^{\Delta-\delta} b_i^{\delta+m} \cdot \frac{\delta}{D} + \sum_{m=1}^{\delta} b_i^{\Delta+m} \cdot \frac{\delta-m}{D} \right) + \\ &\quad (1 - \frac{2}{G}) \cdot \left(\sum_{m=0}^{\Delta} b_i^{m+\delta} \cdot \frac{m+1}{D-P} + \sum_{m=1}^{\Delta} b_i^{D-P+m} \cdot \frac{\Delta-m+1}{D-P} \right) \end{aligned} \quad (16)$$

The value of p_{ij}^1 computed in the above equation is a function of parameters δ and Δ . Depending on whether or not a parity block is stored on a disk between disks j and f , we have two cases. If a parity block is stored on a disk between disks j and f , then we get $\delta_1 = |j - f| - 1$ and $\Delta_1 = D - P - \delta_1$. Since parity blocks are uniformly distributed across disks in the array, and the probability that of this case is $\frac{\delta_1}{G}$. If no parity block is stored between disks j and f , then we get $\delta_2 = |j - f|$ and $\Delta_2 = D - P - \delta_2$, and the probability of this case is $(1 - \frac{\delta_1}{G})$.

Hence, the overall probability that client i accesses one block from disk j is

$$p_{ij}^1 = \frac{\delta_1}{G} \cdot p_{ij}^1(\delta_1, \Delta_1) + (1 - \frac{\delta_1}{G}) \cdot p_{ij}^1(\delta_2, \Delta_2) \quad (17)$$

Generalizing, the probability that client i accesses k blocks from disk j is

$$p_{ij}^k = \frac{\delta_1}{G} \cdot p_{ij}^k(\delta_1, \Delta_1) + (1 - \frac{\delta_1}{G}) \cdot p_{ij}^k(\delta_2, \Delta_2) \quad (18)$$

where

$$\begin{aligned} p_{ij}^k(\delta, \Delta) &= 2 \cdot \left(\sum_{m=1}^{\delta} b_i^{m+\alpha} \cdot \frac{m}{D} + \sum_{m=1}^{\Delta-\delta} b_i^{\delta+m+\alpha} \cdot \frac{\delta}{D} + \sum_{m=1}^{\delta} b_i^{\Delta+m+\alpha} \cdot \frac{\delta-m}{D} \right) + \\ &\quad (1 - \frac{2}{G}) \cdot \left(\sum_{m=0}^{\Delta} b_i^{m+\delta+\alpha} \cdot \frac{m+1}{D-P} + \sum_{m=1}^{\Delta} b_i^{D-P+m+\alpha} \cdot \frac{\Delta-m+1}{D-P} \right) \end{aligned} \quad (19)$$

and $\alpha = (k - 1) \cdot (D - P)$. Let \mathcal{X}_{ij} be the random variable representing the number of blocks accessed by client i from disk j during a round. Then $P(\mathcal{X}_{ij} = k) = p_{ij}^k$. Then, using this distribution of \mathcal{X}_{ij} , the distribution of the number of blocks accessed and the service time of the most heavily loaded disk in the degraded mode can be derived in a manner similar to that in Section 2.1.1.

2.2 Validation of the Models

To validate our models, we have built an event-based, trace-driven disk array simulator called *DiskSim*.⁶ We digitized a number of traces and used these traces to run simulations over a wide range of system parameters (e.g., different number of clients, different number of disks, different round durations, etc.). The characteristics of the traces are

⁶The source code for *DiskSim* is publicly available from <http://www.cs.utexas.edu/users/dmcl/software/disksim>.

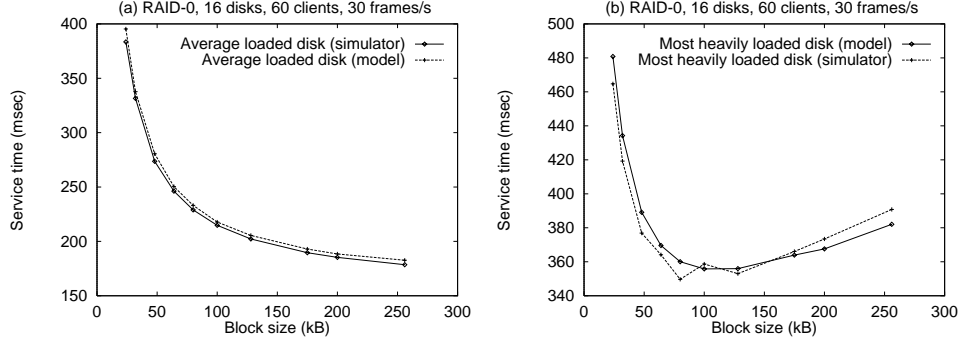

Figure 4: Variation in the service time of the average loaded disk and the most heavily loaded disk.

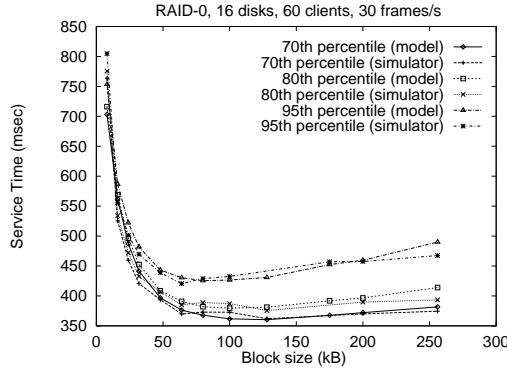

Figure 5: Validation of the model for various percentiles of the service time.

listed in Table 1. For each combination of parameters, we conducted multiple simulation runs and computed the 95% confidence intervals of the expected number of blocks accessed and the expected service time of the most heavily loaded disk. To validate the model for non-redundant arrays, we computed the expected number of blocks accessed and the expected service time of the most heavily loaded disk for each workload. The values predicted by the model were found to be within the 95% confidence intervals obtained from simulations. Figures 4(a) and (b) plot these values for one such workload. Similar results were obtained for various percentiles of the service time of the most heavily loaded disk (see Figure 5). The model for redundant arrays was validated similarly [19]. Thus, the simulation results validate the predictions made by our analytical models over a large parameter space.

The service time graphs of the average loaded disk and the most heavily loaded disk in Figure 4 lead us to the following observations:

- As shown in Figure 4(a), the service time of the average loaded disk decreases monotonically with increasing block size. This is because increasing the block size decreases the number of blocks accessed from the disk, thereby reducing disk seek and rotational latency overheads.
- The service time of the most heavily loaded disk, on the other hand, decreases initially and then starts increasing with increase in block size (see Figure 4(b)). To explain this behavior, let us first introduce some terminology. Let $\widehat{\mathcal{N}}_{\max}$ and $\widehat{\tau}_{\max}$, respectively, denote the expected number of blocks accessed from the most heavily loaded disk and the expected service time of the most heavily loaded disk during a round, and let $\widehat{\tau}_{\text{avg}}$ denote the expected service time of the average loaded disk. Then, the imbalance in the service times of the most heavily loaded disk and the average loaded disk \mathcal{I}_s (referred to as the load imbalance) is defined as

$$\mathcal{I}_s = \frac{\widehat{\tau}_{\max} - \widehat{\tau}_{\text{avg}}}{\widehat{\tau}_{\max}}$$

Table 1: Characteristics of Video Traces

MPEG File	Encoding Pattern	Length (frames)	Frame rate	Bit rate Mb/s
Frasier	$I(BBP)^3BB$	5960	30	1.49
Newscast	$I(BBP)^3BB$	9000	30	2.33
Flintstones	$I(BBP)^3BB$	9000	30	1.67

$$= 1 - \frac{\hat{\tau}_{\text{avg}}}{\hat{\tau}_{\text{max}}} \quad (20)$$

From (9), the portion of the service time spent in disk seek and rotational latency is $\hat{\mathcal{N}}_{\text{max}} \cdot (t_s + t_r) = \hat{\tau}_{\text{max}} - \hat{\mathcal{N}}_{\text{max}} \cdot B \cdot t_t$. Hence, the overhead due to seek and rotational latency \mathcal{O} can be defined as:

$$\begin{aligned} \mathcal{O} &= \frac{\hat{\tau}_{\text{max}} - \hat{\mathcal{N}}_{\text{max}} \cdot B \cdot t_t}{\hat{\tau}_{\text{max}}} \\ &= 1 - \frac{\hat{\mathcal{N}}_{\text{max}} \cdot B \cdot t_t}{\hat{\tau}_{\text{max}}} \end{aligned} \quad (21)$$

Assuming a fixed server configuration and workload characteristics, increasing the block size decreases the number of blocks accessed from the array. The smaller the number of blocks being accessed, the smaller is the probability of achieving equitable distribution of load across disks (since the array becomes sparsely loaded). Hence, increasing block size yields an increase in the load imbalance \mathcal{I}_s . On the other hand, increasing the block size causes the seek and rotational latency overhead to decrease. Figure 6 shows these variations in \mathcal{I}_s and \mathcal{O} .

For each media block size, the service time of the most heavily loaded disk is governed by the relative values of \mathcal{I}_s and \mathcal{O} . As shown in Figure 6, at small block sizes, the latency overhead dominates, and hence the service time decreases with increase in block size. At large block sizes, the load imbalance dominates the latency overhead, and causes the service time to increase with increase in block size. Consequently, the service time of the most heavily loaded disk decreases initially and then starts increasing with increase in block size.

From the above analysis, we conclude that minimizing the service time of the average loaded disk requires the server to choose a block size that is as large as possible. In contrast, minimizing the service time of the most heavily loaded disk requires the server to choose a block size that minimizes the combined effects of \mathcal{I}_s and \mathcal{O} . To maximize the number of clients supported for best-effort workloads, the server must minimize the service time of the average loaded disk, while for continuous media workloads, minimizing the service time of the most heavily loaded disk is more desirable. Hence, the optimal block size obtained for the two environments can differ significantly.

The precise value of the optimal block size for a continuous media workload depends on the quality of service requirements of clients and the values of various system parameters (such as the number of clients, their playback rate, the number of disks, etc.). In what follows, we examine the effect of these factors on the optimal block size. For each parameter, we also compute the range of block sizes that yields a service time within $x\%$ of the minimum. The upper and lower bounds of this set of block sizes define the $x\%$ *optimal envelope* for the workload [3, 22]. By choosing a block size that is contained within the $x\%$ optimal envelope of all values of the parameter, the server can ensure performance that is within $x\%$ of the optimal regardless of the workload.

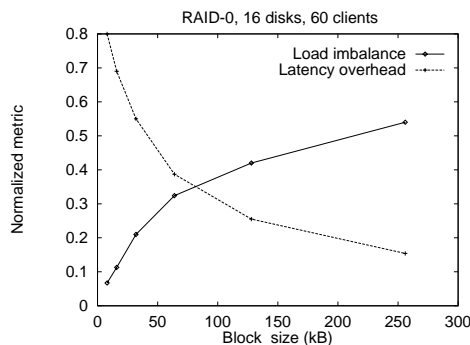

Figure 6: Variation in the load imbalance and the latency overhead.

2.3 Factors Affecting the Optimal Block Size

2.3.1 Effect of Quality of Service

Observe that, the model yields a distribution of the service time of the most heavily loaded disk in the array. To determine the optimal block size, the server must first choose a particular percentile of the service time as the metric and then compute the block size that minimizes that percentile. The choice of a particular percentile depends on the QoS requirements of clients (where QoS is defined to be the fraction of request deadlines that can be violated). For instance, the server can choose the expected value of the service time (which, in our experiments, approximately corresponds to the 70th percentile of the service time distribution) to determine the block size. In such a scenario, there is a 30% chance that the actual value of the service time during a round will exceed its expected value, resulting in a large number of request deadline violations. If clients have stringent quality of service (QoS) requirements (i.e., they can tolerate only rare violations of request deadlines), then the server must choose higher percentiles of the service time to provide the desired performance guarantees. For example, by choosing the 95th percentile of service time distribution of the most heavily loaded disk, the server can ensure that the service time does not exceed its estimated value in more than 5% of the rounds. Since different percentiles of the service time yield different optimal block sizes (see Figure 7(a)), the server must carefully choose an appropriate percentile of the service time as the metric based on the QoS requirements of clients.

Figure 7(b) shows the variation in optimal block size and the 5% optimal envelope for different percentiles of the service time. Larger percentiles of the service time correspond to more stringent QoS requirements. To provide stringent QoS, the server must minimize the variation in service times of the most heavily loaded disk across rounds. This can be achieved by selecting a block size which reduces the load imbalance. Since the load imbalance decreases with decrease in the block size (Figure 6), a small block size yields better performance for more stringent QoS requirements. Hence, the optimal block size and the 5% optimal envelope decrease with increase in percentile of the service time.

Observe from Figure 7(a) that, the service time of the most heavily loaded disk increases slowly for block sizes larger than the optimal block size. This might lead us to believe that choosing a block size that is larger than the optimal will yield near optimal performance, while reducing disk latency overheads. However, Figure 7(b) demonstrates that choosing the largest possible block size contained in the optimal envelope for a particular QoS degrades performance for more stringent QoS. For instance, choosing the upper 5% optimal envelope of the 70th percentile (i.e., 256KB) as the block size will cause a loss in performance for the 95th percentile (since 256KB is not contained in the 5% optimal envelope of the 95th percentile). This argument also shows that ad-hoc techniques that select a large block size (e.g., selecting the track size as the block size) can significantly affect the server performance, and hence, the number of clients supported. To achieve good performance over a range of QoS requirements, a block size that is contained within the $x\%$ optimal envelope of a wide range of percentiles must be chosen.

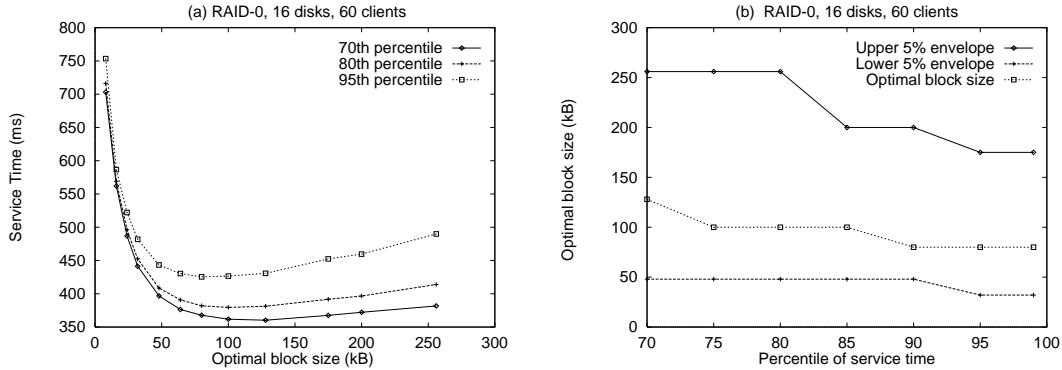

Figure 7: Effect of Quality of Service

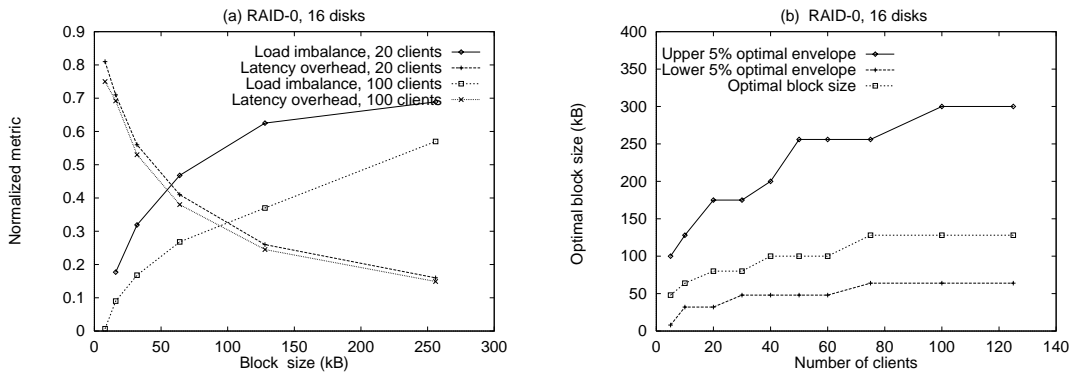

Figure 8: Effect of number of clients on the optimal block size.

2.3.2 Effect of system parameters

The model can also be used to study the effect of various system parameters on the optimal block size. Since the service time of the most heavily loaded disk is minimized when the combined effects of \mathcal{I}_s and \mathcal{O} are minimized, the effect of varying a system parameter on the optimal block size can be analyzed by studying its effect on \mathcal{I}_s and \mathcal{O} . We can intuitively understand the effect of a parameter on the optimal block size by assuming that the point of intersection of \mathcal{I}_s and \mathcal{O} governs the minima of the service time curve. Then, if a change in the value of the system parameter increases the number of blocks accessed from the array, it increases the probability of achieving equitable load distribution across disks, and hence, reduces \mathcal{I}_s . Such a reduction causes the \mathcal{I}_s curve to shift downward. This shifts the point of intersection of \mathcal{I}_s and \mathcal{O} (and hence, the minima of the service time curve) to the right, thereby increasing the optimal block size. On the other hand, if a change in the value of the parameter causes a decrease in the number of blocks per disk, then the load imbalance increases. Such an increase causes the point of intersection of the \mathcal{I}_s and \mathcal{O} curves to shift to the left, thereby reducing the optimal block size. To illustrate, consider the effect of variation in the number of clients on the optimal block size. For a fixed server configuration, increase in the number of clients increases the number of blocks accessed from the disk array, and thereby increases the probability of achieving equitable distribution of load across disks. This reduces the load imbalance \mathcal{I}_s , causing the \mathcal{I}_s curve to shift downwards. In contrast, the latency overhead curve, which is governed mostly by the physical characteristics of disks, shifts only marginally. This shifts the point of intersection of \mathcal{I}_s and \mathcal{O} curves to the right (see Figure 8(a)). Hence, the optimal media block size increases with increase in the number of clients accessing the server (see Figure 8(b)). The 5% optimal envelope also increases with increase in number of clients for similar reasons.

We have determined the effect of various system parameters, such as the number of disks, their physical characteristics, the playback rate of clients, the round duration, etc., on the optimal block size. The effect of all of these

Table 2: Effect of various parameters on the block size

Parameter	Effect of increase in parameter on optimal block size
Number of clients	Block size increases
Playback rate	Block size increases
Quality of Service (QoS)	Block size decreases
Number of disks	Block size decreases
Round duration	Block size increases
Disk zones	Block size increases from inner zones to outer zones
Parity Group Size	Block size increases

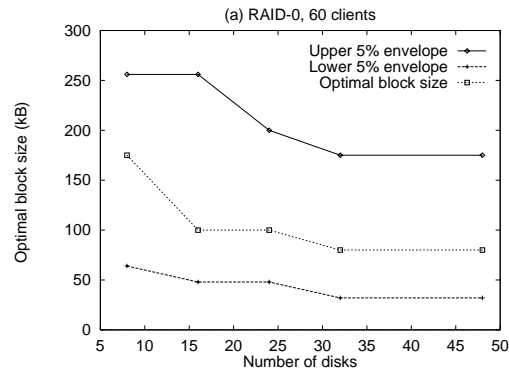

Figure 9: Effect of the number of disks on the optimal block size.

parameters on the optimal block size can be explained using arguments similar to those presented above. In what follows, we discuss our results in detail (Table 2 summarizes these results).

Number of Disks

For a fixed number of clients, increasing the number of disks in the system decreases the number of blocks accessed per disk. This decreases the probability of achieving equitable distribution of load across disks, and hence, increases the load imbalance \mathcal{I}_s . An increase in \mathcal{I}_s causes the \mathcal{I}_s curve to shift upwards and the point of intersection of \mathcal{I}_s and \mathcal{O} to shift to the left. Thus, the optimal block size decreases with an increase in the number of disks (see Figure 9).

Playback Rate and Round Duration

Assuming a fixed round duration (playback rate), increasing the playback rate (round duration) causes a client to request a proportionately larger amount of data per round to sustain continuous playback. This causes a larger number of blocks to be accessed from the array, thereby spreading the load across disks and reducing the load imbalance. Consequently, the optimal block size and the 5% optimal envelope increase with increase in playback rate (round duration). (see Figures 10(a) and 10(b)).

Disk Characteristics

To evaluate the effect of varying disk characteristics on the optimal block size, we first define the *work coefficient* of a disk [3]:

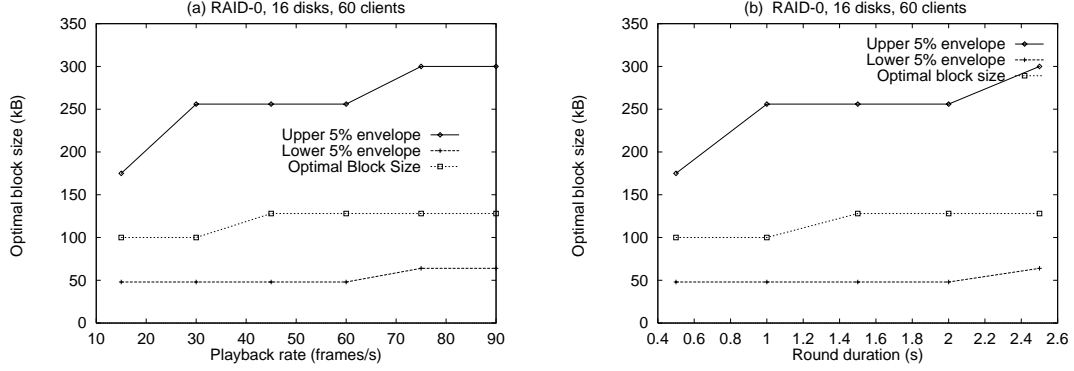

Figure 10: Effect of the playback rate of clients and the round duration on the optimal block size.

Table 3: Characteristics of various Seagate Disks

Model	Abbreviation	Capacity MB	Average seek (ms)	Avg Rotational latency (ms)	Transfer rate (MB/s)	Transfer time (ms/kB)	Work Coefficient
Medalist	M	631	14	7.87	4.875	0.2	9.2×10^{-3}
Hawk	H	1050	9	5.54	6.9	0.142	9.7×10^{-3}
Barracuda1	B1	2150	8	4.17	7.5	0.13	11×10^{-3}
Barracuda2	B2	4294	8	4.17	7.5	0.13	11×10^{-3}
Elite9	E9	9090	11	5.56	6.8	0.144	8.7×10^{-3}

Definition 1 The work coefficient of a disk is defined as

$$W = \frac{\text{time to transfer unit amount of data}}{\text{average seek} + \text{average rotational latency}} \quad (22)$$

The work coefficient measures the relative variation in the latency overheads and transfer times of disks. Table 3 shows the characteristics of various Seagate disks and their work coefficients.

Recall from (9) that

$$\hat{\tau}_{\max} = \hat{\mathcal{N}}_{\max} \cdot (t_s + t_r) + \hat{\mathcal{N}}_{\max} \cdot B \cdot t_t$$

Hence, from the definition of \mathcal{O} , we get:

$$\mathcal{O} = 1 - \frac{\hat{\mathcal{N}}_{\max} \cdot B \cdot t_t}{\hat{\tau}_{\max}} = \frac{(t_s + t_r)}{(t_s + t_r) + B \cdot t_t} = \frac{1}{1 + B \cdot \frac{t_t}{(t_s + t_r)}} = \frac{1}{1 + B \cdot W}$$

Hence, for a particular block size, increasing W decreases \mathcal{O} . This causes the point of intersection of the \mathcal{I}_s and \mathcal{O} curves to shift to the left. This indicates that the optimal block size varies inversely with the work coefficient. Figure 11(a) and Table 3 demonstrate this behavior for different Seagate disks.

Zoned Disks

Our experiments thus far assumed a single transfer rate for the entire disk. However, modern disks are partitioned into zones, with outer zones having higher recording densities and larger data transfer rates as compared to inner zones. Due to larger transfer rates (and hence, smaller transfer times), outer zones have a smaller work coefficient. Consequently, the optimal block size and the 5% optimal envelope for a zone increases as we proceed from inner zones to outer zones (see Figure 11(b)).

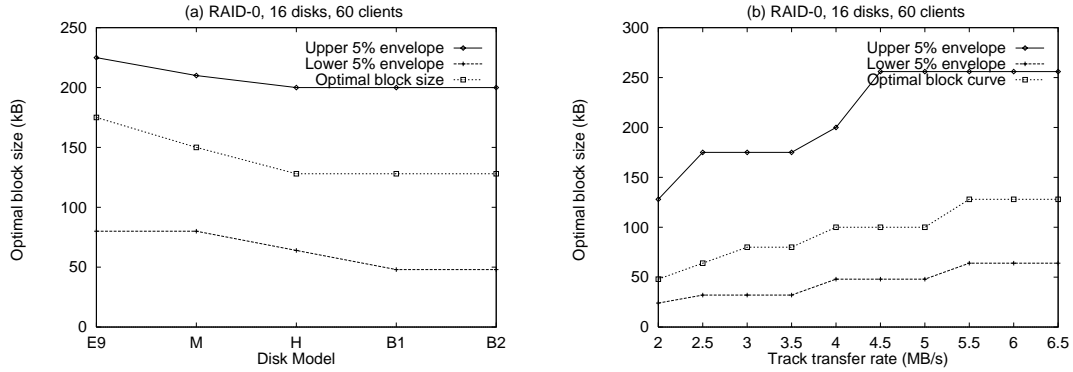

Figure 11: Variation in the optimal block size with disk characteristics. Figure (a) compares the optimal block size for different Seagate disks. Disks used in the experiment are Elite9, Medalist, Hawk, Barracuda1, and Barracuda2. Figure (b) shows the variation in the optimal block size for different transfer rates. Lower transfer rates represent inner zones.

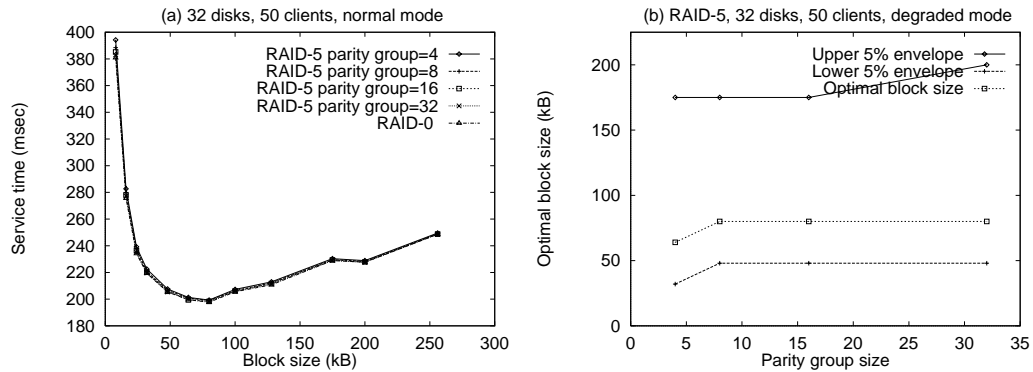

Figure 12: Effect of parity group size.

Since the optimal block size varies across zones, a multimedia server can: (i) choose an optimal block size for each zone, or (ii) choose a single block size for all zones. Recently several placement policies that employ different block sizes for different zones have been proposed [20, 21]. Our models enable us to parameterize these policies by choosing an appropriate block size for each zone. Since use of a single block size for all zones can cause an increase in the service time of the most heavily loaded disk, a multimedia server must choose a block size that minimizes this increase across all zones. To do so, the server must select a block size that is contained within the $x\%$ optimal envelope of all zones. This ensures that the service time of the most heavily loaded disk is always within $x\%$ of the minimum. To illustrate, Figure 11(b) shows that a block size of 96KB is contained within the 5% optimal envelope of all zones on the disk. Observe that these policies form two ends of a spectrum. Whereas one yields optimal performance, the other simplifies storage space management. The server can balance these tradeoffs by choosing an intermediate policy that groups consecutive zones and selects a single block size for each group.

Parity Group Size

Since non-redundant arrays do not maintain any parity information, the parity group size is a parameter that is relevant only to redundant disk arrays. Figure 12(a) depicts the service time of the most heavily loaded disk in a RAID-5 array in the normal operating mode. It demonstrates that, in the absence of a disk failure, the service time of the most heavily loaded disk in a RAID-5 array is almost identical to that obtained for an equivalent RAID-0 array. Moreover, the service time of the most heavily loaded disk is independent of the parity group size. Consequently,

the optimal block size obtained for a RAID-5 array in the normal operating mode is independent of the parity group size and is identical to that obtained for a RAID-0 array.

Next consider the RAID-5 array with a single disk failure. Let G denote the parity group size. In such a scenario, whenever a client accesses a block stored on the failed disk, the server must access the remaining blocks of the parity groups stored on the surviving $G - 1$ disks to reconstruct the requested block. Hence, with increase in parity group size, the number of additional blocks that must be accessed to reconstruct a block on the failed disk increases, increasing the load on surviving disks. This results in an *effective* increase in the playback rate of clients. As explained in earlier in this section, increasing the playback rate of clients causes an increase in the optimal media block size and the 5% optimal envelope. Hence, the optimal block size and the optimal envelope in the degraded mode increase with increase in the parity group size (see Figure 12(b)).

2.4 Selecting an Optimal Block Size

Having examined the effect of the server configuration and the workload characteristics on the block size, we now present procedures for selecting an optimal block size. The procedure for selecting an optimal block size depends on the design goals for the multimedia server, which in turn are dictated by the operating environment. To illustrate, for multimedia servers offering commercial services (e.g., video-on-demand, online news, etc.), the primary goal is to maximize revenue by maximizing the number of clients that can be supported by the server. In contrast, for multimedia servers which service clients with heterogeneous QoS, the number of clients that can be supported depends on the exact workload mix (i.e., the proportion of clients with different requirements). Since the workload mix can vary over time, the goal for such servers is to provide the best possible performance over a wide range of workloads. Differing design goals may require the system designer to choose completely different media block sizes.

To determine a block size that maximizes the number of clients supported, let us assume that all parameters determining the server configuration (i.e., the number of disks, their physical characteristics, the round duration, etc.) are known at design time. Also, assume that the data rate of clients and their QoS requirements are known. Then, a block size that maximizes the number of clients supported can be computed by the following two step procedure: (1) For a given number of clients, n , determine the service time of the most heavily loaded disk for different block sizes and select the block size that minimizes the service time; (2) If the service time of the most heavily loaded disk for this block size is less than the round duration, then increment n and repeat step (1). The block size that is obtained when the service time of the most heavily loaded disk equals the round duration maximizes the number of clients supported by the server.

In general computing environments, due to the heterogeneous nature of the workload, some of the workload characteristics may be unknown at design time (e.g., the number of clients accessing the server). In such a scenario, a block size that yields good performance over a wide range of workloads must be chosen [3]. For every parameter that is unknown at design time, the range over which the parameter is likely to vary must first be estimated. The optimal block size and the $x\%$ optimal envelope for each combination of these parameters is then computed using the model. Let $\mathcal{S}_1, \mathcal{S}_2, \dots$ denote sets, each containing the $x\%$ optimal envelope for a particular combination of these parameters. Then, the set of block sizes that yields service times within $x\%$ of the minimum over all possible combinations of these parameters is $\mathcal{S} = \mathcal{S}_1 \cap \mathcal{S}_2 \cap \dots$. If \mathcal{S} is empty, then the entire procedure must be repeated for a larger values of x until a non-empty set of block sizes is obtained. Figure 13 illustrates the process of computing a feasible solution (i.e., a non-empty set \mathcal{S}) over a range of client workloads.

3 Determining the Degree of Striping

In addition to determining the stripe unit size, defining a striping policy requires the determination of degree of striping. A multimedia server can either stripe a media stream across all disks in the array or across a subset of the disks. Whereas the former policy is referred to as *wide striping*, the latter policy is referred to as *narrow striping*.

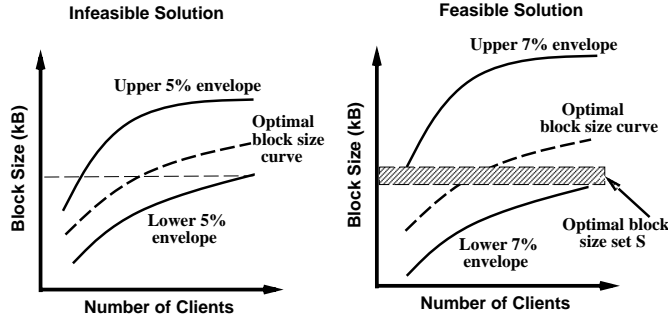

Figure 13: Selecting a block size that yields near-optimal performance, regardless of the number of clients accessing the server. The shaded region denotes the set of block sizes \mathcal{S} that yield service times within 7% of the minimum for all workloads.

To evaluate the relative merits of these policies, consider a multimedia server that employs wide striping to interleave media streams across disks in the array. Let us assume that the performance of the server is measured in terms of the maximum number of clients that it can support. In an ideal scenario, increase in the number of disks in the system should result in a linear increase in the number of clients that can be supported by the server. That is, the number of clients supported by a disk array consisting of D disks should be D times the number of clients that can be supported by a single disk. However, as shown in Figure 14(a), the number of clients supported by the server increases sub-linearly with increase in the number of disks. This can be attributed to the following two reasons:

- *Real-time requirements of clients:* Due to the real-time requirements of clients, the number of clients supported by the server is constrained by the most heavily loaded disk. Specifically, the number of clients accessing the server reaches its maximum value when the service time of the most heavily loaded disk equals the round duration. At this point, however, the service time of a disk with average load is smaller than the round duration. The resulting load imbalance causes most of the disks in the array to be under-utilized.
- *Reduction in optimal block size:* As explained in Section 2.3.2, an increase in the number of disks in the system causes the load imbalance \mathcal{I}_s to increase. An increase in the number of disks also increases the number of clients that can be supported by the server. Larger the number of clients accessing the server, the smaller the load imbalance \mathcal{I}_s . Thus, the combined effect of increasing the number of disks and the number of clients accessing the server governs the actual value of \mathcal{I}_s . Figure 14(b) plots the variation in imbalance \mathcal{I}_s against the (number of disks in the system, maximum number of clients supported) pairs. It illustrates that the increase in \mathcal{I}_s due to an increase in the number of disks dominates the decrease in \mathcal{I}_s due to an increase in the number of clients, causing the actual imbalance to increase. Hence, a small block size must be chosen to compensate for the increased imbalance, causing a decrease in the optimal block size (see Figure 14(c)). Since a small block size imposes a larger latency overhead, the overall throughput of the array decreases, causing a reduction in the number of clients that can be supported.

To minimize the impact of these factors, a server can: (1) partition the disk array into mutually exclusive groups of disks, and (2) stripe each media stream only within a partition. Since each partition acts as an independent disk array and the number of disks per partition is small, such an approach: (1) reduces the load imbalance within each partition, and (2) increases the optimal block size for a partition (and thereby reduces the latency overhead). In such partitioned arrays, load imbalances can occur if clients are not equitably distributed among all the partitions. Hence, the partition size must be chosen so as to simultaneously minimize the impact of load imbalance across partitions and the load imbalance within a partition. In what follows, we first present a model for determining the load imbalance across partitions, and then describe a procedure for determining the a partition size that maximizes the number of clients supported.

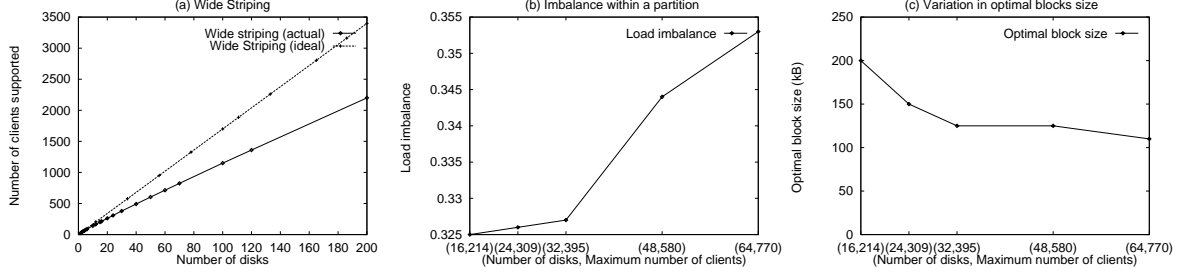

Figure 14: Loss in the number of clients supported in large disk arrays and factors contributing to this loss.

3.1 Modeling the Imbalance Across Partitions

To compute the load imbalance across partitions, consider a disk array consisting of D disks that is partitioned into groups of d disks each. Let us assume that the server employs a placement policy that assigns streams to partitions such that each partition is equally likely to be accessed by a new request [8, 23]. That is, the probability that a newly arriving client accesses a partition is $q = d/D$. In such a scenario, if n clients access the server, then the probability that m clients access the j^{th} partition is binomially distributed, and is given as:

$$P(\mathcal{Y}_j = m) = \binom{n}{m} \cdot q^m \cdot (1 - q)^{n-m} \quad (23)$$

where \mathcal{Y}_j is a random variable representing the number of clients accessing the j^{th} partition. Then the number of clients accessing the most heavily loaded partition is

$$\mathcal{Y}_{\max} = \max(\mathcal{Y}_1, \mathcal{Y}_2, \dots, \mathcal{Y}_{\frac{D}{d}}) \quad (24)$$

Since the load on a partition is independent of other partitions, $\mathcal{Y}_1, \mathcal{Y}_2, \dots, \mathcal{Y}_{\frac{D}{d}}$ are independent random variables. Hence, the distribution of \mathcal{Y}_{\max} can be computed as:

$$F_{\mathcal{Y}_{\max}}(x) = F_{\mathcal{Y}_1}(x) \cdot F_{\mathcal{Y}_2}(x) \cdots F_{\mathcal{Y}_{\frac{D}{d}}}(x) \quad (25)$$

where $F_{\mathcal{Y}_j}$ is the cumulative probability distribution function of the random variable \mathcal{Y}_j [16].

Given the distribution of \mathcal{Y}_i and \mathcal{Y}_{\max} , we can compute the expected number of requests on the average and the most heavily loaded partitions (denoted by $\hat{\mathcal{Y}}$ and $\hat{\mathcal{Y}}_{\max}$, respectively). Using these values, we can define the the load imbalance across partitions (denoted by \mathcal{I}_p) as:

$$\mathcal{I}_p = \left(1 - \frac{\hat{\mathcal{Y}}}{\hat{\mathcal{Y}}_{\max}} \right) \quad (26)$$

Thus, given the number of disks in the array and the partition size, we can compute the load imbalance across partitions.

3.2 Determining the Partition Size

For a fixed number of disks, increasing the partition size increases the load imbalance \mathcal{I}_s within a partition (Figure 14(b)), while decreasing the load imbalance \mathcal{I}_p across partitions (Figure 15). Moreover, as shown in Figure 14(c), increasing the partition size results in a reduction in the optimal block size (thereby increasing the seek and rotational latency overhead). Consequently, the server must determine the degree of striping (i.e., partition size) that balances these tradeoffs.

Given the models for predicting: (1) the load imbalance across partitions (Section 3.1), (2) the load imbalance within a partition (Section 2.1.1), a procedure for choosing a partition size that maximizes the number of clients supported by the server is as follows:

Procedure ComputePartitionSize

1. Choose an initial partition size of $d=1$.
2. Using the model presented in Section 2.1.1, compute the maximum number of clients, n' , that can be supported by a single partition of size d (i.e., the number of clients at which the service time of the most heavily loaded disk equals the round duration).
3. Assuming that n clients access the array, using the model presented in Section 3.1, compute the expected number of clients, \hat{Y}_{max} , accessing the most heavily loaded partition.
4. If $\hat{Y}_{max} < n'$, then increment n and repeat step (3). When $\hat{Y}_{max} = n'$, then n denotes the maximum number of clients that can be supported by the array with a partition size of d .
5. Increment the partition size d , and repeat steps (2) thorough (4) until no further improvements in the number of clients is obtained (i.e., until n starts decreasing with increase in d). This yields a partition size that maximizes the number of clients that can be supported.

In the above procedure, note that the limit on the number of clients that can be supported by the entire array is reached when the most heavily loaded partition reaches its maximum capacity. However, at this point, the number of clients accessing other partitions is less than their maximum capacity. Hence, the total number of clients that can be supported by the array does not increase linearly with number of partitions (i.e., $n < n' \cdot \frac{D}{d}$).

Figure 16(a) illustrates the result of executing this iterative procedure for an array of 120 disks. Since the number of clients that can be supported by the array is maximized at $d = 10$, the array should be partitioned into 12 partitions of 10 disks each for optimal performance. Figure 16(b) demonstrates the variation in the optimal partition size with increase in the number of disks in the array. Finally, Figure 16(c) illustrates the improvement in the number of clients supported due to partitioning. For small disk arrays, since wide striping is close to the ideal case, the additional gains due to partitioning are small. For large disk arrays, however, partitioning yields a approximately a 10% increase in the number of clients supported as compared to the wide striping. Figure 16(c) also demonstrates that partitioning coupled with static load balancing algorithms does not completely bridge the gap between the number of clients supported by the array in the ideal case (i.e., when the number of clients increases linearly with array size) and that obtained using wide striping. To further reduce the loss in the number of clients supported, the server must replicate streams across partitions and employ dynamic load balancing schemes. The improvement in performance yielded by such a scheme is at the expense of higher storage space requirement and more complex storage space management algorithms. Detailed cost-performance tradeoffs of such an approach is beyond the scope of this paper.

4 Related Work

Several research projects have developed simulation and analytical techniques for optimizing the performance of striped disk arrays for conventional workloads [3, 4, 5, 14]. As demonstrated in Section 1, due to the real-time nature of continuous media accesses, these techniques are not directly applicable for optimizing performance in multimedia servers.

The problem of determining the optimal stripe unit size for non-redundant arrays storing continuous media was studied in [22]. A model that predicts the service time of the most heavily loaded disk for non-redundant arrays (henceforth referred to as the VRG model) was also proposed in the paper. The VRG model uses worst case assumptions about the number of blocks accessed by a client during a round to compute the service time of the most heavily loaded disk. In contrast, our model uses actual distributions of the number of blocks accessed by a client

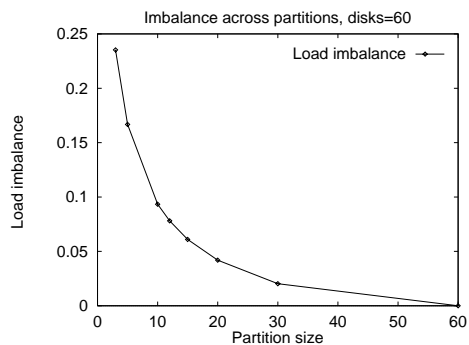

Figure 15: Variation in the imbalance across partitions with increase in the partition size

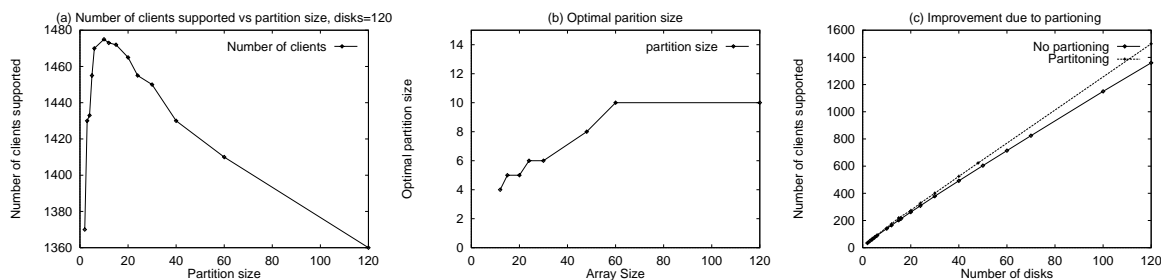

Figure 16: Partitioning large disk arrays.

during a round to compute the service time of the most heavily loaded disk. Due to worst-case assumptions, the service time predicted by the VRG model is higher than the actual service time of the most heavily loaded disk (see Figure 17(a)). Since the VRG model is conservative, as illustrated in 17(b), the optimal block size computed using the VRG model will cause the server to support a smaller number of clients. To derive this graph, we first computed the optimal block size using both models, and then determined the number of clients supported by the server using our model. If the VRG model were to be used to determine the number of clients supported by the server (in addition to using the model to compute the optimal block size), then the number of clients supported would be even lower. The problem of determining block size in redundant arrays or determining the degree of striping was not addressed in the paper.

The problem of determining the degree of striping has not received much attention in the literature. A comparison of wide and narrow striping schemes was presented in [10]. The focus of their effort was to evaluate the effect of

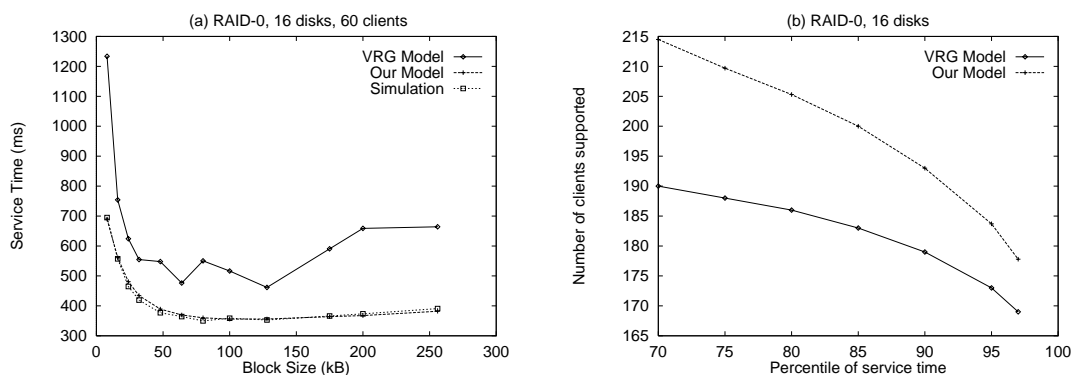

Figure 17: Comparison with the VRG model.

replicating media streams across array partitions on the response time. The problem of determining the partition size was not addressed in the paper. The problem of assigning media streams to array partitions subject so as to balance the load across partitions has been dealt in [8, 23]. These efforts complement our work since they do not deal with the issue of determining an optimal partition size for large disk arrays.

Many other striping related issues that are complementary to the problem addressed in this paper have been investigated. Striping techniques that minimize buffer requirements in continuous media servers have been proposed in [2, 7, 24]. Simulation studies of the cost-performance tradeoffs of striped continuous media servers were carried out in [2, 11]. These studies examine the tradeoffs of using different placement schemes in striped disk arrays. Striping in continuous media servers employing declustered parity arrays was investigated in [1]. A comparison of striping in RAID-3 and RAID-5 based continuous media servers was presented in [15]. The paper demonstrates that bit-interleaved RAID-3 arrays can cause a significant degradation in the number of clients supported as compared to block-interleaved RAID-5 arrays. A performance evaluation of striping techniques in an actual continuous media server based on RAID-3 arrays was presented in [13]. The paper investigates application level striping and disk driver level striping with respect to scalability and performance. The effect of fast-forward operations on the performance of striped continuous media servers was investigated in [9]. Finally, striping techniques for tertiary storage systems were analyzed in [12].

5 Concluding Remarks

In this paper, we have described techniques for determining the stripe unit size and the degree of striping for file servers storing continuous media data. To determine the optimal block size, we presented an analytical model that uses the server configuration and the workload characteristics to predict the load on the most heavily loaded disk in redundant and non-redundant arrays. We used the model to evaluate the effect of various parameters on the optimal block size. We also demonstrated that employing wide striping causes the number of clients supported to increase sub-linearly with increase in the number of disks. To maximize the number of clients supported in large arrays, we propose a scheme that partitions such arrays and stripes each media stream across a single disk partition. Since load imbalances can occur in partitioned arrays, we presented a model to determine the imbalance across partitions and described a procedure for determining a partition size that maximizes the number of clients supported by the array. The analytical models presented in this paper are the first to accurately characterize the load on the disk array for VBR streams. The only previously known model for VBR streams [22] uses worst case assumptions, and hence, yields sub-optimal results. Furthermore, our models can also be used by multimedia file servers to compute the number of clients that can be supported, which can then be used for admission control.

As part of future work, we plan to study the effect of large buffer caches and prefetching strategies on stripe unit size and degree of striping. We also plan to incorporate the results of our study to design and configure an integrated multimedia file server being built in our research laboratory.

References

- [1] S. Berson, S. Ghandeharizadeh, R. Muntz, and X. Ju. Staggered Striping in Multimedia Information Systems. In *Proceedings of ACM SIGMOD*, 1994.
- [2] E. Chang and A. Zakhor. Cost Analyses for VBR Video Servers. In *Proceedings of Multimedia Computing and Networking (MMCN) Conference*, pages 381–397, 1996.
- [3] P. Chen and D. Patterson. Maximizing Performance in a Striped Disk Array. *Proceedings of ACM SIGARCH Conference on Computer Architecture*, Seattle, WA, pages 322–331, May 1990.
- [4] P. M. Chen, G. A. Gibson, R. H. Katz, and D. A. Patterson. An Evaluation of Redundant Arrays of Disks using an Amdahl 5890. In *Proceedings of ACM SIGMETRICS*, pages 74–85, May 1990.
- [5] P. M. Chen and E. K. Lee. Striping in a RAID Level 5 Disk Array. In *Proceedings of the 1995 ACM SIGMETRICS Conference on Measurement and Modeling of Computer Systems*, May 1995.

- [6] P. M. Chen, E. K. Lee, G. A. Gibson, R. H. Katz, and D. A. Patterson. RAID: High-Performance, Reliable Secondary Storage. *ACM Computing Surveys*, pages 145–185, June 1994.
- [7] A. Cohen, W. A. Burkhard, and P. V. Rangan. Pipelined Disk Arrays for Digital Movie Retrieval. In *Proceedings of the International Conference on Multimedia Computing Systems (ICMCS)*, pages 312–317, 1995.
- [8] A. Dan and D. Sitaram. An Online Video Placement Policy based on Bandwidth to Space Ratio (BSR). In *Proceedings of ACM SIGMOD'95, San Jose, CA*, pages 376–385, May 1995.
- [9] J. K. Dey-Sircar, J. D. Salehi, J. F. Kurose, and D. Towsley. Providing VCR Capabilities in Large-Scale Video Servers. In *Proceedings of the Second ACM International Conference on Multimedia*, pages 25–32, October 1994.
- [10] R. Flynn and W. Tetzlaff. Disk Striping and Block Replication Algorithms for Video File Servers. In *Proceedings of the International Conference on Multimedia Computing Systems (ICMCS)*, pages 590–597, 1996.
- [11] S. Ghandeharizadeh and S. H. Kim. Striping in Multi-disk Video Servers. In *Proceedings of the SPIE High-Density Data Recording and Retrieval Technologies Conference*, Oct 1995.
- [12] L. Golubchik, R. R. Muntz, and R. W. Watson. Analysis of Striping Techniques in Robotic Storage Libraries. In *Proceedings of the 14th IEEE Symposium on Mass Storage Systems, Also Appeared as a poster at Supercomputing '94, Washington, D.C.*, November 1994.
- [13] J. Hsieh, M. Lin, J. C. L. Liu, and D. H. C. Du. Performance of A Mass Storage System for Video-On-Demand. *Journal of Parallel and Distributed Computing, Special Issue on Multimedia Processing and Technology (to appear)*, 1996.
- [14] E.K. Lee and R.H. Katz. An Analytic Performance Model for Disk Arrays. In *Proceedings of the 1993 ACM SIGMETRICS*, pages 98–109, May 1993.
- [15] B. Ozden, R. Rastogi, and A. Silberschatz. Disk Striping in Video Server Environments. In *Proceedings of the International Conference on Multimedia Computing Systems (ICMCS)*, pages 580–589, 1996.
- [16] A. Papoulis. *Probability, Random Variables, and Stochastic Processes*. McGraw Hill, 1991.
- [17] D. Patterson, G. Gibson, and R. Katz. A Case for Redundant Array of Inexpensive Disks (RAID). *ACM SIGMOD'88*, pages 109–116, June 1988.
- [18] J. Salehi, Z. Zhang, J. Kurose, and D. Towsley. Supporting Stored Video: Reducing Rate Variability and End-to-End Resource Requirements through Optimal Smoothing. In *Proceedings of SIGMETRICS '96, Philadelphia, PA*, May 1996.
- [19] P. J. Shenoy and H M. Vin. Efficient Striping Techniques for Multimedia File Servers. Technical Report TR96-27, Dept. of Computer Sciences, Univ. of Texas at Austin, 1996.
- [20] R. Tewari, R P. King, D. Kandlur, and D. Dias. Placement of Multimedia Blocks on Zoned Disks. In *Proceedings of ACM/SPIE Multimedia Computing and Networking (MMCN'96), San Jose*, January 1996.
- [21] S. Tong, Y. Huang, and J C. L. Liu. Study of Disk Zoning for Video Servers. In *Proceedings of the IEEE International Conference on Multimedia Computing and Systems (ICMCS'98), Austin, TX*, pages 86–95, June 1999.
- [22] H.M. Vin, S.S. Rao, and P. Goyal. Optimizing the Placement of Multimedia Objects on Disk Arrays. In *Proceedings of the Second IEEE International Conference on Multimedia Computing and Systems, Washington, D.C.*, pages 158–165, May 1995.
- [23] J. Wolf, P. S. Yu, and H. Shachnai. DASD Dancing- A Disk Load Balancing Optimization Scheme for Video-on-Demand Computer Systems. In *Proceedings of ACM SIGMETRICS'95*, pages 157–166, 1995.
- [24] P. Yu, M.S. Chen, and D.D. Kandlur. Design and Analysis of a Grouped Sweeping Scheme for Multimedia Storage Management. *Proceedings of Third International Workshop on Network and Operating System Support for Digital Audio and Video, San Diego*, pages 38–49, November 1992.

A Disk Model to Compute the Service Time

To compute the service time of a disk from the number of blocks obtained, we use a disk model that has recently proposed in the literature [14, 22]. Assuming that the disk employs the SCAN scheduling algorithm, the service time for accessing \mathcal{N} blocks of size B is:

$$\tau = \mathcal{N} \cdot (t_s + t_r) + \mathcal{N} \cdot B \cdot t_t$$

where t_s and t_r denote the seek time and rotational latency incurred while accessing a block from disk and t_t denotes the transfer time for a unit amount of data. Assuming that the \mathcal{N} blocks are uniformly distributed across the \mathcal{C} cylinders of a disk, the distance between two consecutive blocks is $\lfloor \frac{\mathcal{C}}{\mathcal{N}+1} \rfloor$ cylinders. Hence, we define $t_s = t_{seek} \left(\lfloor \frac{\mathcal{C}}{\mathcal{N}+1} \rfloor \right)$, where $t_{seek}(x)$ is the time to move the disk head across x consecutive cylinders and is computed as:

$$t_{seek}(x) = \begin{cases} 0 & \text{if } x = 0 \\ a\sqrt{x-1} + b(x-1) + c & \text{otherwise} \end{cases}$$

where a , b , and c are constants (determined using physical characteristics of a disk) [14]. The rotational latency, t_r , is defined to be half of the maximum rotational latency.